

2024  
**REPUESTOS  
DENTALES**

4ª Edición

Bienvenido

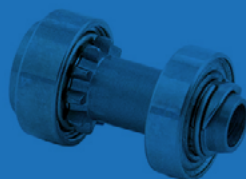

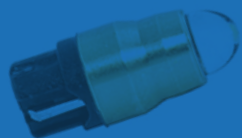
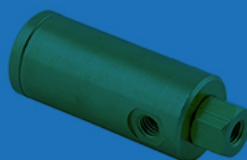
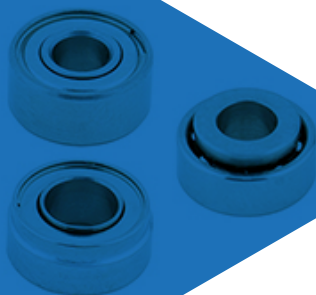
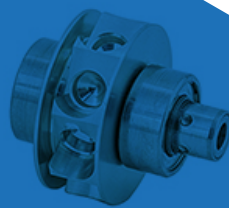



**2004 – 2024**

Mayorista dental en España y Portugal con venta exclusiva a Depósitos Dentales y Servicios Técnicos.



## ¿A qué nos dedicamos?

En RUMAR nos dedicamos desde el año 2004 a la importación de repuestos dentales y aparatología dental, y la distribución de repuestos, aparatología e instrumental médico odontológico exclusivamente a depósitos dentales y servicios técnicos.

*“Buenos precios. Gran selección. Servicio rápido.”*

## Definiciones previas

**Nuestro equipo:** profesionales al servicio de nuestros socios.

**Nuestros socios:** conjunto de servicios técnicos y depósitos que confían en nosotros. Ellos son la razón de nuestro existir.

**Un buen día:** haber atendido satisfactoriamente las necesidades de nuestros socios.

## Historia

**2004:** La semilla de nuestro proyecto es plantada por Margarita Crespo y Wolfgang Ade en Cedeira – A Coruña.

**2012:** Una nueva generación liderada por Alejandro Tuimil toma el relevo de la empresa y se traslada a Collado Villalba – Madrid.

**2018:** Se inauguran las nuevas instalaciones en Alpedrete – Madrid, con más de 320 m<sup>2</sup> al servicio de nuestros socios.

## Nuestro día a día

Somos un equipo de jóvenes profesionales dedicados a garantizar el mejor servicio y asesoramiento a nuestros socios.

Simplemente dedicamos nuestro día a día a hacer que el día a día de nuestros socios (depósitos dentales y servicios técnicos) sea más fácil, y convertirnos así en su aliado clave y nunca su competidor.

Parte del equipo RUMAR está dedicado constantemente a complementar nuestro stock y a hacer posible que mañana podamos atender las necesidades de nuestros socios mejor y más rápidamente.

El resto del equipo está dedicado a que hoy por hoy nuestros socios reciban lo que necesitan, cuándo y cómo lo necesitan.

# ▶ RECOMENDACIÓN PARA SUS BÚSQUEDAS

## Estimados Clientes,

Muchas gracias por su interés en nuestros productos.

En **RUMAR** contamos con más de 1.400 referencias entre todos nuestros productos y repuestos, por lo que en ocasiones puede complicarse la búsqueda de un determinado producto o repuesto. Para esas ocasiones, he aquí algunas recomendaciones útiles.

**1.** Como podrá apreciar, nuestros catálogos y listas de precios están generados en formato PDF (Adobe Acrobat). Este formato le permite utilizar un buscador automático que le facilitará su búsqueda. Para ello solamente debe seguir los siguientes pasos:

**a.** Abra nuestro catálogo o lista de precios de "Aparatología" o de "Repuestos" en función de la naturaleza de la referencia de su interés.

**b.** En la barra de herramientas en la cabecera de su pantalla es probable que encuentre una caja de texto de color blanco, con la palabra "Find" o "Buscar" en gris claro.

**c.** Como alternativa al paso "b" y si no encuentra el cuadro de texto en cuestión, diríjase al menú de "Tools" o "Herramientas" en la cabecera del documento. Aquí encontrará la opción: "Customize Toolbar" o "Personalizar barra de herramientas". Tras pinchar en esta opción, se abrirá un nuevo menú donde podrá marcar las opciones que desea visualizar en su pantalla. Seleccione la opción "Find Toolbar" o "Barra de Búsqueda". Tras esta operación deberá aparecer en su pantalla una caja de texto de color blanco, con la palabra "Find" o "Buscar" en gris claro.

**d.** Pinche en esta caja y escriba la referencia (RUMAR) del producto o repuesto de su interés o una palabra clave relacionada. Ejemplo: si Usted está interesado en unas escobillas para el K9, pruebe escribiendo escobilla o K9, y presione intro.

**2.** Esta búsqueda le posicionará en el primer lugar de todo el catálogo o la lista donde aparezca esta referencia o palabra. Si no es lo que Usted busca, vuelva a pulsar intro, y le llevará al siguiente lugar donde aparezca esta referencia o palabra. Repita estos pasos hasta que aparezca en pantalla lo que busca o hasta determinar que no contamos con ese producto o repuesto. En este último caso, consúltenos.

En caso de que los pasos 1 y 2 no sean fructíferos, a continuación le ofrecemos una segunda alternativa.

**3.** Diríjase al índice de nuestro catálogo. En él podrá encontrar de forma esquemática grupos y subgrupos de productos que le pueden ayudar en su búsqueda.

**4.** Tras ubicar el grupo o subgrupo al que pertenezca el producto o repuesto de su interés, diríjase a la página indicada y realice la búsqueda.

**Recuerde que siempre cuenta con la alternativa de contactar con nosotros:**

- **email:** [rumarcedeira@rumarcedeira.com](mailto:rumarcedeira@rumarcedeira.com)

- **Teléfono:** 918 49 01 04

## ¿Cómo reconocer en el catálogo

las novedades, bajadas de precio, referencias bajo pedido...?

▶ Novedad

▶ Bajada de precio

BAJO PEDIDO

HASTA AGOTAR

Nuevamente **gracias por su interés** en nuestros productos,  
y mucha suerte con su búsqueda y su negocio.

 **Siempre en Stock**  
**Entrega en 24 horas** 

**2024**  
**REPUESTOS**  
**DENTALES**

4ª Edición  
08 / Octubre / 2024

# CONTACTO



## ▶ Pedidos

Teléfono: 918 49 01 04  
e-mail: pedidos@rumarcedeira.com



## ▶ Att. al Cliente

Teléfono: 918 49 01 04 / 626 327 863  
e-mail: rumarcedeira@rumarcedeira.com



## ▶ Postventa

Teléfono: 918 49 01 04 / 618 051 894  
e-mail: postventa@rumarcedeira.com

## AVISO IMPORTANTE

RUMAR® se enorgullece de ofrecer repuestos originales de marcas líderes en el sector dental como: Luzzani®, Faro®, Metasys®, Dürr®, myonic®, Sirai® y ASCO pneumatics®, Clippard®, TKD®, Nouvag®, Micron®, Woodpecker®, DTE® y DCI®.

Y para el resto de marcas, RUMAR® ofrece piezas de recambio compatibles de comprobada calidad y durabilidad.

La empresa y sus productos no tienen ninguna relación con las siguientes empresas y marcas: Kavo®, Bien Air®, NSK®, Chirana Medical®, EMS®, Acteon®, Satelec®, Mectron®, W&H®, Siemens®, Sirona®, Castellini®, B.A. International®, Fona®, Planmeca®, Morita®, Saeshin®, Marathon®, Anthos®, Stern Weber®, Cefla®, Cattani®, Lares® y Fedesa®.

- Nos reservamos el derecho de modificar precios y características técnicas sin previo aviso. Para cerciorarse de estos posibles cambios, recomendamos revisar la información de la referencia que busca en nuestra web.
- Con cualquier pedido se acepta expresamente nuestras condiciones generales de venta disponibles en nuestra WEB.



[www.rumarcedeira.com](http://www.rumarcedeira.com)



# ÍNDICE

	Página
<b>RR</b> ▶ <b>REPUESTOS ROTATORIO</b> .....	<b>8</b>
<b>Alta Velocidad</b> (Turbinas y acoplamientos...):	
<ul style="list-style-type: none"><li>- Rotores turbina dental</li><li>- Rotores turbina laboratorio</li><li>- Tapas botón turbinas</li><li>- Tapas, difusores, toberas y tornillos spray</li><li>- Otros repuestos turbinas</li><li>- Juntas conexión turbinas, acoplamientos, micromotores</li><li>- LEDs y bombillas Xenon turbinas y acoplamientos</li><li>- Anillos tóricos y arandelas turbinas y acoplamientos</li><li>- Repuestos acoplamientos</li><li>- Rodamientos turbinas</li></ul>	
<b>Baja Velocidad</b> (Contra ángulos, piezas de mano, micromotores...):	
<ul style="list-style-type: none"><li>- Repuestos para contra ángulos y piezas de mano (Compatibles con KaVo®, NSK®, W&amp;H®, Bien Air®, Sirona®, MK-dent®, Castellini®, BA Internacional®, Woodpecker® / DTE®)</li><li>- Rodamientos para contra ángulos y piezas de mano (Compatibles con KaVo®, NSK®, W&amp;H®, Bien Air®, Sirona®, MK-dent®, RUMAR®)</li><li>- Repuestos para micromotores (Compatibles con KaVo®, NSK®, W&amp;H®, Bien Air®, Sirona®, MK-dent®, Saeyang Marathon®, Marathon®)</li><li>- Rodamientos para micromotores (Compatibles con KaVo®, NSK®, W&amp;H®, Bien Air®, Sirona®, MK-dent®, Saeyang Marathon®, Saeshin®)</li></ul>	
<b>FED</b> ▶ <b>NOVEDAD REPUESTOS FEDESA</b> .....	<b>107</b>
<ul style="list-style-type: none"><li>- Filtros para sillones Fedesa®</li><li>- Botoneras para sillones Fedesa®</li><li>- Válvulas, electroválvulas y otros para sillones Fedesa®</li><li>- Muelles para sillones Fedesa®</li><li>- Motores elevadores para sillones Fedesa®</li><li>- Varios repuestos para sillones Fedesa®</li><li>- Pistones para sillones Fedesa®</li></ul>	
<b>PSD</b> ▶ <b>NOVEDAD PISTONES SILLONES DENTALES</b> .....	<b>116</b>
<ul style="list-style-type: none"><li>- Pistones para sillones Fedesa®</li><li>- Pistones para sillones Sirona®</li></ul>	
<b>RLF</b> ▶ <b>REPUESTOS LÁMPARAS FARO</b> .....	<b>118</b>
<ul style="list-style-type: none"><li>- Repuestos lámpara Alya</li><li>- Repuestos lámpara Maia</li><li>- Repuestos lámpara EDI</li><li>- Repuestos lámpara Forma y otras</li></ul>	
<b>RAS</b> ▶ <b>REPUESTOS AUTOCLAVES Y SELLADORAS</b> .....	<b>127</b>
<b>RBV</b> ▶ <b>REPUESTOS BOMBAS DE VACÍO</b> .....	<b>131</b>
<b>JRJ</b> ▶ <b>JERINGAS Y REPUESTOS JERINGAS</b> .....	<b>133</b>
<ul style="list-style-type: none"><li>- Jeringas Luzzani y sus repuestos</li><li>- Jeringas FARO® y sus repuestos</li><li>- Jeringas económicas</li><li>- Puntas compatibles jeringas Cefla®, Kavo®, Sirona®, Luzzani®.</li></ul>	

	Página
<b>ME</b> ▶ <b>MANGUERAS EQUIPO</b> .....	<b>148</b>
<ul style="list-style-type: none"><li>- Mangueras turbinas con y sin conector a equipo</li><li>- Mangueras ultrasonidos con y sin conector a equipo</li><li>- Mangueras micromotores con y sin conector a equipo</li><li>- Accesorios mangueras</li><li>- Mangueras jeringas con y sin conector a equipo</li><li>- Mangueras pedales</li></ul>	
<b>RV</b> ▶ <b>REPUESTOS VARIOS</b> .....	<b>169</b>
<ul style="list-style-type: none"><li>- Repuestos Micron scaler SSS</li><li>- Repuestos pulidor bicarbonato Micron Quick Jet</li><li>- Repuestos lámparas quirófano Derungs®</li><li>- Repuestos Nouvag®</li><li>- Repuestos Woodpecker® y DTE®</li><li>- Repuestos lámparas fotocurado</li></ul>	
<b>RCD</b> ▶ <b>REPUESTOS COMPRESORES DÜRR DENTAL</b> .....	<b>201</b>
<b>SAR</b> ▶ <b>SISTEMAS DE ASPIRACIÓN Y REPUESTOS</b> .....	<b>205</b>
<ul style="list-style-type: none"><li>- Motores aspiración Luzzani® Dental y repuestos</li><li>- Motores aspiración, centrifugadoras y separadores de amalgama METASYS®</li><li>- Válvulas y accesorios METASYS®</li><li>- Repuestos aspiraciones METASYS®</li><li>- Conectores META connect (METASYS®)</li><li>- Motores aspiración, centrifugadoras y separadores de amalgama Dürr® Dental</li><li>- Repuestos aspiraciones Dürr® Dental</li><li>- Conectores Dürr® connect</li><li>- Soportes aspiración Luzzani® Dental</li><li>- Mangueras y tubos aspiración</li><li>- Terminales de aspiración y adaptadores</li></ul>	
<b>PR</b> ▶ <b>PEDALES Y SUS REPUESTOS</b> .....	<b>230</b>
<b>RCE</b> ▶ <b>RACORES, CONECTORES Y ESPIGAS</b> .....	<b>236</b>
<ul style="list-style-type: none"><li>- Racorería, conectores y llaves de paso</li><li>- Espigas</li><li>- Conectores de Nylon</li></ul>	
<b>VE</b> ▶ <b>VÁLVULAS Y ELECTROVÁLVULAS</b> .....	<b>251</b>
<ul style="list-style-type: none"><li>- Válvulas (Faro®, Clippard®, RUMAR®)</li><li>- Electroválvulas (Sirai® / ASCO NEUMATICS)</li></ul>	
<b>RP</b> ▶ <b>REGULADORES DE PRESIÓN</b> .....	<b>265</b>
<ul style="list-style-type: none"><li>- Reguladores y accesorios</li><li>- Repuestos depósito agua destilada</li></ul>	
<b>HE</b> ▶ <b>HERRAMIENTAS</b> .....	<b>269</b>
<ul style="list-style-type: none"><li>- Herramientas instrumental rotatorio</li><li>- Herramientas equipos</li></ul>	

## ▶ REPUESTOS ROTATORIO

### **Alta Velocidad** (Turbinas y acoplamientos):

- Rotores turbina dental
- Rotores turbina laboratorio
- Rodamientos turbinas
- Tapas botón turbinas
- Tapas, difusores, toberas y tornillos spray
- Otros repuestos turbinas
- Juntas conexión turbinas, acoplamientos, micromotores
- LEDs y bombillas Xenon turbinas y acoplamientos
- Anillos tóricos y arandelas turbinas y acoplamientos
- Repuestos acoplamientos

### **Baja Velocidad** (contra ángulos, piezas de mano, micromotores):

- Rodamientos contra-ángulos, piezas de mano y micromotores clínica
- Repuestos cabezas, contra ángulos, piezas de mano, micromotores neumáticos, acoplamientos
- Anillos tóricos contra ángulos, piezas de mano, micromotores y ultrasonidos
- Rodamientos micromotores eléctricos
- Rotores, escobillas, pinzas y otros repuestos micromotores eléctricos



# ROTORES RM





















## para TURBINA

---

- **Rodamientos cerámicos myonic®**, con tolerancias ABEC7 como mínimo.
- Balanceados electrónicamente.
- **Pinza de Acero** endurecido y anticorrosión.
- **Inserto** de Carburo o Acero según modelo.
- **Recubrimiento de WCC** (Wolframcardid) para una mayor vida útil de la pinza y sus componentes.
- **Aspa de Aluminio** sin plomo.
- **Concentricidad** < 0,018mm /
- **Balaceo** < 0,05mg mm.
- **Fuerza de retención mínima** 42 N.
- **Suministro incluye:** anillos tóricos y arandelas metálicas (según modelo).

(\*\*)Debido a su no disponibilidad, los rotores con (\*\*) junto a la referencia son rotores que aunque de muy buena calidad no son del mismo fabricante y / o no cuentan con rodamientos myonic® como el resto de nuestros rotores rm. En nuestro afán por atender la demanda de nuestros clientes hemos incorporado estos modelos de fabricantes alternativos, y a pesar de no contar con las mismas calidades, ofrecemos la **misma garantía: 12 meses sobre la pinza.**











Rotores compatibles turbinas KaVo®

	Modelos para KaVo®	Relacionados
 myonic	 <p>606B, 606C 625B, 625C SUPERtorque® 630B</p> <p>SUPERtorque® 630C SUPERtorque® 640B SUPERtorque® 640C</p> <p><b>Ref.: RM-2106</b> (Ref. KaVo: 0.553.5881)</p>	<p>Tapa Ref.: TT-6511 para 640 Tapa Ref.: TT-4041 para 630 Llave Ref.: HE-609</p> <p><b>148'00€</b></p>
 myonic	 <p>SMARTtorque® S605 SMARTtorque® S605C SMARTtorque® S615</p> <p>SMARTtorque® S615C</p> <p><b>Ref.: RM-2115</b> (Ref. KaVo: 1.008.4164)</p>	<p>Tapa Ref.: TT-7051 Llave Doble Ref.: HE-604</p> <p><b>148'00€</b></p>
 myonic	 <p>SUPERtorque® 650B SUPERtorque® 650C</p> <p><b>Ref.: RM-2116</b> (Ref. KaVo: 0.553.8051)</p>	<p>Tapa Ref.: TT-8061 Llave Doble Ref.: HE-604</p> <p><b>148'00€</b></p>
 myonic	 <p>CONTACTair® 632B CONTACTair® 632C CONTACTair® 632D</p> <p>Bella-Torque® 639B Bella-Torque® 639C Bella-Torque® 642B</p> <p>Bella-Torque® 642C Bella-Torque® 645B Bella-Torque® 645C</p> <p><b>Ref.: RM-2126</b> (Ref. KaVo: 0.553.6911)</p>	<p>Tapa Ref. 645: TT-7391 Tapa Ref. Resto: TT-5081 Llave Ref.: HE-609</p> <p><b>148'00€</b></p>
 myonic	 <p>Bella-Torque® 637B Bella-Torque® 637C Mira LUX 635</p> <p><b>Ref.: RM-2136</b> (Ref. KaVo: 0.553.8661)</p>	<p>Tapa Ref.: TT-8491 Llave Ref.: HE-1637T</p> <p><b>148'00€</b></p>
 myonic	 <p>SUPERtorque® 655B SUPERtorque® 655C SUPERtorque® 660B</p> <p>SUPERtorque® 660C</p> <p><b>Ref.: RM-2146</b> (Ref. KaVo: 1.000.2078)</p>	<p>Tapa Ref.: TT-2076 Llave Doble Ref.: HE-604</p> <p><b>148'00€</b></p>
 myonic	 <p>GENTLEsilence mini® 4500B GENTLEsilence mini® 4500C GENTLEsilence mini® 5000B</p> <p>GENTLEsilence mini® 5000C</p> <p><b>Ref.: RM-2154</b> (Ref. KaVo: 1.006.4564)</p>	<p>Tapa Ref.: TT-1079 Llave Doble Ref.: HE-604</p> <p><b>148'00€</b></p>
 myonic	 <p>GENTLEforce® 7000B GENTLEforce® 7000C</p> <p><b>Ref.: RM-2156</b> (Ref. KaVo: 1.000.4772)</p>	<p>Tapa Ref.: TT-2076 Llave Doble Ref.: HE-604</p> <p><b>148'00€</b></p>
 myonic	 <p>SMARTtorque® S619L SMARTtorque® S619C SMARTtorque® S609C</p> <p><b>Ref.: RM-2176</b> (Ref. KaVo: 1.008.4163)</p>	<p>Tapa Ref.: TT-2076 Llave Doble Ref.: HE-604</p> <p><b>148'00€</b></p>
 myonic	 <p>GENTLEsilence® 8000B GENTLEsilence® 8000C GENTLEsilence® 6500BR</p> <p><b>Ref.: RM-2186</b> (Ref. KaVo: 1.003.6884)</p>	<p>Tapa Ref.: TT-5525 Llave Doble Ref.: HE-604</p> <p><b>148'00€</b></p>

GARANTÍA de 12 meses sobre la pinza









SI NO ENCUENTRAS EL REPUESTO QUE BUSCAS, ¡CONSÚLTANOS!

Precios: impuestos, portes y mano de obra no incluidos.

Modelos para KaVo®		Relacionados
 Imagen no disponible	GENTLEsilence® 6500B	
 myonic	<b>Ref.: RM-2187</b> (Ref. KaVo: 1.003.9664)	<b>148'00€</b>
 myonic	POWERtorque® 646B POWERtorque® 646C POWERtorque® 646CP COMPACTtorque® 636B	COMPACTtorque® 636P COMPACTtorque® 636CP (excepto 636 C)
 myonic	<b>Ref.: RM-2196</b> (Ref. KaVo: 0.553.8911)	<b>148'00€</b>
 myonic	EXPERTtorque® E680 (Todos) EXPERTtorque® E679	
 myonic	<b>Ref.: RM-2168</b> (Ref. KaVo: 1.007.9313)	<b>148'00€</b>
 myonic	MASTERTorque® M9000 MASTERTorque® M9000L	
 myonic	<b>Ref.: RM-2190</b> (Ref. KaVo: 2.000.2266)	<b>148'00€</b>
 myonic	EXPERTtorque® E677 EXPERTtorque® E677LM EXPERTtorque® E675	
 myonic	<b>Ref.: RM-2170</b> (Ref. KaVo: 1.007.9457)	<b>148'00€</b>

## Rotores compatibles turbinas Bien Air®

RUMAR

Modelos para Bien Air®		Relacionados
 myonic	Croma M Ondine Prestilina	Prestige (antigua)
 myonic	<b>Ref.: RM-2446**</b> (Ref. Bien Air: 209.30.19)	<b>158'00€</b>
 myonic	Black Pearl Croma X S25	Croma S Boralina Black Pearl ECO
 myonic	<b>Ref.: RM-2456</b> (Ref. Bien Air: 150.0164)	<b>148'00€</b>
 myonic	Bora L Bora LED Bora LK	Bora S36 Bora Blackline Bora Blackline LK
 myonic	<b>Ref.: RM-2466</b> (Ref. Bien Air: 150.0181)	Rotamax L Tornado X (NO TU Bora 2 LED)
 myonic	Prestige S30 Prestige S32	
 myonic	<b>Ref.: RM-2476</b> (Ref. Bien Air: 150.0486)	<b>148'00€</b>

**GARANTÍA** de 12 meses sobre la pinza

**SI NO ENCUENTRAS EL REPUESTO QUE BUSCAS, ¡CONSÚLTANOS!**





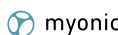



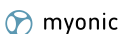

**Precios:** impuestos, portes y mano de obra no incluidos.

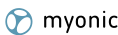
RUMAR

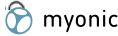
Modelos para Bien Air®		Relacionados
 	Eolia Black Pearl ECO (Confirmar con imagen)  <b>Ref.: RM-2486**</b>	<b>158<sup>00</sup>€</b>
 	Tornado  <b>Ref.: RM-2468</b> (Ref. Bien Air: 150.1968)	<b>148<sup>00</sup>€</b>  Tapa Ref.: TT-1835 Llave Ref.: HE-831 (N/S<16E0001)
 	Tornado S® (cabeza mini)  <b>Ref.: RM-2470**</b> (Ref. Bien Air: 150.1969)	<b>148<sup>00</sup>€</b>  Tapa Ref.: TT-1963 Llave Ref.: HE-846
  <small>Imagen no disponible</small>	Bora 2 LED/LK  <b>Ref.: RM-2472**</b> (Ref. Bien Air: 150.3003)	<b>148<sup>00</sup>€</b>  Tapa Ref.: TT-2999 Llave Ref.: HE-618

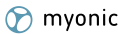
Rotores compatibles turbinas **Sirona® / Siemens®**

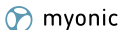









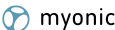

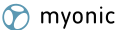

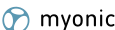

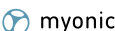

RUMAR

Modelos para Sirona® / Siemens®		Relacionados
 	Siemens® TM1® Siemens® 4000ML® Siemens® 4000M®  <b>Ref.: RM-2216</b> (Ref. Siemens®: 5951595)	<b>148<sup>00</sup>€</b>  Tapa Ref.: TT-4000 Llave Ref.: HE-591
 	TS1® TS2® 4000SL®  4000S® Siemens® T1 Control®  <b>Ref.: RM-2226</b> (Ref. Sirona®: 5953054)	<b>148<sup>00</sup>€</b>  Tapa Ref.: TT-4000 Llave Ref.: HE-591
 	T1 Control (N/S<502.000) TC3 Control (N/S<65.000)  <b>Ref.: RM-2236</b> (Ref. Sirona®: 4175217)	<b>148<sup>00</sup>€</b>  Tapa Ref.: TT-7595 Llave Ref.: HE-592
 	T2 Control (N/S<600.000) T1 Control (502.000<N/S<600.000) TC3 Control (65.000<N/S<700.000)  Siropure P Control  <b>Ref.: RM-2246</b> (Ref. Sirona®: 5868299, 5957126)	<b>148<sup>00</sup>€</b>  Tapa Ref.: TT-0884 Llave Ref.: HE-591
 	T1 Control (600.000<N/S<800.000)  <b>Ref.: RM-2238**</b> (Ref. Sirona®: 6432608)	<b>148<sup>00</sup>€</b>

**GARANTÍA** de 12 meses sobre la pinza

**SI NO ENCUENTRAS EL REPUESTO QUE BUSCAS, ¡CONSÚLTANOS!**





















**Precios:** impuestos, portes y mano de obra no incluidos.

	Modelos para Sirona® / Siemens®	Relacionados
 Imagen no disponible	T1 Control (N/S>800.000)	
	<b>Ref.: RM-2248</b> (Ref. Sirona: 6710367)	<b>148'00,€</b>
	T2 Control (600.000<N/S<800.000)	
	<b>Ref.: RM-2247**</b> (Ref. Sirona: 6432590)	<b>148'00,€</b>
 Imagen no disponible	T2 Control (N/S>800.000)	
	<b>Ref.: RM-2249**</b> (Ref. Sirona: 6710425)	<b>158'00,€</b>
	T2 Racer T3 Racer (N/S <600.000) Siropure P Racer (N/S <600.000)	<b>Tapa Ref.: TT-8897</b> <b>Llave Ref.: HE-591</b>
	<b>Ref.: RM-2256</b> (Ref. Sirona: 5868307)	<b>148'00,€</b>
	T3 Racer (N/S>600.000) T4 Racer (N/S>600.000)	<b>Tapa Ref.: TT-0212</b> <b>Llave Ref.: HE-612</b>
	<b>Ref.: RM-2257</b> (Ref. Sirona: 6486240)	<b>148'00,€</b>
	T1 mini (65.000<N/S<502.000) Siropure P mini <b>(Confirmar con imagen)</b>	<b>Llave Ref.: HE-591</b>
	<b>Ref.: RM-2260</b> (Ref. Sirona: 4178591)	<b>148'00,€</b>
	T2 mini (N/S <600.000)      Siropure P mini T3 mini (N/S<600.000) T1 mini (502.000<N/S<600.000) <b>(Confirmar con imagen)</b>	<b>Llave Ref.: HE-591</b>
	<b>Ref.: RM-2261</b> (Ref. Sirona: 5868315, 5868331)	<b>148'00,€</b>
 Imagen no disponible	T1 mini (600.000<N/S<700.000)	
	<b>Ref.: RM-2251**</b> (Ref. Sirona: 6432640)	<b>158'00,€</b> <b>BAJO PEDIDO</b>
 Imagen no disponible	T1 mini CBM (700.000<N/S<800.000)	
	<b>Ref.: RM-2252**</b> (Ref. Sirona: 6548106)	<b>148'00,€</b> <b>BAJO PEDIDO</b>
 Imagen no disponible	T1 mini (N/S>800.000)	
	<b>Ref.: RM-2253**</b> (Ref. Sirona: 6710417)	<b>158'00,€</b> <b>BAJO PEDIDO</b>

**GARANTÍA** de 12 meses sobre la pinza

**SI NO ENCUENTRAS EL REPUESTO QUE BUSCAS, ¡CONSÚLTANOS!**

**Precios:** impuestos, portes y mano de obra no incluidos.

Modelos para Sirona® / Siemens®		Relacionados
 myonic	 <p>T2 mini (600.000&lt;N/S&lt;700.000) T3 mini (600.000&lt;N/S&lt;700.000)</p> <p><b>Ref.: RM-2263**</b> (Ref. Sirona®: 6432632)</p> <p><b>148'00€</b></p>	<p><b>Tapa Ref.:</b> TT-0213 <b>Llave Ref.:</b> HE-592</p>
 myonic	 <p>T2 mini (700.000&lt;N/S&lt;800.000) T3 mini (700.000&lt;N/S&lt;800.000)</p> <p><b>Ref.: RM-2265**</b> (Ref. Sirona®: 6548130)</p> <p><b>158'00€</b></p>	<p><b>Tapa Ref.:</b> TT-0213 <b>Llave Ref.:</b> HE-592</p>
 myonic	 <p>Imagen no disponible</p> <p>T2 mini (N/S&gt;800.000) T3 mini (N/S&gt;800.000)</p> <p><b>Ref.: RM-2250**</b> (Ref. Sirona®: 6710441)</p> <p><b>148'00€</b></p>	
 myonic	 <p>Siroboost (Todos)</p> <p><b>Ref.: RM-2262</b> (Ref. Sirona®: 6334598)</p> <p><b>148'00€</b></p>	<p><b>Llave Ref.:</b> HE-591</p>
 myonic	 <p>Imagen no disponible</p> <p>T1 Boost (N/S&gt;600.000)</p> <p><b>Ref.: RM-2258**</b> (Ref. Sirona®: 6432624)</p> <p><b>148'00€</b></p>	<p><b>Tapa Ref.:</b> TT-0814 <b>Llave Ref.:</b> HE-612</p>
 myonic	 <p>T1 Boost (N/S&gt;700.000)</p> <p><b>Ref.: RM-2259**</b> (Ref. Sirona®: 6547694)</p> <p><b>148'00€</b></p>	<p><b>Tapa Ref.:</b> TT-0836</p>
 myonic	 <p>T2 Boost (N/S&gt;600.000) T3 Boost (N/S&gt;600.000)</p> <p><b>Ref.: RM-2264**</b> (Ref. Sirona®: 6432616)</p> <p><b>148'00€</b></p>	<p><b>Tapa Ref.:</b> TT-0814 <b>Llave Ref.:</b> HE-612</p>
 myonic	 <p>T2 Boost (N/S&gt;700.000) T3 Boost (N/S&gt;700.000) <b>(Confirmar con imagen)</b></p> <p><b>Ref.: RM-2266**</b> (Ref. Sirona®: 6548122)</p> <p><b>148'00€</b></p>	<p><b>Tapa Ref.:</b> TT-0836 <b>Llave Ref.:</b> HE-612</p>
 myonic	 <p>Imagen no disponible</p> <p>T1 Boost (N/S&gt;800.000)</p> <p><b>Ref.: RM-2267**</b> (Ref. Sirona®: 6710409)</p> <p><b>148'00€</b></p>	<p><b>Tapa Ref.:</b> TT-5712 <b>Llave Ref.:</b> HE-617</p>
 myonic	 <p>T2 Boost (N/S&gt;800.000) T3 Boost (N/S&gt;800.000)</p> <p><b>Ref.: RM-2254**</b> (Ref. Sirona®: 6710433)</p> <p><b>148'00€</b></p>	<p><b>Tapa Ref.:</b> TT-5712 <b>Llave Ref.:</b> HE-617</p>

**GARANTÍA** de 12 meses sobre la pinza

**SI NO ENCUENTRAS EL REPUESTO QUE BUSCAS, ¡CONSÚLTANOS!**

**Precios:** impuestos, portes y mano de obra no incluidos.

Rotores compatibles turbinas W&H®









\*Las letras a continuación indican el **tipo de conexión** y **NO influyen** en el modelo de rotor en los casos indicados:

BC o C BC: Borden 3  
N o C N: NSK® MACH

RM o C RM: Midwest 4  
B o C B: Bien Air® (Unifix)

S o C S: Sirona® (Click&Go)  
M o C M: KaVo® (Multiflex)















NQ o C NQ: NSK® QD-J  
\_ o C: W&H® (Roto Quick)

	Modelos para W&H®			Relacionados
 myonic	Top Air 195 Top Air 198 Top Air 398	Top Air 698 Top Air 795 Top Air 797	Top Air 798 Top Air 895 Top Air 898	Tapa Ref.: TT-4165 Llave Ref.: HE-606
	Ref.: <b>RM-2336</b> (Ref. W&H®: 02760000)			148'00€
 myonic	Top Air 196 Top Air 796 Top Air 896			
	Ref.: <b>RM-2345</b> (Ref. W&H®: 02765500)			148'00€
 myonic	Trend TC-80 Trend TC-95 B Trend TC-95 RM			Tapa Ref.: TT-4165 Llave Ref.: HE-606
	Ref.: <b>RM-2356</b> (Ref. W&H®: 03305000)			148'00€
 myonic	Synea® TA-98* sin luz (tapa 2 muescas) Synea® TA-98L Synea® TA-98LC*	Alegra® TE-95 (2003-2008)		Tapa Ref.: TT-4168
	Ref.: <b>RM-2366</b> (Ref. W&H®: 04396600)			148'00€
 myonic	Synea® TA-96*			Tapa Ref.: TT-0096
	Ref.: <b>RM-2346</b> (Ref. W&H®: 04396700)			148'00€
 myonic	Top Air 290B Top Air 295 Top Air 390	Top Air 393 Top Air 395 Top Air 695		
	Ref.: <b>RM-2347</b> (Ref. W&H®: 04396700)			148'00€
 myonic	Alegra® TE-95* (2009-2013) Alegra® TE-98* Alegra® TE-98 C LED			Tapa Ref.: TT-9800 Llave Ref.: HE-606
	Ref.: <b>RM-2386</b> (Ref. W&H®: 04457300 / 05958900 / 05959000 / 0446300)			148'00€
 myonic	Synea® TA-98C LED* (tapa 2 y 3 muescas) Synea® TA-98* sin luz (tapa 3 muescas)			Tapa Ref.: TT-4166 Llave Doble Ref.: HE-602
	Ref.: <b>RM-2316</b> (Ref. W&H®: 05307000 / 05306900)			148'00€
 myonic	Synea® TA-97* Synea® TA-97C LED* Alegra® TE-97*	Alegra® TE-97 C LED* (2009-2013)		Tapa Ref.: TT-3300 Llave Doble Ref.: HE-602
	Ref.: <b>RM-2326</b> (Ref. W&H®: 05307200 / 05959100 / 05959200)			148'00€

GARANTÍA de 12 meses sobre la pinza

SI NO ENCUENTRAS EL REPUESTO QUE BUSCAS, ¡CONSÚLTANOS!



Precios: impuestos, portes y mano de obra no incluidos.

Modelos para W&H®		Relacionados
 myonic	 Synea® Fusion TG-97 Synea® Vision TK-97 <b>Ref.: RM-2317</b> (Ref. W&H: 07006000)	<b>148'00€</b>
 myonic	 Synea® Fusion TG-98 Synea® Vision TK-98 <b>Ref.: RM-2318</b> (Ref. W&H: 07005900)	<b>148'00€</b> <b>Tapa Ref. TG-98:</b> TT-4166 <b>Tapa Ref. TK-98:</b> TT-653 <b>Llave Ref.:</b> HE-602
 myonic	 <b>Ø aspa:</b> 9,78mm Alegra® HS2014 TE-95* (2014-actual) TE-98 LQ (Confirmar con imagen) <b>Ref.: RM-2388</b>	<b>148'00€</b> <b>Tapa Ref.:</b> TT-0656 <b>Llave Ref.:</b> HE-829
 myonic	 <b>Ø aspa:</b> 8,66mm Alegra® HS2014 TE-97* (2014-actual) TE-97 LQ (Confirmar con imagen) <b>Ref.: RM-2389**</b>	<b>158'00€</b> <b>Tapa Ref.:</b> TT-0657 <b>Llave Doble Ref.:</b> HE-610, HE-829
 myonic	 <b>Ø aspa:</b> 9,76mm Alegra® HS2014 TE-98* (2014-actual) (Confirmar con imagen) <b>Ref.: RM-2390</b> (Ref. W&H: 06787501)	<b>158'00€</b> <b>Tapa Ref.:</b> TT-0656 <b>Llave Ref.:</b> HE-829
 myonic	 RC-95BC RC-95BM <b>Ref.: RM-2385**</b>	<b>148'00€</b>
 myonic	 Synea® Vision TK-100 <b>Ref.: RM-2320</b>	<b>158'00€</b> <b>Tapa Ref.:</b> TT-0654 <b>Llave Ref.:</b> HE-619











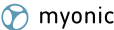

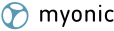

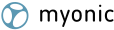

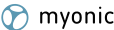

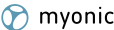

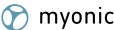
## Rotores compatibles turbinas NSK®

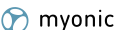
# RUMAR

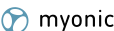







\*Las letras "K", "S", "W" y "B" indican el sistema de acople de la turbina y **NO influyen** en el modelo del rotor.

Modelos para NSK®		Relacionados
 myonic	 CH-QD M NL-65 M <b>Ref.: RM-0001</b> (Ref. NSK: NCH-MU03)	<b>148'00€</b>



Modelos para NSK®			Relacionados
	 <p>CH-QD S NL-65 S Ti-MAX A450*</p>	Ti-MAX A450*L	Llave Doble Ref.: HE-600
	<b>Ref.: RM-0002</b> (Ref. NSK: NCH-SU03)		<b>148'00€</b>
	 <p>CH-QD T NL-65 T Ti-MAX A455*</p>	Ti-MAX A455*L	
	<b>Ref.: RM-0003</b> (Ref. NSK: NCH-TU03)		<b>148'00€</b>
	 <p>Ti-MAX A200* Ti-MAX A200*L Mach-Lite XT M</p>		
	<b>Ref.: RM-0004</b> (Ref. NSK: NMC-MU03)		<b>148'00€</b>
	 <p>Ti-MAX A500* Ti-MAX A500*L Ti-MAX NL95M*</p>		Llave Ref.: HE-107
	<b>Ref.: RM-0007</b> (Ref. NSK: Ti-MU03)		<b>148'00€</b>
	 <p>Ti-MAX A600* Ti-MAX A600*L Ti-MAX NL95S*</p>	Ti-MAX NL45S Ti-MAX A300* Ti-MAX A300*L	Mach-Lite XTS Mach-Lite 2S
	<b>Ref.: RM-0008</b> (Ref. NSK: Ti-SU03, NMC-SU03)		Llave Doble Ref.: HE-600
			<b>148'00€</b>
	 <p>Ti-MAX A700* Ti-MAX A700*L Ti-MAX NL95T*</p>	Ti-MAX NL45T Ti-MAX A400* Ti-MAX A400*L	Mach-Lite XTT Mach-Lite 2T
	<b>Ref.: RM-0009</b> (Ref. NSK: Ti-TU03, NMC-TU03)		Tapa Ref.: TT-0230 Llave Doble Ref.: HE-600
			<b>148'00€</b>
	 <p>Ti-MAX X500* Ti-MAX X500*L NL9000M*</p>		Tapa Ref.: TT-0223 Llave Doble Ref.: HE-605
	<b>Ref.: RM-0010</b> (Ref. NSK: TiX-MU03)		<b>148'00€</b>
	 <p>Ti-MAX X600* Ti-MAX X600*L NL9000S*</p>	Ti-MAX X650* Ti-MAX X650*L	Tapa Ref.: TT-0224 Llave Doble Ref.: HE-600
	<b>Ref.: RM-0011</b> (Ref. NSK: TiX- SU03)		<b>148'00€</b>
	 <p>Ti-MAX X700* Ti-MAX X700*L NL9000*L</p>		Tapa Ref.: TT-0225 Llave Doble Ref.: HE-605
	<b>Ref.: RM-0012</b> (Ref. NSK: TiX-TU03)		<b>148'00€</b>
	 <p>Pana Air Σ T</p>		
	<b>Ref.: RM-0013</b> (Ref. NSK: NPA-TU03)		<b>128'00€</b>

**GARANTÍA** de 12 meses sobre la pinza  
**SI NO ENCUENTRAS EL REPUESTO QUE BUSCAS, ¡CONSÚLTANOS!**  
**Precios:** impuestos, portes y mano de obra no incluidos.

Modelos para NSK®		Relacionados
 myonic	<p>S-Max M500* S-Max M500*L Pana-Max Plus M</p> <p>S-Max M800* S-Max M800*L</p> <p><b>Ref.: RM-0014</b> (Ref. NSK: SX-MU03)</p> <p><b>148'00€</b></p>	Tapa Ref.: TT-0226
 myonic	<p>Ti-MAX Z800* Ti-MAX Z800*L</p> <p><b>Ref.: RM-0018**</b></p> <p><b>158'00€</b></p>	Tapa Ref.: TT-8905 Llave Doble Ref.: HE-614
 myonic	<p>Ti-MAX Z900* Ti-MAX Z900*L</p> <p><b>Ref.: RM-0015**</b></p> <p><b>158'00€</b></p>	Tapa Ref.: TT-8904 Llave Doble Ref.: HE-614
 myonic	<p>S-Max Pico</p> <p><b>Ref.: RM-0016</b></p> <p><b>188'00€</b></p>	Llave Doble Ref.: HE-632
 myonic	<p>Pana-Max T QD T Pana-Max TUM4</p> <p><b>Ref.: RM-0020</b> (Ref. NSK: PAX-TU03)</p> <p><b>148'00€</b></p>	
 myonic	<p>Pana-Max S QD S Pana-Max SUM4</p> <p><b>Ref.: RM-0021</b> (Ref. NSK: PAX-SU03)</p> <p><b>148'00€</b></p>	
 myonic	<p>Pana-Max 2</p> <p><b>Ref.: RM-0022**</b> (Ref. NSK: PAX2-SU03)</p> <p><b>148'00€</b></p>	Tapa Ref.: TT-0232 Llave Doble Ref.: HE-600
 myonic	<p>Pana Air Σ S ECO TOPtorque</p> <p><b>Ref.: RM-0023</b> (Ref. NSK: NPA-SU03)</p> <p><b>118'00€</b></p>	
 myonic	<p>S-Max M600* S-Max M600*L S-Max M900*</p> <p>S-Max M900*L Pana-Max Plus S PAP-SUM4</p> <p><b>Ref.: RM-0028</b> (Ref. NSK: SX-SU03)</p> <p><b>148'00€</b></p>	Tapa Ref.: TT-0227 Llave Doble Ref.: HE-632

GARANTÍA de 12 meses sobre la pinza

SI NO ENCUENTRAS EL REPUESTO QUE BUSCAS, ¡CONSÚLTANOS!

Precios: impuestos, portes y mano de obra no incluidos.



Rotores compatibles turbinas **Castellini®**, **Anthos®**

RUMAR

Modelos para Castellini® / Anthos®		Relacionados
 myonic	<p>Hi Power M Cleanlight Cleanair</p> <p><b>Ref.: RM-2506</b> (Ref. Castellini: L0000874)</p>	<p><b>Tapa Ref.:</b> TT-0801 <b>Llave Ref.:</b> HE-800</p> <p><b>148'00€</b></p>
 myonic	<p>Titanium Gold 2 Hi Power Light Gold</p> <p>Hi Power 2 Hi Power Ceramic</p> <p><b>Ref.: RM-2516</b> (Ref. Castellini®: L0001370)</p>	<p><b>Tapa Ref.:</b> TT-0811 <b>Llave Ref.:</b> HE-810</p> <p><b>148'00€</b></p>
 myonic	<p>Silent Power <b>Gold</b> Silent Power <b>Gold</b> M Silent Power <b>Silver</b> 2</p> <p>Silent Power <b>Silver</b> 2L Silent Power <b>Silver</b> 4L Silent Power <b>Silver</b> 4LK</p> <p><b>Ref.: RM-2528</b> (Ref. Castellini®: L0001857)</p>	<p><b>Tapa Ref.:</b> TT-0827 <b>Llave Ref.:</b> HE-824</p> <p><b>148'00€</b></p>
 myonic	<p>Silent Power <b>EVO</b> 2 Silent Power <b>EVO</b> 2L Silent Power <b>EVO</b> 4L</p> <p>Silent Power <b>EVO</b> 4LK</p> <p><b>Ref.: RM-2518</b></p>	<p><b>Tapa Ref.:</b> TT-0825 <b>Llave Ref.:</b> HE-822</p> <p><b>148'00€</b></p>



Rotores compatibles turbinas **FONA®**

RUMAR

Modelos para FONA®		Relacionados
 myonic	<p>6080MR (Standard) 8060SR (Standard)</p> <p><b>Ref.: RM-2256</b></p>	<p><b>Tapa Ref.:</b> TT-8897</p> <p><b>148'00€</b></p>
 myonic	<p>6080MM (Mini) 8080SM (Mini)</p> <p><b>Ref.: RM-2261</b></p>	<p><b>148'00€</b></p>
 myonic	<p>8080SR (Standard)</p> <p><b>Ref.: RM-2262</b></p>	<p><b>148'00€</b></p>

Rotores compatibles turbinas **LADES®**

RUMAR

Modelo para LADES®		Relacionados
 myonic	<p> Imagen no disponible</p> <p>757* 757 Prostyle* con Multi spray con rods. myonic</p> <p><b>Ref.: RM-2536</b></p>	<p>*Confirmar con imagen</p> <p>Las turbinas con un solo orificio de spray llevan otro rotor.</p> <p><b>148'00€</b></p>

**GARANTÍA** de 12 meses sobre la pinza









**SI NO ENCUENTRAS EL REPUESTO QUE BUSCAS, ¡CONSÚLTANOS!**

**Precios:** impuestos, portes y mano de obra no incluidos.

RUMAR





Rotores compatibles turbinas **B.A. International®**

RUMAR

	Modelos para B.A. International®	Relacionados
 myonic	 <p>B.A. Ultimate 670 B.A. Ultimate 650</p> <p>Ref.: <b>RM-2106</b></p>	<b>148'00€</b>
 myonic	 <p>B.A. Ultimate 535 B.A. Ultimate 685</p> <p>B.A. Ultimate 695 (Confirmar con imagen)</p> <p>Ref.: <b>RM-2256</b></p>	<b>148'00€</b>
 myonic	 <p>B.A. Ultimate 755</p> <p>Ref.: <b>RM-2262</b></p>	<b>148'00€</b>
 myonic	 <p>B.A. Ultimate 695 (Confirmar con imagen)</p> <p>Ref.: <b>RM-2266**</b></p>	<b>148'00€</b>



Rotores compatibles turbinas **FARO®**

RUMAR

	Modelos para FARO®	Relacionados
 myonic	 <p>MT02 Standard MT02L Standard</p> <p>Ref.: <b>RM-2176</b></p>	<p>Tapa Ref.: TT-2076 Llave Doble Ref.: HE-604</p>
 myonic	 <p>MT02 Mini MT02L Mini</p> <p>Ref.: <b>RM-2115</b></p>	<p>Tapa Ref.: TT-7051 Llave Doble Ref.: HE-604</p>

Rotores compatibles turbinas **CHIRANA®**



RUMAR

	Modelos para CHIRANA®	Relacionados
 myonic	 <p>TG 656 TGL 637A (smile - music)</p> <p>Ref.: <b>RM-2106</b></p>	<p>Tapa Ref.: TT-4041 Llave Ref.: HE-609</p>

**Rotores compatibles turbinas R-Tech®**



- Rodamientos cerámicos.
- Con anillos tóricos, arandelas metálicas y anillos de teflón según modelo.
- **Garantía:** 6 meses sobre la pinza

Modelos para R-Tech®		Relacionados
 <p>PowerMax</p> <p><b>Ref.: RM-0401</b></p> <p><b>98'00€</b></p>	<p>Tapa Ref.: TT-0415</p> <p><b>HASTA AGOTAR</b></p>	
 <p>ECO T2 ECO T3 LED PRO T1 L</p> <p><b>Ref.: RM-0250R</b></p> <p><b>64'80€</b></p>	<p>Tapa Ref.: TT-0250T Llave Ref.: HE-252K</p>	
 <p>ECO T TURBO COXO TITAN</p> <p><b>Ref.: RM-0253R</b></p> <p><b>78'00€</b></p>	<p>Tapa Ref.: TT-0253T Llave Ref.: HE-253K</p>	

## ROTORES TURBINAS LABORATORIO

**Rotores compatibles turbinas laboratorio Bien Air®**





Modelos para Bien Air®		Relacionados
 <p>Serie TD (Todos los modelos)</p> <p><b>Ref.: RM-2496</b></p> <p><b>198'00€</b></p>		

 myonic

**Rotores compatibles turbinas laboratorio NSK®**



Modelos para NSK®		Relacionados
 <p>Presto</p> <p><b>Ref.: RM-0080</b> (Ref. NSK: T815-016)</p> <p><b>188'00€</b></p>		
 <p>Presto AQUA (Excepto LUX)</p> <p><b>Ref.: RM-0081</b> (Ref. NSK: T816-016)</p> <p><b>188'00€</b></p>		

 myonic

**GARANTÍA** de 12 meses sobre la pinza

**SI NO ENCUENTRAS EL REPUESTO QUE BUSCAS, ¡CONSÚLTANOS!**

**Precios:** impuestos, portes y mano de obra no incluidos.



Rotores turbinas **MK-dent**<sup>®</sup> (CON INSERTOS DE CARBURO)

	Modelos			Relacionados
	HB11* HB12* HB21K*	HC2021 desde serie F HC4021 (comprobar imagen) HC6021 hasta serie E HC2002	HE11* HE12* HE15L*	*Tapa Ref.: TT-BC1034 Llave Ref.: HE-620, HE-1650T
	<b>Ref.:</b> TR-TC2021		<b>189'00,€</b>	
	HC4011 HC4021 (comprobar imagen) HC6021 desde serie F	HC7031 HC7021 HC5031	HC5021 HC2022	Según modelo: Tapa Ref.: TT-BC2021K Tapa Ref.: TT-BC2031 Llave Ref.: HE-620
	<b>Ref.:</b> TR-TC2031		<b>189'00,€</b>	
	HB14* HB23* HE14*	HC4012 HC6012 HC5022	HC4022 HC7022 HC6022 desde serie F	*Tapa Ref.: TT-BC1035 Llave Ref.: HE-620, HE-1650T
	<b>Ref.:</b> TR-TC2032		<b>189'00,€</b>	
	HE17 (HE010000 < N/S < HE023799) HE21K HE21KL HE21N	HE21NL HE21S HE21SL HE21W	HE21WL HB21	Tapa Ref.: TT-BC1034 Llave Ref.: HE-620, HE-1650T
	<b>Ref.:</b> TR-TC2034		<b>189'00,€</b>	
	HE14 HE18 HE22K HE22KL	HE22N HE22NL HE22S	HE22SL HE22W HE22WL	Tapa Ref.: TT-BC1035 Llave Ref.: HE-620
	<b>Ref.:</b> TR-TC2035		<b>189'00,€</b>	
	HC20K HC20KL HE20k HE20kl	HC21K HC21KL HC21N HC21NL	HC21S HC21SL HC21W HC21WL	
	<b>Ref.:</b> TR-TC2038		<b>189'00,€</b>	
	HC22K HC22KL HC22N	HC22NL HC22S HC22SL	HC22W HC22WL	
	<b>Ref.:</b> TR-TC2039		<b>189'00,€</b>	
	HC8021 HC9021 HP21K HP21KL	HP21S HP21SL HP21N	HP21NL HP21W HP21WL	Tapa Ref.: TT-BC1051 Llave Ref.: HE-1651T
	<b>Ref.:</b> TR-TC2041		<b>189'00,€</b>	
	HC8022 HC9022 HP22K HP22KL	HP22S HP22SL HP22N	HP22NL HP22W HP22WL	Tapa Ref.: TT-BC1042 Llave Ref.: HE-620
	<b>Ref.:</b> TR-TC2042		<b>189'00,€</b>	
	HE17 (N/S > HE023800)			Tapa Ref.: TT-BC1046 Llave Ref.: HE-1651T
	<b>Ref.:</b> TR-TC2046		<b>189'00,€</b>	

NUEVO











Imagen no disponible

# TAPAS TURBINA

Tapas compatibles turbinas **KaVo®**

RUMAR

	Modelos para KaVo®	Relacionados
	SMARTtorque® S605 SMARTtorque® S615C EXPERTtorque® E677  <b>Ref.: TT-7051</b> (Ref. KaVo®: 1.007.7051)	Llave Doble Ref.: HE-604  28'00€
	624                      625D                      630A 625                      627 625C                    630  <b>Ref.: TT-4041</b> (Ref. KaVo®: 0.553.4041)	Llave Ref.: HE-609  54'80€
	MIRAlux® 635 MIRAtorque mini® 637  <b>Ref.: TT-8491</b> (Ref. KaVo®: 0.553.8491)	Llave Ref.: HE-1637T  28'00€
	SUPERtorque® 647                      POWERtorque® 646 SUPERtorque® 650 COMPACTtorque® 636  <b>Ref.: TT-8061</b> (Ref. KaVo®: 0.553.8061)	Llave Doble Ref.: HE-604  28'00€
	CONTACTair® 632                      BELLAtorque® 639 CONTACTair® 633                      BELLAtorque® 642  <b>Ref.: TT-5081</b> (Ref. KaVo®: 0.553.5081)	Llave Ref.: HE-609  28'00€
 <small>Imagen no disponible</small>	BELLAtorque® 645  <b>Ref.: TT-7391</b> (Ref. KaVo®: 0.553.7391)	Llave Ref.: HE-609  28'00€
	SUPERtorque® 640  <b>Ref.: TT-6511</b> (Ref. KaVo®: 0.553.6511)	Llave Ref.: HE-609  28'00€
	SMARTtorque® S609                      GENTLEforce® 6000 SMARTtorque® S619                      GENTLEforce® 7000 SUPERtorque® 655 SUPERtorque® 660  <b>Ref.: TT-2076</b> (Ref. KaVo®: 1.000.2076 / 1.000.4770)	Llave Doble Ref.: HE-604  28'00€
 <small>Imagen no disponible</small>	GENTLEsilence mini® 4500B                      GENTLEsilence mini® 5000C GENTLEsilence mini® 4500C GENTLEsilence mini® 5000B  <b>Ref.: TT-1079</b> (Ref. KaVo®: 1.006.1079)	Llave Doble Ref.: HE-604  28'00€

NUEVO





SI NO ENCUENTRAS EL REPUESTO QUE BUSCAS, ¡CONSÚLTANOS!  
 Precios: impuestos, portes y mano de obra no incluidos.

RUMAR

Modelos para KaVo®		Relacionados
	CENTLEsilence® 8000 MASTERtorque® M9000L  <b>Ref.: TT-5525</b> (Ref. KaVo®: 1.003.5525 / 3.000.1874)	Llave Doble Ref.: HE-604  <b>28'00€</b>
	EXPERTtorque® E679L EXPERTtorque® E680L  <b>Ref.: TT-8903</b> (Ref. KaVo®: 1.007.8903)	Llave Doble Ref.: HE-604  <b>28'00€</b>
 <small>Imagen no disponible</small>	MASTERtorque mini® M8900L  <b>Ref.: TT-8900</b>	<b>56'80€</b>  <b>BAJO PEDIDO</b>
 <small>Imagen no disponible</small>	MASTERtorque mini® M8700L  <b>Ref.: TT-8700</b>	<b>56'80€</b>  <b>BAJO PEDIDO</b>

▶ Tapas compatibles turbinas **Bien Air®**



RUMAR

Modelos para Bien Air®		Relacionados
 <b>3 piezas</b>	Bora S36-L Rotamax L (3 piezas)  <b>Ref.: TT-2468</b>	Llave Doble Ref.: HE-802  <b>34'80€</b>
 <b>1 pieza, NO separable</b>	Bora S36-L Rotamax L  <b>Ref.: TT-2469</b>	Llave Doble Ref.: HE-802  <b>54'80€</b>
	Bora 2  <b>Ref.: TT-2999</b> (Ref. Bien Air® 150.2999)	Llave Ref.: HE-618  <b>56'80€</b>
 <b>3 piezas</b>	Croma Black Pearl Boralina  Eolia S25-L  <b>Ref.: TT-2459</b>	Llave Doble Ref.: HE-802  <b>34'80€</b>
	Prestige  <b>Ref.: TT-0651</b>	Llave Ref.: HE-803  <b>54'80€</b>



## Modelos para Bien Air®

## Relacionados







 Imagen no disponible	<p>Ondine</p> <p>Ref.: <b>TT-2467</b></p> <p><b>54<sup>80</sup>€</b></p>	Llave Ref.: HE-803
 Imagen no disponible	<p>Tornado</p> <p>Ref.: <b>TT-1835</b> (Ref. Bien Air® 1501835)</p> <p><b>54<sup>80</sup>€</b></p>	Llave Ref.: HE-831
 Imagen no disponible	<p>Tornado S (cabeza mini)</p> <p>Ref.: <b>TT-1963</b> (Ref. Bien Air® 1501963)</p> <p><b>54<sup>80</sup>€</b></p>	Llave Ref.: HE-846

## Tapas compatibles turbinas Siemens® / Sirona®

RUMAR

## Modelos para Siemens® / Sirona®

## Relacionados





	<p>TM1 4000ML TS1 4000M TS2 4000SL</p> <p>4000S Siemens T1 Control</p> <p>Ref.: <b>TT-4000</b></p> <p><b>56<sup>80</sup>€</b></p>	
	<p>T1 Control (Exterior: Con rebaje) TC3 Control</p> <p>Ref.: <b>TT-7595</b> (Ref. Sirona®: 3327595 / 5828871)</p> <p><b>32<sup>80</sup>€</b></p>	Llave Ref.: HE-592
	<p>T2 Control T1 Control (sin rebaje)</p> <p>Ref.: <b>TT-0884</b> (Ref. Sirona®: 6000884)</p> <p><b>32<sup>80</sup>€</b></p>	Llave Ref.: HE-591
	<p>T3 Racer (N/S&gt;600.000) T4 Racer (N/S&gt;600.000)</p> <p>Ref.: <b>TT-0212</b></p> <p><b>32<sup>80</sup>€</b></p>	Llave Ref.: HE-612
	<p>T2 mini (600.000&lt;N/S&lt;700.000) T3 mini (600.000&lt;N/S&lt;700.000) T2 mini (700.000&lt;N/S&lt;800.000) T3 mini (700.000&lt;N/S&lt;800.000)</p> <p>Ref.: <b>TT-0213</b></p> <p><b>32<sup>80</sup>€</b></p>	Llave Ref.: HE-592
	<p>Racer (todas) Siroboost</p> <p>Ref.: <b>TT-8897</b> (Ref. Sirona®: 58 28 897)</p> <p><b>32<sup>80</sup>€</b></p>	Llave Ref.: HE-591







BAJO PEDIDO

Modelos para Siemens® / Sirona®		Relacionados
	T1 mini T2 mini  T3 mini  <b>Ref.: TT-8575</b> (Ref. Sirona®: 4178575)	Incluye arandela  <b>32'80€</b>
	T1 Boost (N/S>600.000) T2 Boost (N/S>600.000) T3 Boost (N/S>600.000)  <b>Ref.: TT-0814</b>	<b>Llave Ref.: HE-612</b>  <b>32'80€</b>
	T1 Boost (N/S>700.000) T2 Boost (N/S>700.000) T3 Boost (N/S>700.000)  <b>Ref.: TT-0836</b>	<b>56'80€</b>
 <small>Imagen no disponible</small>	T1 Boost (N/S>800.000) T2 Boost (N/S>800.000) T3 Boost (N/S>800.000)  <b>Ref.: TT-5712</b> (Ref. Sirona®: 6725712)	<b>Llave Ref.: HE-617</b>  <b>56'80€</b>

## Tapas compatibles turbinas W&H®

# RUMAR











Modelos para W&H®		Relacionados
	Top Air 398 Top Air 698 Top Air 795 Top Air 798 Top Air 895  Top Air 898 Trend TC 80BC Trend TC-95BC Alegra® TE-98 Alegra® TE-95 (hasta 2009)  <b>Ref.: TT-4165</b> (Ref. W&H®: 04232400)	<b>Llave Ref.: HE-606</b>  <b>32'80€</b>
	Alegra® TE-95 Alegra® TE-98 Alegra® TE-98 C LED (desde 2009)  <b>Ref.: TT-9800</b> (Ref. W&H®: 05489800)	<b>Llave Ref.: HE-606</b>  <b>56'80€</b>
	Alegra® TE-95 Alegra® TE-98 (hasta 2009)  <b>Ref.: TT-9802</b>	<b>56'80€</b>
 <small>Imagen no disponible</small>	Alegra® HS2014 TE-95 Alegra® HS2014 TE-98  <b>Ref.: TT-0656</b>	<b>Llave Ref.: HE-829</b>  <b>56'80€</b>
 <small>Imagen no disponible</small>	Alegra® HS2014 TE-97  <b>Ref.: TT-0657</b>	<b>Llave Ref.: HE-610, HE-829</b>  <b>56'80€</b>

Modelos para W&H®		Relacionados
	<p><b>3 muescas</b></p> <p>Synea® TA-98C LED Synea® TA-98 (desde 2007) Synea® Vision TK-98</p> <p>Fusion TG-98</p> <p><b>Ref.: TT-4166</b> (Ref. W&amp;H®: 06446300)</p>	<p>Llave Doble Ref.: HE-602</p> <p><b>32´80€</b></p>
	<p><b>3 muescas</b></p> <p>Synea® TA-97C LED Synea® TA-97 (desde 2007)</p> <p><b>Ref.: TT-3300</b> (Ref. W&amp;H®: 05183300)</p>	<p>Llave Doble Ref.: HE-602</p> <p><b>56´80€</b></p>
	<p><b>2 muescas</b></p> <p>Synea® TA-98 (hasta 2009)</p> <p><b>Ref.: TT-4168</b> (Ref. W&amp;H®: 03503000)</p>	<p>Llave Ref.: HE-840</p> <p><b>29´80€</b></p>
	<p>Synea® TA-96 (hasta 2009)</p> <p><b>Ref.: TT-0096</b></p>	<p><b>56´80€</b></p> <p>BAJO PEDIDO</p>
	<p>Synea® Vision TK-95</p> <p><b>Ref.: TT-0655</b></p>	<p><b>56´80€</b></p> <p>BAJO PEDIDO</p>
	<p>Synea® Vision TK-98</p> <p><b>Ref.: TT-0653</b></p>	<p><b>56´80€</b></p>

### Tapas compatibles turbinas NSK®

RUMAR

Modelos para NSK®		Relacionados
	<p>Synea® Vision TK-100</p> <p><b>Ref.: TT-0654</b></p>	<p>Llave Doble Ref.: HE-619</p> <p><b>56´80€</b></p>
	<p>TI-MAX X500 TI-MAX X500L</p> <p><b>Ref.: TT-0223</b></p>	<p>Llave Doble Ref.: HE-605</p> <p><b>29´80€</b></p>
	<p>TI-MAX X600 TI-MAX X600L</p> <p><b>Ref.: TT-0224</b></p>	<p>Llave Doble Ref.: HE-600</p> <p><b>29´80€</b></p>

Modelos para NSK®		Relacionados
	TI-MAX X700 TI-MAX X700L  <b>Ref.: TT-0225</b>	Llave Doble Ref.: HE-605  <b>29<sup>80</sup>€</b>
	TI-MAX Z900 TI-MAX Z900L  <b>Ref.: TT-8904</b>	Llave Doble Ref.: HE-614  <b>29<sup>80</sup>€</b>
	TI-MAX Z800 TI-MAX Z800L  <b>Ref.: TT-8905</b>	Llave Doble Ref.: HE-614  <b>29<sup>80</sup>€</b>
	S-MAX M500 S-MAX M500L  <b>Ref.: TT-0226</b>	<b>29<sup>80</sup>€</b>
	S-MAX M600 S-MAX M600L  <b>Ref.: TT-0227</b>	S-MAX M900 S-MAX M900L  Llave Doble Ref.: HE-632  <b>29<sup>80</sup>€</b>
	TI-MAX A300 TI-MAX A300L MACH LITE S  <b>Ref.: TT-0228</b>	MACH LITE XT S MACH QD-S MACH 2 S  Llave Doble Ref.: HE-600  <b>56<sup>80</sup>€</b>
	TI-MAX A600 TI-MAX A600L TI-MAX NL95  <b>Ref.: TT-0229</b>	TI-MAX NL95 S TI-MAX NL45 S  Llave Doble Ref.: HE-600  <b>56<sup>80</sup>€</b>
	TI-MAX A400 TI-MAX A400L MACH LITE XT T  <b>Ref.: TT-0230</b>	MACH QD-T MACH LITE T MACH 2 T  <b>56<sup>80</sup>€</b>
	TI-MAX A700 TI-MAX A700L TI-MAX NL95 T  <b>Ref.: TT-0231</b>	TI-MAX NL45 T  Llave Doble Ref.: HE-600  <b>56<sup>80</sup>€</b>
	Pana-Max 2  <b>Ref.: TT-0232</b>	<b>28<sup>00</sup>€</b>

## Tapas compatibles turbinas TDK®

## Modelos para TDK®





## Relacionados

	<p>Thera</p> <p>Ref.: <b>TT-0421</b></p> <p><b>48'00€</b></p>	
---	---	--

## Tapas compatibles turbinas Castellini®, Anthos®, Stern Weber® y Cefla®

## Modelos para Castellini®, Anthos®, Stern Weber® y Cefla®

## Relacionados

	<p>Hi Power M Clean Air 2000 Clean Air 2000R</p> <p>Titanium Power Cleanlight 2000 Cleanlight 2000R</p> <p>Ref.: <b>TT-0801</b> (Ref. Castellini®: F633F03RO)</p> <p><b>54'80€</b></p>	<p>Llave Ref.: HE-800</p>
	<p>Silent Power Gold Silent Power Gold M</p> <p>Titanium Gold Titanium Gold 2</p> <p>Ref.: <b>TT-0811</b> (Ref. Castellini®: F699F0RO)</p> <p><b>54'80€</b></p>	<p>Llave Ref.: HE-810</p>
	<p>Silent Power EVO 2 Silent Power EVO 2L</p> <p>Silent Power EVO 4L Silent Power EVO 4LK</p> <p>Ref.: <b>TT-0825</b> (Ref. Fabricante: 95529229)</p> <p><b>54'80€</b></p>	<p>Llave Ref.: HE-822</p>
	<p>Silent Power EVO Miniature Silent Power EVO Miniature K</p> <p>Ref.: <b>TT-0826</b> (Ref. Fabricante: 95529231)</p> <p><b>54'80€</b></p>	<p>Llave Ref.: HE-823</p>
	<p>Silent Power Silver 2 Silent Power Silver 2L</p> <p>Silent Power Silver 4L Silent Power Silver 4LK</p> <p>Ref.: <b>TT-0827</b> (Ref. Castellini®: F699F40RD)</p> <p><b>54'80€</b></p>	<p>Llave Ref.: HE-824</p>





▶ Tapas compatibles turbinas **FARO®**

	Modelos para FARO®	Relacionados
	S400 S405  <b>Ref.: TT-2542</b>	54 <sup>80</sup> €

▶ Tapas compatibles turbinas **CHIRANA®**

	Modelos para CHIRANA®	Relacionados
	TG 656 TGL 637A (smile - music)  <b>Ref.: TT-4041</b>	Llave Ref.: HE-609  54 <sup>80</sup> €

▶ Tapas turbinas **RUMAR®**

	Modelos para RUMAR®	Relacionados
	PowerMax  <b>Ref.: TT-0415</b>	48 <sup>00</sup> €  HASTA AGOTAR
	ECO T1 ECO TLED2  <b>Ref.: TT-0368</b>	28 <sup>00</sup> €  HASTA AGOTAR
	ECO TLED1  <b>Ref.: TT-0341T</b>	28 <sup>00</sup> €  HASTA AGOTAR
	ECO T2 ECO T3 LED PRO T1  <b>Ref.: TT-0250T</b>	Llave Ref.: HE-252K  28 <sup>00</sup> €
	ECO TURBO COXO TITAN  <b>Ref.: TT-0253T</b>	Llave Ref.: HE-253K  28 <sup>00</sup> €

## Tapas turbinas MK-dent®



## Modelos para MK-dent®

## Relacionados

	HC4021 HC5021	HC6021 a partir serie F HC7021 HE12		Llave Ref.: HE- 620
	<b>Ref.:</b> TT-BC2021K		<b>39<sup>´</sup>80€</b>	<b>HASTA AGOTAR</b>
4 lados de contacto 	HP21 HC21 HC20	HC8021 HC9021	(antigua TT-BC2041 y 05-BC1041)	Llave Ref.: HE- 1651T (4 lados de contacto)  *Antiguas BC2041 y BC1041 necesitan llave KE1650T* (4 muescas de contacto)
	<b>Ref.:</b> TT-BC1051		<b>45<sup>´</sup>80€</b>	
	HP22 HP22 L			Llave Ref.: HE-620
	<b>Ref.:</b> TT-BC1042		<b>45<sup>´</sup>80€</b>	
	HC8022 HC9022			Llave Ref.: HE-620
	<b>Ref.:</b> TT-BC2042		<b>39<sup>´</sup>80€</b>	<b>HASTA AGOTAR</b>
	HC2012 desde serie F HC4011			Llave Ref.: HE-620
	<b>Ref.:</b> TT-BC2031		<b>39<sup>´</sup>80€</b>	<b>HASTA AGOTAR</b>
4 muescas 	HE22 HE14 HE18	HE17 (HE010000 < N/S < HE023799)		Llave Ref.: HE-620
	<b>Ref.:</b> TT-BC1034		<b>45<sup>´</sup>80€</b>	
	HE22 HE14 HE18			Llave Ref.: HE-620
	<b>Ref.:</b> TT-BC1035		<b>45<sup>´</sup>80€</b>	
4 lados de contacto 	HE17 (N/S > HE023800)			Llave Ref.: HE-1651T
 Imagen no disponible	<b>Ref.:</b> TT-BC1046		<b>45<sup>´</sup>80€</b>	

NUEVO

## TAPAS DE SPRAY TURBINA / DIFUSOR SPRAY

### Tapas de spray / difusor spray compatibles turbinas KaVo®

RUMAR

Modelos para KaVo®		Observaciones
	SUPERtorque® 630 SUPERtorque® 640  <b>Ref.: TX-8752</b> (Ref. KaVo: 0.553.8752)	<b>14'80€</b>
	SUPERtorque® 647  <b>Ref.: TX-0833</b> (Ref. KaVo: 0.553.0833)	<b>16'80€</b>
	SUPERtorque® 650 SUPERtorque® 655 SUPERtorque® 660  <b>Ref.: TX-0573</b> (Ref. KaVo: 0.553.0573)	Incluye: 2 anillos tóricos. (Ref. KaVo 0.200.6175 y 0.200.6176)
 <small>Imagen no disponible</small>	SUPERtorque® 650 SUPERtorque® 655 SUPERtorque® 660 ***Original KaVo***  <b>Ref.: TX-0563</b> (Ref. KaVo: 0.553.0563 / 5)	Incluye: 1 unidad

### Tapas de spray / difusor spray compatibles turbinas Bien Air®

RUMAR

Modelos para Bien Air®		Observaciones
	Bora ***Original Bien Air***  <b>Ref.: TX-1087</b> (Ref. Bien Air®: 131087 / 009.34.42)	<b>64'80€</b>  HASTA AGOTAR

### Tapas de spray / difusor spray compatibles turbinas RUMAR®

RUMAR

Modelos para RUMAR®		Observaciones
	PowerMax  <b>Ref.: TX-0420</b>	Llave Ref.: HE-629  HASTA AGOTAR



▶ Tapas de spray / difusor spray turbinas **MK-dent®**

	Modelos para MK-dent®	Observaciones
	HC4021 HC5021 HC7021  <b>Ref.: TX-8752</b>	HC2022 HC6021 a partir serie G y otras triple spray  <b>14'80€</b>
	HC4022 HC5022 HC6022  <b>Ref.: TX-0833</b>	HC7022  <b>16'80€</b>
	Tobera de spray turbinas líneas: HE HC HP  <b>Ref.: TX-SP0641</b>	<b>48'00€</b>



## TORNILLOS DE TAPA DE SPRAY / DIFUSOR SPRAY

▶ Tornillos de tapa de spray / difusor spray compatibles turbina **KaVo®**

	Modelos para KaVo®	Observaciones
	SUPERtorque® 630 SUPERtorque® 640  <b>Ref.: TX-3322</b> (Ref. KaVo®: 0.553.3322)	Llave Ref.: HE-1022KT  <b>4'00€</b>
	SUPERtorque® 655 SUPERtorque® 660  <b>Ref.: TX-3391</b> (Ref. KaVo®: 1.000.3391)	Llave Ref.: HE-1022KT  <b>5'80€</b>
	SUPERtorque® 650 B SUPERtorque® 650 C  <b>Ref.: TX-0543</b> (Ref. KaVo®: 0.553.0543)	Llave Ref.: HE-621  <b>5'80€</b>

## Tornillos de tapa de spray turbina MK-dent®



RUMAR

	Modelos para MK-dent®	Observaciones
	HC4021 HC5021 HC7021  <b>Ref.: TX-3322</b>	HC2022 HC6021 a partir serie G Otras triple spray  <b>4'00€</b>  Llave Ref.: HE-1022KT
	Líneas HP Líneas HC Líneas HE  <b>Ref.: TX-SP0630</b>	Llave Ref.: HE-1922  <b>7'00€</b>

## OTROS REPUESTOS TURBINA

## Otros repuestos turbina



	Descripción	Observaciones
	Bola universal turbinas para acople KaVo® y Sirona®.  <b>Ref.: TX-0417</b>	Medida: 1,5mm  <b>1'60€</b>
	Muelle circular sistema acople KaVo® Multiflex.  <b>Ref.: TX-0418</b>	<b>13'80€</b>
	Muelle circular sistema acople Sirona® Click & Go.  <b>Ref.: TX-0418S</b>	<b>13'80€</b>

TODOS LOS REPUESTOS TURBINAS MK-dent® CONSULTE PRECIOS Y DESPIECES

## JUNTAS CONEXIÓN TURBINAS, ACOPLAMIENTOS Y MICROMOTORES

### Juntas Conexión Turbinas, Acoplamientos y Micromotores

	Descripción	Observaciones
	<p>Conector micromotor Bien Air® MC3</p> <p><b>Ref.: TX-3008</b></p> <p><b>2'80€</b></p>	8 agujeros
	<p>Conector Midwest Lux</p> <p><b>Ref.: TX-3006</b></p> <p><b>1'80€</b></p>	6 agujeros
	<p>Conector Midwest Lux 5</p> <p><b>Ref.: TX-3005</b></p> <p><b>2'80€</b></p>	5 agujeros <b>HASTA AGOTAR</b>
	<p>Conector Midwest</p> <p><b>Ref.: TX-3004</b></p> <p><b>1'80€</b></p>	4 agujeros
	<p>Conector Borden 3</p> <p><b>Ref.: TX-3003</b></p> <p><b>2'00€</b></p>	3 agujeros
	<p>Conector Borden 2</p> <p><b>Ref.: TX-3002</b></p> <p><b>2'10€</b></p>	2 agujeros







## LEDs Y BOMBILLAS XENON ROTATORIO

### LEDs RUMAR® para Rotatorio

RUMAR

**Durabilidad:** 5.000 horas  
**Temperatura color:** 4.500 - 5.000 °K

**Tensión:** 3,7 V CC/DC



	Descripción	Observaciones
	KaVo acoplamiento / micromotores. <b>Ref.: BX-001</b> (Ref. KaVo®: 1.007.5372)	30'80€
	Sirona® acoplamiento / micromotores / Sirosonic® L. <b>Ref.: BX-002</b>	30'80€
	Bien Air®, micromotores (MC2, MC3, MX y otras). <b>Ref.: BX-003</b>	30'80€
	Bien Air®, turbinas. <b>Ref.: BX-004</b>	30'80€
	NSK® acoplamiento NL / PTL. <b>Ref.: BX-005</b>	30'80€
	NSK® acoplamiento KCL / SCL, micromotor M40 y acoplamiento tipo Multiflex fabricado por NSK®. <b>Ref.: BX-007</b>	30'80€
	R-Tech®, acoplamiento conexión Multiflex. <b>Ref.: BX-341</b>	18'00€ No válido para acoplamiento KaVo.













### LEDs RUMAR® para Rotatorio

RUMAR

**Durabilidad:** 5.000 horas  
**Temperatura color:** 5.500 °K

**Tensión:** 3 - 3,5 V CC/DC  
**Potencia:** 50.000 LUX

	Descripción	Observaciones
	KaVo® / MK-dent®, acoplamiento. <b>Ref.: BX-LEDK</b> (Ref. KaVo®: 1.007.5372)	Incluye: Casquillo AX-SP0490 38'80€
	KaVo®, micromotores. <b>Ref.: BX-LEDKM</b>	38'80€
	Bien Air®, micromotores. <b>Ref.: BX-LEDBA</b>	38'80€









	Descripción	Observaciones
	Bien Air®, turbinas. <b>Ref.: BX-LEDBAK</b>	38'80€
	Sirona®, micromotores. <b>Ref.: BX-LEDSG</b>	38'80€
	Sirona®, acoplamiento, ultrasonidos Sirosonic® L y jeringa SprayvitL (Excepto TSI Siemens®). <b>Ref.: BX-LEDSB</b>	38'80€
	W&H® / ADEC turbinas. <b>Ref.: BX-LEDWH</b>	38'80€
	W&H® Motor LT25. <b>Ref.: BX-LEDWEA</b>	38'80€
	NSK® acoplamiento NL / PTL. <b>Ref.: BX-LEDN</b>	38'80€
	NSK® micromotores NL (M40 NL400 / KCL6). <b>Ref.: BX-LEDNNL</b>	38'80€
	NSK® acoplamiento KCL / SCL, motor M40 y acoplamiento tipo Multiflex fabricado por NSK®. <b>Ref.: BX-LEDNM</b>	38'80€
	NSK® micromotores TIM40 / TI205L. <b>Ref.: BX-LEDNT</b>	38'80€
	Castellini®, Turbinas, 1 pin. <b>Ref.: BX-LEDC</b>	38'80€
	Micromotor MK-dent® EM1190K. <b>Ref.: BX-LEDEM</b>	38'80€
 <small>Imagen no disponible</small>	Micromotor MK-dent® AM1006. <b>Ref.: BX-LEDMI</b>	38'80€

**Bombillas Xenon RUMAR® para Rotatorio**

RUMAR

Durabilidad: 300 horas

Tensión: 2,5 - 3 V CA/AC o CC/DC

	Descripción	Observaciones
	KaVo® / MK-dent® acoplamiento / micromotores.  <b>Ref.: BX-XENONK</b> (Ref. KaVo®: 0.553.3881 / 1.002.2928)	13 <sup>80</sup> €
	Bien Air, micromotores.  <b>Ref.: BX-XENONBA</b> (Ref. Bien Air 211.60.16 / 1500007)	14 <sup>80</sup> €
	Bien Air, turbinas.  <b>Ref.: BX-XENONBAK</b> (Ref. Bien Air 204.33.07 / 1500000)	14 <sup>80</sup> €
	W&H, turbinas.  <b>Ref.: BX-XENONWH</b> (Ref. W&H 02207600)	14 <sup>80</sup> €
	Sirona, acoplamiento.  <b>Ref.: BX-XENONSB</b> (Ref. Sirona 5940291)	14 <sup>80</sup> €
	Sirona, micromotores.  <b>Ref.: BX-XENONSG</b> (Ref. Sirona 5945407)	14 <sup>80</sup> €
	NSK, acoplamiento NL / PTL.  <b>Ref.: BX-XENONN</b> (Ref. NSK Y4900529)	14 <sup>80</sup> €
	NSK, micromotores NL (M40 NL400) y acoplamiento KCL6  <b>Ref.: BX-XENONNL</b>	14 <sup>80</sup> €

# ARANDELAS Y ANILLOS TÓRICOS TURBINAS

## Arandelas Turbinas

RUMAR

	Descripción	Observaciones
	Arandela <b>metálica</b> para turbinas KaVo® 655, 660, 7000, 6000 trasera y compatibles. <b>***Original KaVo***</b> <b>Ref.: TX-5032</b> (Ref. KaVo®: 1.001.5032)	Medidas: 4,9x6,35mm 1'80€
	Arandela <b>metálica</b> para turbinas KaVo® 8000, 9000 y delantero E680L y compatibles. <b>***Original KaVo***</b> <b>Ref.: TX-5900</b> (Ref. KaVo®: 1.003.5900)	1'80€
	Arandela <b>metálica</b> para turbinas KaVo® E680L trasera, S609, S619L y compatibles. <b>***Original KaVo***</b> <b>Ref.: TX-7576</b> (Ref. KaVo®: 1.003.7576)	Medidas: 4,7x6,0x0,1mm 1'80€
	Arandela <b>metálica</b> para turbinas KaVo® 5000, 6000 delantera y compatibles. <b>***Original KaVo***</b> <b>Ref.: TX-6391</b> (Ref. KaVo®: 1.001.6391)	Medidas: 4,7x6,0 mm 1'80€
	Arandela <b>metálica</b> para turbinas W&H®. (Excepto HS2014) <b>***Original W&amp;H***</b> <b>Ref.: TX-9408</b> (Ref. W&H®: 02749408)	1'80€
	Arandela <b>metálica</b> para turbinas Alegria® HS2014 TE-95, Alegria® HS2014 TE-97 y Alegria® HS2014 TE-98 <b>Ref.: TX-2495</b>	1'80€
	Arandela <b>metálica</b> para turbinas Bien Air® Bora, Black Pearl y compatibles. <b>Ref.: TX-2490</b>	NO Black Pearl ECO 1'30€
	Anillo de <b>Teflón</b> ancho turbinas Bien Air®. <b>***Original Bien Air***</b> <b>Ref.: TX-3452</b> (Ref. Bien Air®: 009.34.52)	Medidas: 3,25x7,9mm 2'20€
	Anillo de <b>Teflón</b> fino turbinas Bien Air. <b>***Original Bien Air***</b> <b>Ref.: TX-3456</b> (Ref. Bien Air®: 009.34.56)	Medidas: 5,1x7,9mm 1'60€

## Anillos tóricos rotores turbinas





RUMAR

	Descripción	Observaciones
	Rotores turbinas KaVo® todos los modelos MK-dent todos los modelos. <b>Ref.: OR-6172</b> (Ref. KaVo®: 0.200.6172 / MK-dent®: OR1011K)	1'80€
	Rotores turbinas Sirona® T1, Siroboost y compatibles. <b>Ref.: OR-8988</b> (Ref. Sirona®: 70 28 988 / 63 73 747)	Medidas: 1X6mm 1'80€
	Rotores turbinas Sirona® T2 Racer y compatibles <b>***Original Sirona***</b> <b>Ref.: OR-9416</b> (Ref. Sirona®: 5829416)	1'90€

	Descripción	Observaciones
 <small>Imagen no disponible</small>	Rotores turbinas Bien Air®. (Excepto Prestige)  <b>Ref.: OR-0181</b> (Ref. Bien Air®: 705.01.81)	1'00.€
	Rotores turbinas Bien Air® Prestige grande. <b>***Original Bien Air***</b>  <b>Ref.: OR-0235</b> (Ref. Bien Air®: 705.02.35)	5'20.€ <span style="float: right; background-color: yellow;">HASTA AGOTAR</span>
	Rotores turbinas Bien Air® Prestige pequeño. <b>***Original Bien Air***</b>  <b>Ref.: OR-0239</b> (Ref. Bien Air®: 705.02.39)	3'60.€ <span style="float: right; background-color: yellow;">HASTA AGOTAR</span>
	Rotores turbinas NSK® X500 / 600 / 700.  <b>Ref.: OR-0158</b>	1'00.€
	Rotores turbinas W&H®.  <b>Ref.: OR-6001</b> (Ref. W&H®: 01066001)	1'00.€
 <small>Imagen no disponible</small>	Rotores turbinas W&H® HS2014 TE-95, HS2014 TE-97 y HS2014 TE-98  <b>Ref.: OR-0141</b>	1'80.€ <span style="float: right; background-color: yellow;">HASTA AGOTAR</span>

## Otros Anillos Tóricos Turbinas

RUMAR

	Descripción	Observaciones
	Unión cuerpo KaVo® / MK-dent®.  <b>Ref.: OR-0414</b>	1'40.€
	Tubo agua, KaVo®.  <b>Ref.: OR-0415</b>	1'40.€
	Tubo aire KaVo® / MK-dent®.  <b>Ref.: OR-0416</b>	1'50.€
	Conector interno KaVo® / MK-dent®.  <b>Ref.: OR-0419</b>	1'50.€
	Tapa Spray KaVo® 630 / 640 y 645. MK-dent® todos los modelos excepto Prime Line.  <b>Ref.: OR-6132</b> (Ref. KaVo®: 0.200.6132)	1'50.€









	Descripción	Observaciones
	Tapa Spray KaVo® 647 / 650 / 655 / 6000 / 7000 y 8000. ***Original KaVo*** Ref.: <b>OR-6175</b>	Medidas: 5,6x0,5mm (Pequeño) 4'90€
	Tapa Spray KaVo® 647 / 650 / 655 / 6000 / 7000 y 8000. ***Original KaVo*** Ref.: <b>OR-6176</b> (Ref. KaVo®: 0.200.6176)	Medidas: 8,5x0,5mm (Grande) 4'50€
	Difusor spray Bien Air® Bora. Ref.: <b>OR-0431</b> (Ref. Bien Air®: 1300431 / 705.02.50)	3'80€
 <small>Imagen no disponible</small>	Anillo tórico pequeño sistema acople NSK®. Ref.: <b>OR-0414NT</b>	1'50€
 <small>Imagen no disponible</small>	Anillo tórico grande sistema acople NSK®. Ref.: <b>OR-0412NT</b>	1'50€
	Kit completo, 5 anillos tóricos NSK®. Ref.: <b>OR-0411</b>	7'80€



## Anillos Tóricos Acoplamientos

RUMAR

BAJADA  
PRECIO



NUEVO

	Descripción	Observaciones
	Kit completo, 5 anillos tóricos Kavo® Multiflex. Ref.: <b>OR-4011</b>	6'80€
	Kit completo, 4 anillos tóricos Sirona® Click & Go. Ref.: <b>OR-4000</b>	No válidos para acoplamientos MK-dent® QC5016SW y QC6016SW. 5'50€
	Anillo tórico acoplamiento MK-dent® QC5016SW y QC6016SW Ref.: <b>OR-4011S</b> (Ref. MK-dent®: OR4011S/10)	No válidos para otros acoplamientos tipo Sirona® Click & Go 1'30€
	Kit completo, 3 anillos tóricos Bien® Air Unifix. Ref.: <b>OR-4001</b>	6'50€
	Kit completo, 3 anillos tóricos W&H® Roto-Quick. Ref.: <b>OR-4012</b>	4'80€
	Kit completo, 4 anillos tóricos rm TopFlex y NSK® PanaAir. Ref.: <b>OR-4307</b>	4'80€
 <small>Imagen no disponible</small>	Anillo tórico pequeño sistema acople NSK®. Ref.: <b>OR-0414NT</b>	1'50€

	Descripción	Observaciones
 <small>Imagen no disponible</small>	Anillo tórico grande sistema acople NSK®. <b>Ref.: OR-0412NT</b>	<b>1'50€</b>
	Kit completo, 5 anillos tóricos NSK®. <b>Ref.: OR-0411</b>	<b>7'50€</b>







▶ Anillos tóricos scalers y ultrasonidos

RUMAR

	Descripción	Observaciones
 <small>Imagen no disponible</small>	Kit completo, 7 anillos tóricos scaler ECO S2. <b>Ref.: OR-ECOS2OR</b>	<b>9'80€</b>
	Anillo tórico conexión piezas de mano Woodpecker® y DTE®. <b>Ref.: 28-U011</b>	Pack 6 uds. <b>3'80€</b>
	Anillo tórico piezas de mano Woodpecker® y DTE®. <b>Ref.: 28-U012</b>	Pack 3 uds. <b>2'80€</b>

▶ Respuestos acoplamientos

RUMAR

	Descripción	Observaciones
 <small>Imagen no disponible</small>	Protector bombilla acoplamiento QC5016K y QC5016KW. <b>Ref.: AX-SP0460</b>	<b>Válida</b> para Xenón BX-XENONK <b>15'80€</b>
	Protector bombilla acoplamiento QC6016K y QC6016KW. <b>Ref.: AX-SP0490</b>	<b>Válida</b> para LED BX-LEDK <b>15'80€</b>
 <small>Imagen no disponible</small>	Protector bombilla acoplamiento QC5016SW. <b>Ref.: AX-SP0460S</b>	<b>Válida</b> para Xenón BX-XENONSG <b>15'80€</b>
 <small>Imagen no disponible</small>	Protector bombilla acoplamiento QC6016SW. <b>Ref.: AX-SP0491</b>	<b>Válida</b> para LED BX-LEDSB <b>15'80€</b>
 <small>Imagen no disponible</small>	Tubito entrada de aire acoplamiento Kavo® / MK-dent®. <b>Ref.: AX-SP0461</b>	<b>3'00€</b> <b>HASTA AGOTAR</b>
 <small>Imagen no disponible</small>	Tubito salida de aire acoplamiento Kavo® / MK-dent®. <b>Ref.: AX-SP0462</b>	<b>3'00€</b> <b>HASTA AGOTAR</b>
 <small>Imagen no disponible</small>	Tubito entrada de agua de spray acoplamiento Kavo® / MK-dent®. <b>Ref.: AX-SP0464</b>	<b>Medidas:</b> 8,5x0,5mm <b>2'50€</b> <b>HASTA AGOTAR</b>

	Descripción	Observaciones
 <small>Imagen no disponible</small>	Tubo de aire de spray acoplamiento Kavo® / MK-dent®.  <b>Ref.: AX-SP0465</b>	1'00.€ <span style="float: right;">HASTA AGOTAR</span>
 <small>Imagen no disponible</small>	Válvula agua spray acoplamiento Kavo® / MK-dent®.  <b>Ref.: AX-SP0466</b>	12'50.€ <span style="float: right;">HASTA AGOTAR</span>
 <small>Imagen no disponible</small>	Anillo acoplamiento Kavo® / MK-dent®.  <b>Ref.: AX-SP0467</b>	3'90.€ <span style="float: right;">HASTA AGOTAR</span>
 <small>Imagen no disponible</small>	Pin acoplamiento Kavo® / MK-dent®.  <b>Ref.: AX-SP0468</b>	1'00.€ <span style="float: right;">HASTA AGOTAR</span>
 <small>Imagen no disponible</small>	Tornillo acoplamiento Kavo® / MK-dent®.  <b>Ref.: AX-SP0481</b>	1'50.€ <span style="float: right;">HASTA AGOTAR</span>

# RODAMIENTOS CERÁMICOS para **TURBINA**

## MÍNIMO ABEC7











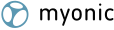

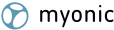

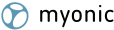

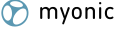
RODAMIENTOS DISEÑADOS PARA EL FUNCIONAMIENTO  
SEGÚN ESPECIFICACIONES DE CADA INSTRUMENTO

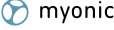

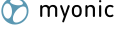

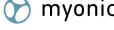
Todos los rodamientos que ofrecemos están fabricados por los principales fabricantes de rodamientos a nivel mundial: myonic®, Barden, GRW, NMB, NHBB o ESI. Todos fabricados de acuerdo a las normas de precisión ISO\* (normas para rodamientos de dimensiones métricas) y ABEC\*\* (rodamientos generalmente en dimensiones de pulgadas).

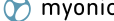
\* ISO: International Standard Organization.

\*\* ABEC: Annular Bearing Engineers Conference.

Modelos para KaVo®			Descripción
	 <p>625 627 630 639</p>	<p>640 632 642 645</p>	<p>636 646 Delantero 637 Trasero 650</p> <p><b>Ref.: ROD-6502</b> (Ref. KaVo®: 0.220.0125)</p> <p><b>23'80€</b></p> <p><b>Medidas:</b> 3,175x6,350x2,778mm Exterior: Con rebaje Bola: Cerámica Contacto: Angular Retenedor: Torlon Cerrado</p>
	 <p>625 627 630 639</p>	<p>640 632 642 645</p>	<p>636 646 Delantero 637 Trasero 650</p> <p><b>Ref.: ROD-222</b> (Ref. KaVo®: 0.220.0125)</p> <p><b>17'80€</b></p> <p><b>Medidas:</b> 3,175x6,350x2,778mm Exterior: Con rebaje Bola: Cerámica Contacto: Radial Retenedor: Torlon Cerrado</p>
	 <p>Trasero 637 Delantero 6000</p>		<p>636 646 Delantero 637 Trasero 650</p> <p><b>Ref.: ROD-352</b> (Ref. KaVo®: 0.220.2015)</p> <p><b>28'80€</b></p> <p><b>Medidas:</b> 3,175x6,350x2,381/2,778mm Exterior: Con rebaje Bola: Cerámica Contacto: Angular Retenedor: Phenolic Cerrado</p>
	 <p>Delantero 650</p>		<p>636 646 Delantero 637 Trasero 650</p> <p><b>Ref.: ROD-6501</b> (Ref. KaVo®: 0.220.2009)</p> <p><b>39'80€</b></p> <p><b>Medidas:</b> 3,175x6,350x4,178 / 3,230mm Exterior: Con rebaje Bola: Cerámica Contacto: Angular Retenedor: Torlon Cerrado</p>
	 <p>655 660 619</p>	<p>609 Delantero 8000 Delantero E679</p>	<p>Delantero E680 Delantero 6500BR</p> <p><b>Ref.: ROD-225</b> (Ref. KaVo®: 1.000.7980)</p> <p><b>23'80€</b></p> <p><b>Medidas:</b> 3,175x6,350x2,778mm Exterior: Liso Bola: Cerámica Contacto: Angular Retenedor: Torlon Cerrado</p>
	 <p>7000 Trasero 8000 Trasero E675</p>	<p>Trasero E677 S605 S615</p>	<p>Trasero 6500BR Trasero 6500B</p> <p><b>Ref.: ROD-223</b> (Ref. KaVo®: 1.000.7979)</p> <p><b>24'80€</b></p> <p><b>Medidas:</b> 3,175x6,350x2,380 / 2,778mm Exterior: Liso Bola: Cerámica Contacto: Angular Retenedor: Torlon Cerrado</p>
	 <p>5000 Delantero E675 Delantero E677</p>	<p>Trasero E679 Trasero E680 Delantero 6500B</p>	<p><b>Ref.: ROD-224</b> (Ref. KaVo®: 1.007.6975)</p> <p><b>27'80€</b></p> <p><b>Medidas:</b> 3,175x6,439x2,413mm Exterior: Con rebaje Bola: Cerámica Contacto: Angular Retenedor: Torlon Cerrado</p>
	 <p>M9000 M9000L</p>		<p><b>Ref.: ROD-205</b></p> <p><b>26'80€</b></p> <p><b>Medidas:</b> 3,175x6,350x2,778mm Exterior: Liso Bola: Cerámica Contacto: Angular Retenedor: Torlon Integral</p>

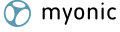

Rodamientos turbinas **Bien Air®**



Modelos para Bien Air®			Descripción
	<p>Bora* *Excepto Bora 2 Black Pearl</p>	<p>Croma S Croma X Boralina Eolia</p>	<p>Rotamax L Tornado X Series TD laboratorio</p>
	<p>Prestige Prestilina Croma M</p>	<p>Ondine Bora 2 (no otros modelos Bora)</p>	
	<b>Ref.: ROD-615</b> (Ref. Bien Air: 701.01.00)		<p><b>Medidas:</b> 3,175x7,938x3,571mm</p> <p>Exterior: Liso Bola: Cerámica Contacto: Angular Retenedor: Torlon Cerrado</p> <p><b>21<sup>80</sup> €</b></p>
	<b>Ref.: ROD-229</b> (Ref. Bien Air: 701.01.09)		<p><b>Medidas:</b> 3,175x6,350x2,778mm</p> <p><b>Especial</b> Exterior: Liso Bola: Cerámica Contacto: Radial Retenedor: Phenolic Cerrado</p> <p><b>20<sup>80</sup> €</b></p>

Rodamientos turbinas **Sirona® y Siemens®**

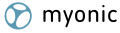
Modelos para Sirona® / Siemens®			Descripción
	<p>Siemens® TS1 Siemens® TS2 T1 (hasta N/S: 50.000)</p>	<p>TS1 TS2</p>	<p><b>Medidas:</b> 3,175x6,350x2,778mm</p> <p>Exterior: Con rebaje Bola: Cerámica Contacto: Radial Retenedor: Torlon Cerrado</p>
	<p>Siemens® TS1 Siemens® TS2 T1 Control (hasta N/S: 50.000)</p>	<p>TS1 TS2</p>	<p><b>Medidas:</b> 3,175x6,350x2,778mm</p> <p>Exterior: Con rebaje Bola: Cerámica Contacto: Angular Retenedor: Torlon Cerrado</p>
	<p>T2 Control T2 Racer T3 Racer</p>	<p>TC3 T1 (N/S&gt;50.000) Siroboost</p>	<p>T2 mini T3 mini</p>
	<p>Siemens® TM1 Siemens® 4000ML Siemens® 4000M</p>	<p>T1 mini</p>	<p><b>Medidas:</b> 3,175x6,350x2,380mm</p> <p>Exterior: Con rebaje Bola: Cerámica Contacto: Radial Retenedor: Torlon Cerrado</p>
	<b>Ref.: ROD-222</b>		<b>17<sup>80</sup> €</b>
	<b>Ref.: ROD-6502</b>		<b>23<sup>80</sup> €</b>
	<b>Ref.: ROD-205</b> (Ref. Sirona: 5994814 (K))		<b>26<sup>80</sup> €</b>
	<b>Ref.: ROD-207</b>		<b>26<sup>80</sup> €</b>

Rodamientos turbinas **W&H®**

Modelos para W&H®			Descripción
	<p>Alegra® TE-95 Alegra® TE-97 Alegra® TE-98 Toda la línea Alegra® (hasta 2013)</p>	<p>Top Air 196 Top Air 796 Top Air 896 Top Air TC-80</p>	<p>Top Air TC-83 Top Air TC-95 Top Air TC-98</p>
	<p>Alegra® HS2014 TE-95 (2014-actual) Alegra® HS2014 TE-97 (2014-actual) Alegra® HS2014 TE-98</p>	<p>RC-95BC RC-95BM</p>	
	<b>Ref.: ROD-206</b> (Ref. W&H: 05958600 y compatibles)		<p><b>Medidas:</b> 3,175x6,350x2,778mm</p> <p>Exterior: Liso Bola: Cerámica Contacto: Radial Retenedor: Torlon Cerrado</p> <p><b>16<sup>80</sup> €</b></p>
	<b>Ref.: ROD-235</b>		<p><b>Medidas:</b> 3,175x6,310/6,350/7,518x2,778mm</p> <p>Exterior: Reborde Bola: Cerámica Contacto: Radial Retenedor: Torlon Cerrado</p> <p><b>23<sup>80</sup> €</b></p>





Modelos para W&H®			Descripción
 myonic	Synea® TA-96 Synea® TA-97 Synea® TA-98 Toda la línea Synea® Trend	TK-97LM TK-98LM TK-100LM TG-97L TG-98L	TA-97LW Top Air 195, 198, 398 Top Air 698, 795, 797 Top Air 798, 895, 898
	<b>Ref.: ROD-205</b> (Ref. W&H: 02770712, 04378600, 05288500 y compatibles)		<b>26'80€</b>
 myonic	395 396 695	696 TK-94L TK-94LM	<b>Medidas:</b> 3,175x6,350x2,380mm Exterior: Liso Bola: Cerámica Contacto: Angular Retenedor: Torlon Integral
	<b>Ref.: ROD-226</b>		<b>27'80€</b>

## Rodamientos turbinas NSK®

RUMAR





\*Las letras "K", "S", "W" y "B" indican el sistema de acople de la turbina y **no influyen** en el modelo del rotor

\*\* En los modelos **X500**, **X600** y **X700**, sólo es posible cambiar los rodamientos en rotores compatibles. A pesar de ser los mismos rodamientos, en los originales los rodamientos están soldados al eje por lo que no es posible cambiarlos.

Modelos para NSK®			Descripción	
 myonic	Aqua Presto Alpha Light	Phatelus	<b>Medidas:</b> 3,175x6,350x7,518x2,778mm Exterior: Con rebaje Bola: Cerámica Contacto: Radial Retenedor: Phenolic Cerrado	
	<b>Ref.: ROD-227</b>		<b>19'80€</b>	
 myonic	Ti-MAX X600/L* Ti-MAX X700/L* Ti-MAX NL9000S/ T/ M	Trasero Ti-MAX X500/L* S-Max M600/L* S-Max M900/L*	<b>Medidas:</b> 3,175x6,350x2,380mm Exterior: Liso Bola: Cerámica Contacto: Angular Retenedor: Torlon Integral	
	<b>Ref.: ROD-226**</b>		<b>27'80€</b>	
 myonic	Delantero X500/L*		<b>Medidas:</b> 3,175x6,350x2,380mm Exterior: Con rebaje Bola: Cerámica Contacto: Radial Retenedor: Torlon Cerrado	
	<b>Ref.: ROD-207</b>		<b>26'80€</b>	
 myonic	Trasero Ti-MAX A400/L* Ti-MAX A300/L* NL65-CH QD-NL45-MACH Trasero Pana Max T Trasero Pana Max QD-T N75-MACH Trasero Pana Max S Trasero Pana Max QD-S Pana Max PAX-TU M4/B2 Pana-Max PAX-SU M4/B2 Mach-Lite S Mach-Lite XT-M Mach-Lite XT-MU Ti-MAX A200/L* NL75 NL85	NL75 Mach-Lite M NL85 Mach-Lite M Mach 2 M/MU Mach QD-M Mach QD-S Mach-Lite XT T/TU Mach 2 T/TU NL65 Mach-Lite S NL75 Mach-Lite S NL85 Mach-Lite S NL65 Mach-Lite T NL75 Mach-Lite T NL85 Mach-Lite T Mach-Lite XT S/SU Mach 2 S/SU Pana Air Σ SU M4/B2 NL65	NL45T Phatelus 45 T/TU Phatelus II T/TU MACH-QD T Ti-MAX A455/L* Phatelus III T/TU Mach-Lite M Phatelus II M/MU NL65M Ti-MAX A600/L* Ti-MAX NL95S Ti-MAX NL45S Ti-MAX A700/L* Ti-MAX NL95T Ti-MAX NL45T	<b>Medidas:</b> 3,175x6,350x2,381mm Exterior: Liso Bola: Cerámica Contacto: Radial Retenedor: Phenolic Cerrado
	<b>Ref.: ROD-228</b>		<b>17'80€</b>	

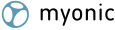

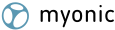
Rodamientos turbinas **Castellini®**, **Anthos®** y **Cefla®**

RUMAR

Modelos para Castellini®, Anthos®, Stern Weber® y Cefla®		Descripción
	 Gold Silent Power  <b>Ref.: ROD-205</b>	<b>Medidas:</b> 3,175x6,350x2,778mm Exterior: Liso Bola: Cerámica Contacto: Angular Retenedor: Torlon Integral  <b>26<sup>80</sup> €</b>
	 Clean Air 2000 High Power M  <b>Ref.: ROD-227</b>	<b>Medidas:</b> 3,175x6,350/7,518x2,778mm Exterior: Con rebaje Bola: Cerámica Contacto: Radial Retenedor: Phenolic Cerrado  <b>19<sup>80</sup> €</b>

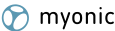

Rodamientos turbinas **FARO®**

RUMAR

Modelos para Faro®		Descripción
	 S404  <b>Ref.: ROD-205</b>	<b>Medidas:</b> 3,175x6,350x2,779 mm Exterior: Liso Bola: Cerámica Contacto: Angular Retenedor: Torlon Integral  <b>26<sup>80</sup> €</b>

Rodamientos turbinas **Lares®**

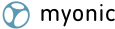
RUMAR

Modelos para Lares®		Descripción
	 557CX 757CX  <b>Ref.: ROD-226</b>	<b>Medidas:</b> 3,175x6,350x2,380mm Exterior: Liso Bola: Cerámica Contacto: Angular Retenedor: Torlon Integral  <b>27<sup>80</sup> €</b>



Rodamientos turbinas **TKD®**

RUMAR

Modelos para TKD®		Descripción
	 Bravia Thera  <b>Ref.: ROD-226</b>	<b>Medidas:</b> 3,175x6,350x2,380mm Exterior: Liso Bola: Cerámica Contacto: Angular Retenedor: Torlon Integral  <b>27<sup>80</sup> €</b>



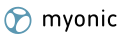

Rodamientos turbinas **KMD®**

Modelos para KMD®		Descripción
	 Mistral M4 DPS  <b>Ref.: ROD-228</b>	<b>Medidas:</b> 3,175x6,350x2,381mm Exterior: Liso Bola: Cerámica Contacto: Radial Retenedor: Phenolic Cerrado  <b>17'80€</b>
	 Solaris  <b>Ref.: ROD-205</b>	<b>Medidas:</b> 3,175x6,350x2,778mm Exterior: Liso Bola: Cerámica Contacto: Angular Retenedor: Torlon Integral  <b>26'80€</b>



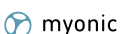





Rodamientos turbinas **R-Tech®**

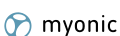

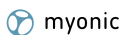
Modelos para R-Tech®		Descripción
	 Powermax  <b>Ref.: ROD-226</b>	<b>Medidas:</b> 3,175x6,350x2,380mm Exterior: Liso Bola: Cerámica Contacto: Angular Retenedor: Torlon Integral  <b>27'80€</b>

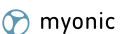
Rodamientos turbinas **MK-dent®**

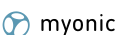









Modelos para MK-dent®				Descripción	
	 Delantero HC9021 Delantero HC8021 Delantero HP21  <b>Ref.: ROD-205</b>	Delantero HP21L Delantero HC20 Delantero HC20L	Delantero HC21 Delantero HC21L	<b>Medidas:</b> 3,175x6,350x2,778mm Exterior: Liso Bola: Cerámica Contacto: Angular Retenedor: Torlon Integral  <b>26'80€</b>	
	 Trasero HC9021 Trasero HC8021 Trasero HP21  <b>Ref.: ROD-223</b>	Trasero HP21L Trasero HC20 Trasero HC20L	Trasero HC21 Trasero HC21L Trasero HE22 Trasero HE22L	<b>Medidas:</b> 3,175x6,350x2,380 / 2,778mm Exterior: Liso Bola: Cerámica Contacto: Angular Retenedor: Torlon Cerrado  <b>24'80€</b>	
	 Delantero HE17 (Todos N/S) Delantero HE21 Delantero HE21L  <b>Ref.: ROD-225</b>			<b>Medidas:</b> 3,175x6,350x2,778mm Exterior: Liso Bola: Cerámica Contacto: Angular Retenedor: Torlon Cerrado  <b>23'80€</b>	
	 HC7032 HC7031 HC7022 HC6022 (según N/S)	HC6012 HC5032 HC5031 HC5021	HC4022 HC4021 HC4012 HC2022	HC2012 Delantero HP21 Delantero HP21L  <b>Ref.: ROD-6502</b>	<b>Medidas:</b> 3,175x6,350x2,778mm Exterior: Con rebaje Bola: Cerámica Contacto: Angular Retenedor: Torlon Cerrado  <b>23'80€</b>
	 HC22 HC22L HP22	HP22L HC8022 HC9022		<b>Medidas:</b> 3,175x6,350x2,381/2,778mm Exterior: Con rebaje Bola: Cerámica Contacto: Angular Retenedor: Phenolic Cerrado  <b>Ref.: ROD-352</b>	<b>28'80€</b>

Modelos para MK-dent®		Descripción
 	Trasero HE21 Trasero HE21L Trasero HE17 (HE010000 < N/S < HE023799)	Delantero HE22 Delantero HE22L
<b>Ref.: ROD-224</b>		<b>27,80 €</b>
 	Trasero HC20 Trasero HC20L Trasero HE17 (N/S < HE023800)	<b>Medidas:</b> 3,175x6,439x2,413mm Exterior: Con rebaje Bola: Cerámica Contacto: Angular Retenedor: Torlon Cerrado
<b>Ref.: ROD-228</b>		<b>17,80 €</b>

# REPUESTOS PARA CONTRA ÁNGULOS Y PIEZAS DE MANO KAVO®

Rotores compatibles contra ángulos KaVo®

RUMAR

	Modelos para KaVo®	Relacionados
	INTRA LUX 68LU INTRA LUX 68LH INTRAhead L68  Ref.: <b>BVR-705</b> (Ref. KaVo®: 0.540.3661)	EXPERTmatic E20L EXPERTmatic E20C INTRAcompact 2068LHC  INTRAcompact 2068CHC  Eje Ref.: BVE-724 Tapa Ref.: BVT-704  <b>94<sup>80</sup>€</b>
	INTRA LUX 67LH INTRA L67 INTRA 67LHB  Ref.: <b>BVR-468</b> (Ref. KaVo®: 0.540.3671)	EXPERTmatic E15L EXPERTmatic E15C INTRAcompact 0767LHC  INTRAcompact 0767CHC  Eje Ref.: BVE-398 Tapa Ref.: BVT-704  <b>99<sup>80</sup>€</b>
	INTRA LUX 68LDN  Ref.: <b>BVR-720</b> (Ref. KaVo®: 0.540.2491)	Eje Ref.: BVE-724 Tapa Ref.: BVT-711  <b>84<sup>80</sup>€</b>
	INTRA LUX C3 INTRA LUX CL3 SURGmatic S201L  Ref.: <b>BVR-414</b> (Ref. KaVo®: 1.001.4490)	Eje Ref.: BVE-402 Tapa Ref.: BVT-401  <b>128<sup>00</sup>€</b>
	INTRAmatic 25LH INTRAmatic LHC INTRAmatic 25LHS  Ref.: <b>BVR-370K</b> (Ref. KaVo®: 0.553.7341 / 0.553.5761)	INTRAmatic 25CN INTRAmatic 25CH INTRAmatic LUX 24LN  INTRAmatic LUX 24LS  Eje Ref.: BVE-460 Segundo Eje Ref.: BVE-462  <b>228<sup>00</sup>€</b>
	EXPERTmatic E25 EXPERTmatic E25L  Ref.: <b>BVR-372K</b> (Ref. KaVo®: 1.008.4040)	Eje Ref.: BVE-449 Tapa Ref.: BVT-446  <b>228<sup>00</sup>€</b>
	GENTLEpower LUX 25LP GENTLEpower LUX 25LPA  Ref.: <b>BVR-371K</b> (Ref. KaVo®: 1.001.3520 / 1.002.6135)	COMFORTdrive 200XD COMFORTdrive 200XDR  Eje Ref.: BVE-448  <b>228<sup>00</sup>€</b>
	MASTERmatic Lux M25L  Ref.: <b>BVR-424</b> (Ref. KaVo®: 1.011.0129)	Eje Ref.: BVE-448 Tapa Ref.: BVT-447  <b>188<sup>00</sup>€</b>
	MASTERmatic® LUX M05L  Ref.: <b>BVR-425</b> (Ref. KaVo®: 1.011.1374 / 1.009.3643)	Eje Ref.: BVE-463 Segundo Eje Ref.: BVE-462 Tapa Ref.: BVT-448  <b>222<sup>80</sup>€</b>

NUEVO

SI NO ENCUENTRAS EL REPUESTO QUE BUSCAS, ¡CONSÚLTANOS!  
 Precios: impuestos, portes y mano de obra no incluidos.







RUMAR

Modelos para KaVo®		Relacionados	
	<p>Piñón transmisión 1:1 para: INTRA LUX 68LU INTRA LUX 68LH INTRAhead L68</p> <p>EXPERTmatic E20L INTRAcompact 2068LHC</p>		
	<b>Ref.: BVR-701</b> (Ref. KaVo®: 0.540.4012)	<b>37'80€</b>	
	<p>Piñón transmisión 1:1 para: INTRA LUX 68LDN</p>		
	<b>Ref.: BVR-710</b> (Ref. KaVo®: 0.540.4092)	<b>44'80€</b>	
	<p>Piñón reducción 2:1 para: INTRA LUX 67LH INTRA L67 INTRA 67LHB</p>		
	<b>Ref.: BVR-721</b> (Ref. KaVo®: 0.540.4022)	<b>38'80€</b>	
	<p>Corona para: 67RIC <b>***Original KaVo***</b></p>		
	<b>Ref.: BVR-805</b> (Ref. KaVo®: 0.540.2761)	<b>101'80€</b>	HASTA AGOTAR
	<p>Rotor completo: 67RIC <b>***Original KaVo***</b></p>		
	<b>Ref.: BVR-808</b> (Ref. KaVo®: 0.540.2791)	<b>165'80€</b>	HASTA AGOTAR

## Ejes compatibles contra ángulos KaVo®



RUMAR

Modelos para KaVo®		Relacionados	
	<p>INTRA LUX 68LH INTRA LUX 68LDN INTRAhead L80 INTRAhead L68</p> <p>INTRA LUX 52LDN INTRA LUX 80LD EXPERTmatic E20L INTRA 80G</p> <p>INTRAcompact 2068LHC INTRAcompact 2068CHC</p>		
	<b>Ref.: BVE-724</b> (Ref. KaVo®: 0.540.1151)	<b>48'00€</b>	
	<p>INTRA LUX 67LH INTRA 67LHB INTRA 67LDN</p> <p>INTRA 67G INTRA L67 INTRA 67CN</p> <p>67HC INTRAprophy L31 31LR</p>		
	<b>Ref.: BVE-398</b> (Ref. KaVo®: 0.540.1161)	<b>48'00€</b>	
	<p>Corona eje de transmisión para: 68LH 68LDN L68</p>		
	<b>Ref.: BVE-725</b>	<b>9'80€</b>	

Modelos para KaVo®		Relacionados	
	INTRA LUX CL3 SURGmatic S201L	INTRA LUX C3 INTRA LUX CP3	
	<b>Ref.: BVE-402</b> (Ref. KaVo®: 1.003.4207)		<b>58'00€</b>
 <small>Imagen no disponible</small>	INTRACompact 2068LHC INTRACompact 2068CHC EXPERTmatic® E20C	EXPERTmatic® Lux E20L EXPERTmatic® S20 EXPERTmatic® S20S	MASTERmatic® Lux M20L
	<b>Ref.: BVE-1010</b> (Ref. KaVo®: 0.534.0681)		<b>38'00€</b>
	INTRAMatic 25LH INTRAMatic 25LHS INTRAMatic 25CN	INTRAMatic 25CH	
	<b>Ref.: BVE-460</b> (Ref. KaVo®: 0.553.7201)		<b>148'00€</b>
	GENTLEpower LUX 25LP GENTLEpower LUX 25LPA MASTERmatic Lux M25L		
	<b>Ref.: BVE-448</b> (Ref. KaVo®: 1.001.3515)		<b>149'80€</b>
	EXPERTmatic E25 EXPERTmatic E25L		
	<b>Ref.: BVE-449</b> (Ref. KaVo®: 1.007.9916)		<b>158'00€</b>
	Eje "segundo" GENTLEpower LUX 25LP Eje "segundo" GENTLEpower LUX 25LPA Eje "segundo" MASTERmatic M05L		
	<b>Ref.: BVE-462</b> (Ref. KaVo®: 1.001.3519)		<b>139'80€</b>
	MASTERmatic® LUX M05L		
	<b>Ref.: BVE-463</b> (Ref. KaVo®: 1.011.3206)		<b>169'80€</b>

### Tapas compatibles contra ángulos KaVo®

RUMAR

Modelos para KaVo®		Observaciones	
	3 muescas INTRA LUX 68LH INTRA LUX 67LH INTRA LUX L68 INTRA LUX L67	INTRAMatic 25LH INTRAMatic 25LHS INTRAMatic 25CN	INTRAMatic 25CH INTRAMatic 25LS INTRAMatic LUX 24LN
	<b>Ref.: BVT-704</b> (Ref. KaVo®: 0.540.3741)		<b>25'80€</b> Llave Doble Ref.: HE-751
	INTRA LUX 68LDN, INTRA LUX 67LDN, INTRA LUX 68GDN		Llave Doble Ref.: HE-751
	<b>Ref.: BVT-711</b> (Ref. KaVo®: 0.540.2501)		<b>29'80€</b>















Modelos para KaVo®		Relacionados
	INTRA LUX CL3 INTRA LUX C3 SURGICmatic S201L  <b>Ref.: BVT-401</b> (Ref. KaVo®: 0.201.8958 + 0.540.3752 + 1.001.4486)	<b>28'00€</b>  Llave Ref. : HE-832
	EXPERTmatic E25L EXPERTmatic E25C  <b>Ref.: BVT-446</b> (Ref. KaVo®: 1.008.1488)	<b>24'80€</b>  Llave Ref. : HE-819
	MASTERmatic Lux M25L  <b>Ref.: BVT-447</b> (Ref. KaVo®: 1.009.3634 + 0.201.8157 + 1.009.3638)	<b>24'80€</b>
 <small>Imagen no disponible</small>	MASTERmatic® Lux M05L*  <b>Ref.: BVT-448</b> (Ref. KaVo®: 3.000.6597 + 0.201.8157 + 3.000.6319)	<b>61'80€</b>  Llave Ref: HE-850 * Llave HE-850 necesaria, puntos de contacto distintos a original









## Anillos Tóricos Contra Ángulos y Piezas de Mano KaVo®

# RUMAR

Descripción	Observaciones
 20CN 20LN 20CH  20LH 10CH 10LH  E20C E20CL  <b>Ref.: OR-1020</b> (Ref. KaVo®: 0.200.6099)	<b>1'80€</b>
 <small>Imagen no disponible</small> EXPERTmatic® E25 / E25L GENTLEpower® 25LP / 25LPA MASTERmatic® LUX M05L  <b>***Original KaVo***</b>  <b>Ref.: OR-4929</b> (Ref. KaVo®: 1.003.4929 / 10)	MASTERmatic® LUX M25L OTROS MODELOS  Pack 1 uds.  <b>3'40€</b>
 <small>Imagen no disponible</small> EXPERTmatic® E25 / E25L GENTLEpower® 25LP / 25LPA MASTERmatic® LUX M05L  <b>***Original KaVo***</b>  <b>Ref.: OR-3289</b> (Ref. KaVo®: 1.001.3289 / 10)	MASTERmatic® LUX M25L OTROS MODELOS  Pack 1 uds.  <b>2'80€</b>
 <small>Imagen no disponible</small> EXPERTmatic® E25 / E25L GENTLEpower® 25LP / 25LPA  <b>***Original KaVo***</b>  <b>Ref.: OR-6045</b> (Ref. KaVo®: 0.200.6045)	MASTERmatic® LUX M05L MASTERmatic® LUX M25L OTROS MODELOS  Pack 1 uds.  <b>4'40€</b>

## Resto repuestos compatibles contra ángulos KaVo®

	Descripción	Observaciones
	Conjunto repuestos cabeza 68LDN (Rotor completo + carcasa + botón + eje + tornillo + muelle) <b>Ref.: BVX-740</b>	170 <sup>00</sup> €
	Carcasa 68LH <b>Ref.: BVX-706</b> (Ref. KaVo®: 0.540.3631)	54 <sup>80</sup> €
	Carcasa 67LH <b>Ref.: BVX-2101</b> (Ref. KaVo®: 0.540.3641)	63 <sup>80</sup> €
	Carcasa 80LD <b>Ref.: BVX-2221</b> (Ref. KaVo®: 0.540.2381)	58 <sup>00</sup> € <b>HASTA AGOTAR</b>
	Carcasa completa 68LDN, 68GDN <b>Ref.: BVX-712</b> (Ref. KaVo®: 0.540.2231)	58 <sup>80</sup> €
	Segmento 68LH, L68, 67LH, L67, 68LDN y 67LDN <b>Ref.: BVX-702</b> (Ref. KaVo®: 0.540.4102)	7 <sup>80</sup> €
	Chaveta 68LH, L68, 67LH, L67, 68LDN y 67LDN <b>Ref.: BVX-703</b> (Ref. KaVo®: 0.540.4522)	12 <sup>80</sup> €
	Anillo de conducción 68LH, L68, 67LH, L67, 68LDN y 67LDN <b>Ref.: BVX-707</b> (Ref. KaVo®: 0.540.4072)	1 <sup>10</sup> € <b>Útil Ref.: HE-752</b>
	Muelle 68LH, L68, 67LH, L67, 68LDN y 67LDN <b>Ref.: BVX-709</b> (Ref. KaVo®: 0.540.3162)	2 <sup>60</sup> €
	Muelle para 20LH, 2068CHC, 2068LHC, 20CH, E20, E20L y compatibles <b>Ref.: BVX-1004</b> (Ref. KaVo®: 0.201.7442)	1 <sup>30</sup> € <b>HASTA AGOTAR</b>
	Muelle para 20LH, 2068CHC, 2068LHC, 20CH, E20 y E20L <b>Ref.: BVX-1014</b> (Ref. KaVo®: 0.201.8022)	1 <sup>80</sup> €
	Tornillo 68LH, L68, 67LH, L67, 68LDN y 67LDN <b>Ref.: BVX-708</b> (Ref. KaVo®: 0.201.0005)	1 <sup>90</sup> € <b>Destornillador: HE-2016, HE-753TOR.</b>
	Anillo cierre para 20LH, 2068CHC, 2068LHC, 20CH, 20CH, E20 y E20L <b>Ref.: BVX-1003</b> (Ref. KaVo®: 0.534.4012)	26 <sup>40</sup> € <b>HASTA AGOTAR</b>
	Anillo alambre para 20LH, 2068CHC, 2068LHC, 20CH, E20, E20L y compatibles <b>Ref.: BVX-1005</b> (Ref. KaVo®: 0.534.3532)	1 <sup>80</sup> €







	Descripción	Observaciones
	Bola para 20LH, 2068CHC, 2068LHC, 20CH, E20 y E20L <b>Ref.: BVX-1006</b> (Ref. KaVo®: 0.257.4118) <b>1'80€</b>	3,0 mm
	Bola para 20LH, 2068CHC, 2068LHC, 20CH, E20 y E20L <b>Ref.: BVX-1007</b> (Ref. KaVo®: 0.257.4105) <b>0'80€</b>	1,5 mm <b>HASTA AGOTAR</b>
	Distanciador para 20LH, 2068CHC, 2068LH, 20CHC, E20 y E20L <b>Ref.: BVX-1012</b> (Ref. KaVo®: 0.553.1602) <b>4'70€</b>	<b>HASTA AGOTAR</b>
	Tope arrastre trasero para 20LH, 2068CHC, 2068LHC, 20CH, E20 y E20L <b>Ref.: BVX-1016</b> (Ref. KaVo®: 0.524.3182) <b>30'80€</b>	
	Pasador tope de arrastre para 20LH, 2068LHC, 20CH, E20 y E20L <b>Ref.: BVX-1017</b> (Ref. KaVo®: 0.202.0504) <b>1'50€</b>	
	Inserto 20CH, 2068CHC y E20 <b>Ref.: BVX-1019</b> (Ref. KaVo®: 0.534.4042) <b>65'90€</b>	<b>HASTA AGOTAR</b>
	Inserto 20LH, 2068LH y E20L <b>Ref.: BVX-1019L</b> (Ref. KaVo®: 0.534.4082) <b>65'90€</b>	<b>HASTA AGOTAR</b>
	Guía posicionamiento 20LH, 2068LH y E20L (NO válido para líneas LE, LC o LP) <b>Ref.: BVX-1023</b> (Ref. KaVo®: 0.534.2442) <b>19'60€</b>	<b>HASTA AGOTAR</b>
	MASTERmatic® LUX M05L MASTERmatic® LUX M25L <b>Ref.: BVX-3643</b> (Ref. KaVo®: 1.009.3643) <b>2'80€</b>	

## Repuestos piezas de mano KaVo®

RUMAR

	Descripción	Observaciones
	Anillo cierre para 10LH y 10CH <b>Ref.: BVX-1039</b> (Ref. KaVo®: 0.524.1561) <b>55'80€</b>	
	Cartucho para rodamiento 10LH y 10CH <b>Ref.: BVX-1040</b> (Ref. KaVo®: 0.524.3252) <b>48'20€</b>	<b>HASTA AGOTAR</b>
	Anillo para 10LH y 10CH <b>Ref.: BVX-1041</b> (Ref. KaVo®: 0.524.2742) <b>8'00€</b>	<b>HASTA AGOTAR</b>
	Perno para 10LH y 10CH <b>Ref.: BVX-1042</b> (Ref. KaVo®: 0.524.3262) <b>5'50€</b>	<b>HASTA AGOTAR</b>











	Descripción		Observaciones
	Anillo roscado para 10LH y 10CH <b>Ref.: BVX-1043</b> (Ref. KaVo®: 0.524.2772)	6'90€	HASTA AGOTAR
	Arandela para 10LH y 10CH <b>Ref.: BVX-1044</b> (Ref. KaVo®: 0.524.2762)	4'40€	HASTA AGOTAR
	Tornillo para 10LH y 10CH <b>Ref.: BVX-1045</b> (Ref. KaVo®: 0.201.0401)	1'40€	HASTA AGOTAR
	Inserto para 10LH y 10CH <b>Ref.: BVX-1046</b> (Ref. KaVo®: 0.524.4012)	64'20€	HASTA AGOTAR
	Clip para 10LH y 10CH <b>Ref.: BVX-1047</b> (Ref. KaVo®: 0.524.3642)	1'90€	HASTA AGOTAR
	Tope arrastre trasero para 10LH y 10CH <b>Ref.: BVX-1016</b> (Ref. KaVo®: 0.524.3182)	30'80€	
	Pasador tope arrastre para 10LH y 10CH <b>Ref.: BVX-1017</b> (Ref. KaVo®: 0.202.0504)	1'50€	











# REPUESTOS PARA CONTRA ÁNGULOS Y PIEZAS DE MANO NSK®





Rotores compatibles contra ángulos NSK®

RUMAR

	Modelos para NSK®	Relacionados
	Ti-Max Ti25 Ti-Max Ti25L Ti-Max Ti15  <b>Ref.: BVR-380</b>	Ti-Max Ti15L FPB-Y FFB-Y  <b>68<sup>80</sup>€</b>
	Ti-Max X95 Ti-Max X95L S-MAX M95  <b>Ref.: BVR-384</b> (Ref. NSK®: C600 015 / C600C015003 / C600C015002)	Eje Ti25 y Ti15 Ref.: BVE-396 Eje FPB-Y y FFB-Y Ref.: BVE-400 Tapa Ref.: BVT-387 Juntas: OR-7064 y OR-7062  <b>159<sup>80</sup>€</b>
	Ti-Max X25 Ti-Max X25L Ti-Max X15  <b>Ref.: BVR-388</b> (Ref. NSK®: C601 015 / C601015001)	Ti-Max X15L S-Max M25 * S-Max M25L*  <b>82<sup>80</sup>€</b>
	Rodamiento delantero: 3,175 x 6,42 x 1,53mm   Rodamiento trasero: 3,175 x 6,42 x 1,53 mm Ti-Max Z95 Ti-Max Z95L (Modelo antiguo)  <b>Ref.: BVR-463</b> (Ref. NSK®: C1034015)	Eje X25 Ref.: BVE-389 Eje M25 Ref.: BVE-390 (Rotor cerrado) Tapa Ref. (Todos): BVT-387 Juntas: OR-7064 y OR-7062 Llave: HE-610  *Para rotores abiertos ver Ref.: BVR-457  <b>158<sup>00</sup>€</b>
	Rodamiento delantero: 3,175 x 6,42 x 1,53mm   Rodamiento trasero: 3,175 x 6,82 x 1,80 mm Ti-Max Z95 Ti-Max Z95L (Modelo nuevo)  <b>Ref.: BVR-466</b> (Ref. NSK®: C1034D017)	Eje Z25 Ref.: BVE-465 Tapa Ref.: BVT-456 Juntas: OR-4061  <b>158<sup>00</sup>€</b>
	FX15 FX25 X23  <b>Ref.: BVR-454</b>	Eje Z25 Ref.: BVE-465 Tapa Ref.: BVT-456  <b>58<sup>00</sup>€</b>
	TI-MAX Z25 TI-MAX Z25L TI-MAX Z15 TI-MAX Z15L  <b>Ref.: BVR-457</b> (Ref. NSK®: C1038015)	S-MAX M25 * S-MAX M25L * Nano 25LS  <b>84<sup>80</sup>€</b>
	S-Max SG20 S-Max SG20L TI-Max X-SG20L  <b>Ref.: BVR-394</b> (Ref. NSK®: C1010150002 / C1010150001)	Eje M25 Ref.: BVE-423 (Rotor abierto) Tapa Ref. Z25: BVT-459 Tapa Ref. M25: BVT-419 (Rotor abierto) Juntas: OR-4061 y OR-8060  *Para rotores cerrados ver Ref.: BVR-388  <b>88<sup>00</sup>€</b>
		Incluye: arandela azul y arandela metálica  Eje Ref. S-MAX SG20: BVE-395 Eje Ref. TI-MAX SG20: BVE-422 Eje Ref. TI-MAX X-DSG20L: BVE-450 Tapa Ref.: BVT-391

## Ejes compatibles contra ángulos NSK®







	Modelos para NSK®	Relacionados
	Ti-Max Ti25 Ti-Max Ti25L  <b>Ref.: BVE-396</b>	<b>48<sup>00</sup>€</b>
	FPB-Y FFB-Y  <b>Ref.: BVE-400</b>	<b>48<sup>00</sup>€</b>
	Ti-Max X95 Ti-Max X95L  <b>Ref.: BVE-385</b> (Ref. NSK®: C600 022)	<b>108<sup>00</sup>€</b>
	S-Max M95 (Modelo antiguo) S-Max M95L (Modelo antiguo)  <b>Ref.: BVE-386</b> (Ref. NSK®: 10000559)	<b>118<sup>00</sup>€</b>
	S-Max M95 (Modelo nuevo) S-Max M95L (Modelo nuevo)  <b>Ref.: BVE-399</b> (Ref. NSK® C601 022)	<b>118<sup>00</sup>€</b>
	Ti-Max X25 Ti-Max X25L  <b>Ref.: BVE-389</b> (Ref. NSK®: C601 022)	<b>48<sup>00</sup>€</b>
	S-Max M25 (Rotor cerrado)* S-Max M25L (Rotor cerrado)*  <b>Ref.: BVE-390</b> (Ref. NSK®: 1000574)	<b>48<sup>00</sup>€</b>  * Para rotor abierto ver referencia BVE-423
	S-Max M25 (Rotor abierto)* S-Max M25L (Rotor abierto)*  <b>Ref.: BVE-423</b> (Ref. NSK®: C1142022)	<b>89<sup>80</sup>€</b>  * Para rotor cerrado ver referencia BVE-390
	Corona superior para eje: S-MAX M25 S-MAX M25L  <b>Ref.: BVE-393</b>	<b>10<sup>80</sup>€</b>  <b>HASTA AGOTAR</b>
	S-Max SG20 S-Max SG20L  <b>Ref.: BVE-395</b> (Ref. NSK®: C1010022 / 10000229001)	<b>98<sup>00</sup>€</b>  Llave Ref.: HE-950

Modelos para NSK®		Relacionados
	Ti-Max X-SG20 Ti-Max X-SG20L  <b>Ref.: BVE-422</b> (Ref. NSK®: C1003022 /10000255001)	<b>Llave Ref.: HE-950</b>  <b>98<sup>00</sup>€</b>
	Ti-Max X-DSG20L  <b>Ref.: BVE-450</b> (Ref. NSK®: C1068912)	<b>Llave Ref.: HE-950</b>  <b>149<sup>80</sup>€</b>
	FX15 FX25 FX23  <b>Ref.: BVE-455</b> (Ref. NSK®: C10000946)	<b>54<sup>80</sup>€</b>
	Ti-Max Z25 Ti-Max Z25L  <b>Ref.: BVE-458</b> (Ref. NSK®: C1038022)	<b>59<sup>80</sup>€</b>
	Ti-Max Z95 Ti-Max Z95L  <b>Ref.: BVE-465</b> (Ref. NSK®: C1034022002)	<b>149<sup>80</sup>€</b>

### Tapas compatibles contra ángulos NSK®



RUMAR



Modelos para NSK®		Relacionados
	Ti-Max T125 Ti-Max T125L Ti-Max X15 Ti-Max X15L  Ti-Max X25 Ti-Max X25L S-Max M25 (Rotor cerrado)* S-Max M25L (Rotor cerrado)*  <b>Ref.: BVT-387</b> (Ref. NSK®: C601 050)	<b>Llave Ref.: HE-610</b> <b>Llave Ref.: HE-613</b>  *Para rotores abiertos ver Ref. BVT-419  <b>19<sup>80</sup>€</b>
 <small>Imagen no disponible</small>	S-Max M25 (Rotor abierto)* S-Max M25L (Rotor abierto)*  <b>Ref.: BVT-419</b> (Ref. NSK®: C1142050)	<b>Llave Ref.: HE-762</b> <b>Llave Doble Ref.: HE-615</b>  *Para rotores cerrados ver Ref. BVT-387  <b>56<sup>80</sup>€</b>
	S-Max M95 S-Max M95L Ti-Max X95 Ti-Max X95L  <b>Ref.: BVT-404</b>	<b>Llave Ref.: HE-762</b> <b>Llave Doble Ref.: HE-615</b>  <b>22<sup>80</sup>€</b>
	MP-Y MP-F MPA-Y  MPAS-Y  <b>Ref.: BVT-403</b>	<b>Llave Ref.: HE-611</b>  <b>28<sup>00</sup>€</b>

	Modelos para NSK®	Relacionados
	Arandela metálica cabeza: S-Max SG20 S-Max SG20L Ti-Max X-SG20L  <b>Ref.: BVX-400MD</b> (Ref. NSK®: 20000341)	
	Arandela goma azul: S-Max SG20 S-Max SG20L Ti-Max X-SG20L  <b>Ref.: BVX-400RD</b> (Ref. NSK®: C495360A)	
	S-Max SG20 S-Max SG20L Ti-Max X-SG20L  <b>Ref.: BVT-391</b> (Ref. NSK®: 10000228)	Llave Ref.: HE-616
	FX15 FX25 FX23  <b>Ref.: BVT-456</b> (Ref. NSK®: C1052500)	Llave Ref.: HE-839
	Ti-Max Z25 Ti-Max Z25L  <b>Ref.: BVT-459</b>	
	Ti-Max Z95 (Modelo antiguo) Ti-Max Z95L (Modelo antiguo)  <b>Ref.: BVT-464</b> (Ref. NSK®: C1038015)	Llave Ref.: HE-615
	Ti-Max Z95 (Modelo nuevo) Ti-Max Z95L (Modelo nuevo)  <b>Ref.: BVT-467</b> (Ref. NSK®: C1034050)	

## Anillos Tóricos Contra Ángulos y Piezas de Mano NSK®

RUMAR







	Modelos para NSK®	
 <small>Imagen no disponible</small>	Retenedor junta cuello contra ángulos NSK® S-Max M25 (Rotor cerrado)      Ti-Max Tí25 S-Max M25L (Rotor cerrado)      Ti-Max Tí25L  ***Original NSK®*** <b>Ref.: OR-7062</b> (Ref. NSK®: C387062)	Pack 2 uds.  <b>9'80€</b>
 <small>Imagen no disponible</small>	Junta cuello contra ángulos NSK® S-Max M25 (Rotor cerrado y rotor abierto)      S-Max M95 S-Max M25L (Rotor cerrado y rotor abierto)      S-Max M95L Ti-Max Tí25 Ti-Max Tí25L  ***Original NSK®*** <b>Ref.: OR-7064</b> (Ref. NSK®: C427064)	Ti-Max X25 Ti-Max X25L Ti-Max X95 Ti-Max X95L  <b>9'80€</b>









Modelos para NSK®		Relacionados
 <small>Imagen no disponible</small>	<p>Anillo tórico cuello contra ángulo NSK® Ti-Max Z25                      Ti-Max Z95 Ti-Max Z25L                      Ti-Max Z95L</p> <p><b>***Original NSK***</b></p> <p><b>Ref.: OR-4061</b> (Ref. NSK®: C1034061)</p>	Pack 2 uds.       <b>9<sup>80</sup>€</b>
 <small>Imagen no disponible</small>	<p>Retenedor anillo tórico cuello contra ángulos NSK: Ti-Max Z25 Ti-Max Z25L</p> <p><b>***Original NSK***</b></p> <p><b>Ref.: OR-8060</b> (Ref. NSK®: C1038060)</p>	Pack 2 uds.       <b>9<sup>80</sup>€</b>

## REPUESTOS PARA CONTRA ÁNGULOS Y PIEZAS DE MANO W&H®











Rotores compatibles contra ángulos W&H®

RUMAR







Modelos para W&H®		Relacionados
	<p>WS-75 LED G **                      WS-75 LG **                      WI-75 LED G *</p> <p>WS-75 E ***                      WI-75 E *</p> <p>WS-75 KM ***                      WI-75 KM *</p> <p><b>(Confirmar con imagen)</b></p> <p><b>Ref.: BVR-399</b> (Ref. W&amp;H®: 04939900)</p>	<p>*Eje Ref.: BVE-381 **Eje Ref.: BVE-378 ***Eje Ref.: BVE-415 (Rev. N/S) Tapa Ref.: BVT-376</p> <p><b>128<sup>00</sup>€</b></p>
	<p>WS-75 E (01001 &lt; N/S &lt; 25335) WS-75 KM (01001 &lt; N/S &lt; 25335) <b>(Confirmar con imagen)</b></p> <p><b>Ref.: BVR-453</b> (Ref. W&amp;H®: 04651800)</p>	<p><b>***Necesario cambiar eje y tapa, contra ángulo antiguo***</b></p> <p>Eje Ref.: BVE-415 Tapa Ref.: BVT-376</p> <p><b>108<sup>00</sup>€</b></p>
	<p>Alegra® WE-56 Alegra® WE-56E Synea® WA-56A (antiguo)</p> <p><b>Ref.: BVR-370</b> (Ref. W&amp;H®: 03819000, 05843300)</p>	<p>Rodamientos: 2mm</p> <p>Eje Ref.: BVE-374 Tapa Ref.: BVT-379</p> <p><b>68<sup>80</sup>€</b></p>
	<p>Alegra® WE-56 LED G Alegra® WE-56A</p> <p><b>Ref.: BVR-443</b> (Ref. W&amp;H®: 05844400)</p>	<p>Tapa Ref.: BVT-379</p> <p><b>74<sup>80</sup>€</b></p>
	<p>Piñón para: Alegra® WE-56 Alegra® WE-56E Alegra® WA-56A (antiguo)</p> <p><b>Ref.: BVR-371</b></p>	<p><b>39<sup>80</sup>€</b></p>
	<p>Alegra® WE-56 Alegra® WE-56LT</p> <p><b>Ref.: BVR-477</b> (Ref. W&amp;H®: 07539000)</p>	<p><b>158<sup>00</sup>€</b></p>

	Modelos para W&H®	Relacionados
	Alegra® WE-99 Alegra® WE-99 LED G  <b>Ref.: BVR-478</b> (Ref. W&H®: 05846100)	<b>Eje Ref.: BVE-443</b> <b>Tapa Ref.: BVT-474</b>  <b>148'00€</b>
	Synea® WA-56 (desde 2007) Synea® WA-56LT (desde 2007) Synea® WA-66 (desde 2007) Synea® WA-66A (desde 2007) Synea® WA-66LT (desde 2007)  Synea®@ Vision WK-56 (N/S<04013) Synea®@ Vision WK-66 (N/S<01906)  <b>Ref.: BVR-375</b> (Ref. W&H®: 05431100)	<b>Rodamientos: 1,6mm</b> <b>Eje Ref.: BVE-439</b> <b>Tapa Ref.: BVT-377</b>  <b>68'80€</b>
	Synea® WA-99LT (desde 2007)  <b>Ref.: BVR-427</b> (Ref. W&H®: 05220300)	<b>Tapa Ref.: BVT-413</b>  <b>223'80€</b>
	Fusion WG-99LT (SN > 007802) Vision WK-99LT (SN > 01001)  <b>Ref.: BVR-442</b> (Ref. W&H®: 07473400)	<b>Eje Ref. WG-99LT: 44-440</b> <b>Eje Ref. WK-99: 44-441</b>  <b>108'00€</b>
	Rotor completo y tapa botón para: Trend WD-56  <b>Ref.: BVR-426</b> (Ref. W&H®: 03425000)	<b>Eje Ref.: BVE-425</b> <b>Tapa Ref.: BVT-412</b>  <b>80'00€</b>
 <small>Imagen no disponible</small>	Synea® WA-99LT (hasta 2007) Synea® WA-99A (hasta 2009)  <b>Ref.: BVR-479</b> (Ref. W&H®: 04517200)	<b>Eje Ref.: BVE-438</b>  <b>298'00€</b> <b>BAJO PEDIDO</b>
 <small>Imagen no disponible</small>	Fusion WG-56LT (N/S<014633)  <b>Ref.: BVR-481</b> (Ref. W&H®: 06994300)	<b>Eje Ref.: BVE-439</b>  <b>178'00€</b> <b>BAJO PEDIDO</b>
 <small>Imagen no disponible</small>	Fusion WG-56LT (N/S<014634) Fusion WG-56A (N/S<002462)  <b>Ref.: BVR-480</b> (Ref. W&H®: 07605900)	<b>Eje Ref.: BVE-486</b>  <b>88'00€</b>
 <small>Imagen no disponible</small>	Fusion WG-99LT (N/S<007801) Fusion WG-99 LED G (N/S<007801) Fusion WG-99A (N/S<001818)  <b>Ref.: BVR-482</b> (Ref. W&H®: 06993900)	<b>258'00€</b>

## Ejes compatibles contra ángulos W&amp;H®



Modelos para W&H®			Relacionados
	WS-75 E WS-75 KM *modelo fabricado hasta 2008 (SN 01001 to 25335)		(Eje montaje atornillable)  Llave Ref.: HE-950
	<b>Ref.: BVE-415</b> (Ref. W&H®: 04016900)	<b>108<sup>00</sup>€</b>	
	WI-75 LED G WI-75 E WI-75 KM  (Confirmar con imagen)		(Eje montaje atornillable)  Llave Ref.: HE-950
	<b>Ref.: BVE-381</b> (Ref. W&H®: 04667600)	<b>108<sup>00</sup>€</b>	
	WS-75 LED G WS-75 LG		(Eje montaje NO atornillable)
	<b>Ref.: BVE-378</b> (Ref. W&H®: 06025100)	<b>108<sup>00</sup>€</b>	
	Alegra® WE-56 Alegra® WE-56E		
	<b>Ref.: BVE-374</b> (Ref. W&H®: 05852500)	<b>59<sup>80</sup>€</b>	
	Corona superior para eje: Alegra® WE-56 Alegra® WE-56E Alegra® WE-56 LED		
	<b>Ref.: BVE-382</b>	<b>10<sup>80</sup>€</b>	HASTA AGOTAR
	Corona inferior para eje: Alegra® WE-56 Alegra® WE-56E		
	<b>Ref.: BVE-383</b>	<b>10<sup>80</sup>€</b>	HASTA AGOTAR
	Synea® WA-56A (desde 2007 / nuevo) Synea® WA-56LT (desde 2007 / nuevo) Fusion WG-56LT (N/S 001001-014633)		
	<b>Ref.: BVE-439</b> (Ref. W&H®: 05233200)	<b>138<sup>00</sup>€</b>	
 Imagen no disponible	Fusion® WG-56LT (N/S > 014634) Vision® WK-56LT (N/S > 04014) Vision® WK-56S		
	<b>Ref.: BVE-486</b> (Ref. W&H®: 06796000)	<b>88<sup>00</sup>€</b>	
	Trend WD-56		Llave Ref.: HE-950
	<b>Ref.: BVE-425</b> (Ref. W&H®: 03403500)	<b>48<sup>00</sup>€</b>	
 Imagen no disponible	WA-99A (hasta 2007)* WA-99LT (hasta 2007)*		* Contra ángulos con 2 anillos rojos y triple spray
	<b>Ref.: BVE-438</b> (Ref. W&H®: 03816000)	<b>206<sup>80</sup>€</b>	BAJO PEDIDO











	Modelos para W&H®	Relacionados
 Imagen no disponible	Synea® WA-99LT (desde 2007) Fusion WG-99LT (N/S 001001-007801) Fusion WG-99A (N/S 001001-001818)	
	<b>Ref.: BVE-440</b> (Ref. W&H®: 06420900)	<b>198<sup>100</sup>€</b> <span style="float: right; background-color: #28a745; color: white; padding: 2px 5px;">BAJO PEDIDO</span>
 Imagen no disponible	Fusion WG-99LT (SN > 007802) Vision WK-99LT (SN > 01001)	
	<b>Ref.: BVE-441</b> (Ref. W&H®: 06579200)	<b>205<sup>80</sup>€</b> <span style="float: right; background-color: #28a745; color: white; padding: 2px 5px;">BAJO PEDIDO</span>
	Alegre® WE-56 Alegre® WE-56T	Piezas de mano SIN anillo azul
	<b>Ref.: BVE-442</b> (Ref. W&H®: 07250900)	<b>116<sup>80</sup>€</b>
	Alegre® WE-99A Alegre® WE-99 LED G	Fusion® WG-99LT (N/S < 007801) Fusion® WG-99 LED G (N/S < 007801)
	<b>Ref.: BVE-443</b> (Ref. W&H®: 05845500)	<b>176<sup>80</sup>€</b>
	Fusion® WG-56LT (N/S > 014634) Vision® WK-56LT (N/S > 04014) Vision® WK-56S	
	<b>Ref.: BVE-444</b> (Ref. W&H®: 06795000)	<b>88<sup>100</sup>€</b>
	Synea® WA-66LT (desde 2007)	
	<b>Ref.: BVE-445</b> (Ref. W&H®: 05273000)	<b>161<sup>80</sup>€</b>
	Alegre® WE-56 LED Alegre® WE-56A	
	<b>Ref.: BVE-446</b> (Ref. W&H®: 05844300)	<b>121<sup>80</sup>€</b>

### ▶ Tapas compatibles contra ángulos W&H®

RUMAR

	Modelos para W&H®	Relacionados
	WS-75 WS-75E WS-75KM WS-75E (N/S>30000)	WS-75KM (N/S>30000) WI-75E (N/S>01001) WI-75KM (N/S>01001) WI-75 LED G (N/S>01001)
	<b>Ref.: BVT-376</b> (Ref. W&H®: 04940500)	WS-75 LED G (N/S DE 01001 a 25335) (modelos fabricados hasta 2008)
	Alegre® WE-56 (hasta 2007) Alegre® WE-56A (hasta 2007) Alegre® WE-56E (hasta 2007)	Alegre® WE-56 LED G (hasta 2008) Synea® WA-56A (antiguo rodamientos 2mm)
	<b>Ref.: BVT-379</b> (Ref. W&H®: 05843800)	<b>29<sup>80</sup>€</b>
	<b>*Rotores con Anillo Azul</b>	<b>Llave: HE-844</b>
		<b>Llave: HE-763</b>

Modelos para W&H®		Relacionados
	Synea® WA-56A (desde 2007) Synea® WA-56LT (desde 2007)  *Rotores sin Anillo Azul  <b>Ref.: BVT-377</b> (Ref. W&H®: 05112800 + 03819600 + 04952800 + 05280400)	Llave: HE-843  <b>29'80€</b>
	Alegra® WE-56 (desde 2008) Alegra® WE-56T (desde 2008) Alegra® WE-56 LED G (desde 2008)  <b>Ref.: BVT-472</b> (Ref. W&H®: 06993800)	Llave Ref.: HE-763  <b>80'00€</b>
	Trend WD-56  <b>Ref.: BVT-412</b>	Llave: HE-842  <b>29'80€</b>
	Synea® WA-99A (desde 2007) Synea® WA-99LT (desde 2007)  <b>Ref.: BVT-413</b> (Ref. W&H®: 07771800 + 07771700 + 04952800)	Llave Ref.: HE-820  <b>56'80€</b>
	Synea® WA-56LT (hasta 2007)  <b>Ref.: BVT-473</b> (Ref. W&H®: 05345200)	Llave: HE-842  <b>56'80€</b>
	Alegra® WE-99A Alegra® WE-99 LED G Fusion WG-99LED G (N/S <007801) Fusion WG-99LT (N/S <007801)  <b>Ref.: BVT-474</b> (Ref. W&H®: 05846000)	Llave Ref.: HE-763  <b>29'80€</b>
	Synea® WA-99A Synea® WA-99A LED (Hasta 2007)  <b>Ref.: BVT-475</b> (Ref. W&H®: 04943000)	Llave Ref.: HE-842  <b>80'00€</b>
	Fusion WG-99LT (N/S >007802) Visio WK-99LT (N/S >01001) Fusion WG-99A (N/S >001819)  <b>Ref.: BVT-476</b>	Llave Ref.: HE-763  <b>91'80€</b> <span style="background-color: #4CAF50; color: white; padding: 2px 5px;">BAJO PEDIDO</span>

### Resto repuestos compatibles contra ángulos W&H®

RUMAR

Descripción	Observaciones
 Chaveta para W&H.  <b>Ref.: BVX-372</b> (Ref. W&H® 03819300)	<b>12'80€</b>
 Anillo conducción para W&H.  <b>Ref.: BVX-373</b> (Ref. W&H® 03819200)	<b>1'40€</b>



	Descripción	Observaciones
	Chaveta para W&H  <b>Ref.: BVX-372</b> (Ref. W&H® 03819300)	<b>12<sup>80</sup>€</b>
	Anillo conducción para W&H.  <b>Ref.: BVX-373</b> (Ref. W&H® 03819200)	<b>1<sup>40</sup>€</b>
	Clip negro aguja de irrigación <b>***Original W&amp;H***</b>  WI-75 WI-75 E/KM  WI-75 LED G WS-75 E/KM (N/S > 030000)  WS-75 LED G	<b>Pack: 1 ud.</b>  <b>31<sup>80</sup>€</b>
	Clip verde aguja de irrigación <b>***Original W&amp;H***</b>  WS-75 WS-75 L G	<b>Pack: 1 ud.</b>  <b>31<sup>80</sup>€</b>

NUEVO

## REPUESTOS PARA CONTRA ÁNGULOS Y PIEZAS DE MANO BIEN AIR®

Rotores compatibles contra ángulos **Bien Air®**

RUMAR

	Modelos para Bien Air®	Relacionados
	1:5 1:5L  <b>Ref.: BVR-438</b> (Ref. Bien Air®: 1501933)	<b>Incluye:</b> arandela metal + 2 anillos tóricos  <b>Eje Ref.:</b> BVE-437 <b>Tapa Ref.:</b> BVT-445  <b>128<sup>00</sup>€</b>
	1:1 1:1L  <b>Ref.: BVR-377B</b> (Ref. Bien Air®: 1501085)	<b>Eje Ref.:</b> BVE--378B <b>Tapa Ref.:</b> BVT-0550  <b>98<sup>00</sup>€</b>
	20:1 20:1L  <b>Ref.: BVR-428</b>	<b>Eje Ref.:</b> BVE-429 <b>Tapa Ref.:</b> BVT-430  <b>98<sup>00</sup>€</b>





Ejes compatibles contra ángulos **Bien Air®**

RUMAR

Modelos para Bien Air®		Relacionados
	1:5 1:5L  <b>Ref.: BVE-437</b> (Ref. Bien Air®: 1500057)	<b>149<sup>80</sup>€</b>
	1:1  <b>Ref.: BVE-378B</b> (Ref. Bien Air®: 1500289)	<b>68<sup>00</sup>€</b>
	20:1 20:1L  <b>Ref.: BVE-429</b>	<b>88<sup>00</sup>€</b>

Tapas compatibles contra ángulos **Bien Air®**

RUMAR

Modelos para Bien Air®		Relacionados
	1:1 1:1 L  <b>Ref.: BVT-0550</b> (Ref. Bien Air®: 1500550)	Llave: HE-849  <b>29<sup>80</sup>€</b>
	1:5 1:5L  <b>Ref.: BVT-445</b> (Ref. Bien Air®: 1500169)	Llave: HE-849  <b>24<sup>80</sup>€</b>
	20:1 20:1L  <b>Ref.: BVT-430</b> (Ref. Bien Air®: 15010027)	Llave: HE-849  <b>29<sup>80</sup>€</b>
 <small>Imagen no disponible</small>	EVO 1:5 L <b>***Original Bien Air***</b>  <b>Ref.: BVT-486</b> (Ref. Bien Air®: 1502110)	<b>74<sup>80</sup>€</b>  <b>BAJO PEDIDO</b>

# REPUESTOS PARA CONTRA ÁNGULOS Y PIEZAS DE MANO SIRONA®

Rotores compatibles contra ángulos Sirona®

RUMAR

## Modelos para Sirona®

## Relacionados

	<p>T1 Line C200 (N/S&gt;30 000) T1 Line C200L (N/S&gt;43 000 / N/S&gt;65 000) T1 Classic S200L (N/S≤32 001)</p> <p>T2 Line A200L (N/S&lt;7804 / N/S&gt;7805) T2 Line A170L T3 Line E20 (N/S&lt;2325 / N/S&gt;2326) T3 Line E200L (N/S&lt;2325 / N/S&gt;2326)</p> <p>T2 Line A200 (N/S&lt;7804   N/S&gt;7805) A200L (N/S≤32 001) A170L T3 Line E200 (N/S&lt;2325 / N/S&gt;2326)</p> <p><b>Ref.: BVR-375S</b> (Ref. Sirona®: 6175587 / 6405687)</p> <p><b>228<sup>00</sup>€</b></p>	<p><b>Cabeza standard</b> <b>Rodamientos:</b> 3,175x7x2mm</p> <p><b>Eje Ref.:</b> BVE-451 <b>Tapa Ref.:</b> BVT-407</p>
	<p>T1 Classic S200L mini (3 000≤N/S≤30 000) T1 Line C200 mini (N/S&gt;30 000) T1 Line C200L mini (43 000≤N/S≤65 000)</p> <p><b>Ref.: BVR-378</b> (Ref. Sirona®: 6175611 / 6049345)</p> <p><b>268<sup>00</sup>€</b></p>	<p><b>Cabeza mini</b></p> <p><b>Eje Ref.:</b> BVE-451 <b>Tapa Ref.:</b> BVT-410</p>
	<p>T1 Line C40 T1 Line C40L T2 Line A40 T2 Line A40L</p> <p>T3 Line E40 T1 Classic S40</p> <p><b>Ref.: BVR-417</b> (Ref. Sirona®: 6000983)</p> <p><b>88<sup>00</sup>€</b></p>	<p><b>Cabeza standard</b></p> <p><b>Eje Ref.:</b> BVE-418 <b>Tapa A40 Ref.:</b> BVT-409 <b>Tapa C40 Ref.:</b> BVT-408</p>
	<p>T1 Classic S200L (N/S&gt;32 002) T1 Classic S200L (N/S&gt;202 000) T1 Line C200L (N/S&gt;68 381) T1 Line C200L (N/S&lt;302 000 y N/S&gt;202 000) T1 Line C200L (N/S&gt;302 000)</p> <p>T2 Line A200L (N/S&gt;202 000 y N/S&lt;302 000) T2 Line A200L (N/S&gt;302 000) T3 Line E200 (N/S&gt;202 000) T3 S-Line ES200 T2 S-Line AS200L</p> <p><b>Ref.: BVR-444</b> (Ref. Sirona®: 6414457 / 6562586)</p> <p><b>138<sup>00</sup>€</b></p>	<p><b>Cabeza standard</b></p> <p><b>Rodamientos:</b> 3,175x6x2mm</p> <p><b>Eje Ref.:</b> BVE-451 <b>Tapa Ref.:</b> BVT-410</p>
	<p>T1 Classic S200L mini (N/S&gt;30 000) T1 Line C200L mini (N/S&gt;65 000)</p> <p><b>Ref.: BVR-445</b> (Ref. Sirona®: 6405679)</p> <p><b>244<sup>80</sup>€</b></p>	<p><b>Cabeza mini</b></p> <p><b>Eje Ref.:</b> BVE-451 <b>Tapa Ref.:</b> BVT-410</p>
	<p>Dentsply X-Smart Plus 6:1</p> <p><b>Ref.: BVR-431</b></p> <p><b>88<sup>00</sup>€</b></p>	<p><b>Eje Ref.:</b> BVE-432 <b>Tapa Ref.:</b> BVT-433</p>
	<p>Dentsply X-Smart 16:1</p> <p><b>Ref.: BVR-434</b></p> <p><b>68<sup>80</sup>€</b></p>	<p><b>Eje Ref.:</b> BVE-435 <b>Tapa Ref.:</b> BVT-436</p>
	<p>T2 Revo Mini R40 T2 S-Line AS40L T3 S-Line ES40 T3 Line E40 (SN&gt;202 000) cabeza mini</p> <p>T2 Line A40 (SN&gt;202 000) T1 Classic S40L (SN&gt;30 000 &amp; &gt;202 000) T1 Line C40L (SN&gt;65 000 &amp; &gt;202 000)</p> <p>T1 Line C40/C40L 1:1 8,7 cabeza mini</p> <p><b>Ref.: BVR-416</b> (Ref. Sirona®: 6049352 / 6405695)</p> <p><b>98<sup>00</sup>€</b></p>	<p><b>Rodamiento trasero:</b> 4x7x1,6mm</p> <p><b>Eje R40 Ref.:</b> BVE-421 <b>Eje A40 Ref.:</b> BVE-418 <b>Eje C40 mini Ref.:</b> BVE-418 <b>Eje E40 mini Ref.:</b> BVE-418 <b>Tapa Ref.:</b> BVT-411</p>
	<p>T2 Revo Mini R40 T2 S-Line AS40L T3 S-Line ES40 T3 Line E40 (SN&gt;202 000) cabeza mini</p> <p>T2 Line A40 (SN&gt;202 000) T1 Classic S40L (SN&gt;30 000 &amp; &gt;202 000) T1 Line C40L (SN&gt;65 000 &amp; &gt;202 000)</p> <p>T1 Line C40/C40L 1:1 8,7 cabeza mini</p> <p><b>Ref.: BVR-452</b> (Ref. Sirona®: 5943092 / 6049352)</p> <p><b>98<sup>00</sup>€</b></p>	<p><b>Rodamiento trasero:</b> 4x7x2mm</p> <p><b>Eje R40 Ref.:</b> BVE-421 <b>Eje A40 Ref.:</b> BVE-418 <b>Eje C40 mini Ref.:</b> BVE-418 <b>Eje E40 mini Ref.:</b> BVE-418 <b>Tapa Ref.:</b> BVT-411</p>

SI NO ENCUENTRAS EL REPUESTO QUE BUSCAS, ¡CONSÚLTANOS!  
Precios: impuestos, portes y mano de obra no incluidos.

RUMAR

## Modelos para Sirona®

## Descripción



T1 Line Endo 6L

Eje Ref.: BVE-470  
Tapa Ref.: BVT-471Ref.: **BVR-469** (Ref. Sirona®: 6535525 / 6000777)84<sup>00</sup>€

## Ejes compatibles contra ángulos Sirona®

RUMAR

## Modelos para Sirona®

## Relacionados



T1 CLASSIC S200L mini  
T1 LINE C200L mini  
SN > 65 000 / SN > 43 000  
T1 LINE C200 mini  
SN > 30 000  
T2 LINE A200L  
SN<7804 / SN>7805  
T3 LINE E200  
SN<2325 / SN>2326  
T1 LINE C200  
SN>30 000  
T1 LINE C200L  
SN>43 000 / SN>65 00

T1 CLASSIC S200L  
SN≤32 001  
T1 CLASSIC S200L  
SN>32 002  
T1 CLASSIC S200L  
SN>202 000  
T1 LINE C200L  
SN>68 381  
T1 LINE C200L  
SN<302 000 & >202 000  
T1 LINE C200L  
SN>302 000 T2 line A200 L SN >202 000 & < 302 000

T2 S-line AS 200 L  
T3 S-line ES 200  
T3 line E200  
SN > 202 000  
T2 line A200 L  
SN > 302 000

Ref.: **BVE-451** (Ref. Sirona®: 6175603)149<sup>00</sup>€

T1 Classic S40  
T1 Line C40 (Cabeza mini y standard)  
T1 Line C40L (Cabeza mini y standard)

T2 Line A40  
T2 Line A40L  
T3 Line E40 (Cabeza mini y standard)

Ref.: **BVE-418** (Ref. Sirona®: 6000959)68<sup>00</sup>€

T1 CLASSIC KM 1,6L  
N/S > 30.000  
T1 CLASSIC S 1,6L  
N/S > 30.000 y N/S > 202.000  
T1 CLASSIC S 6L  
N/S > 30.000 y N/S > 202.000  
T1 LINE C1,6 (cabeza 6:1)  
T1 LINE C1,6C (cabeza 1:1 ADA)  
T1 LINE C1,6L (cabeza 1:1 ADA)  
T1 LINE C1,6L  
N/S > 65.000 y N/S > 202.000  
T1 LINE C1,6L (cabeza 6:1)  
T1 LINE C6 (cabeza 6:1)

T1 LINE C6 (cabeza 1:1 ADA)  
T1 LINE C6L (cabeza 6:1)  
T1 LINE C6L (cabeza 1:1 ADA)  
T1 LINE C6L  
N/S > 65.000 y N/S > 202.000  
T1 LINE KM 1,6  
T1 LINE KM 1,6L  
T2 LINE A 6L  
T2 LINE A 6L  
N/S > 202.000  
T2 S-LINE AS 6L  
T3 LINE E6

T3 S-LINE ES 6  
SIROPure P6 IL (cabeza 6:1 / 6:1 ADA)  
SIROPure P6 IL mini  
SIROPure P6 SL (cabeza 6:1 / 6:1 ADA)  
SIROPure P6 SL mini  
SIROPure T3 LINE E 6  
N/S > 202.000

Ref.: **BVE-452** (Ref. Sirona®: 6000942 / 3327884)228<sup>00</sup>€

T2 Revo R40

Ref.: **BVE-421** (Ref. Sirona®: 5943167)68<sup>00</sup>€

Dentsply X-Smart Plus 6:1

Ref.: **BVE-432**78<sup>00</sup>€

Dentsply X-Smart 16:1

Ref.: **BVE-435**68<sup>00</sup>€

## Modelos para Sirona®

## Relacionados



T1 Line ENDO 6L

Ref.: **BVE-470** (Ref. Sirona®: 6535533)**68<sup>00</sup>€**

## Tapas compatibles contra ángulos Sirona®

RUMAR

## Modelos para Sirona®

## Relacionados

T1 Classic S200L (SN≤32 001)  
T1 Line C200L  
(SN>43 000 & >65 000)  
T1 Line C200 (SN>30 000)T3 Line E200L  
T2 Line A200L  
(SN<7804 & >7805)  
T2 Line A170LT3 Line E200  
(SN<2325 & >2326)  
SIROPure P200SL  
SIROPure P200IL

Llave Ref.: HE-818

Ref.: **BVT-407** (Ref. Sirona®: 8925083 + 5996967 + 5947957)**24<sup>80</sup>€**T2 Line A40L  
T2 Line A6L  
T3 Line E40T3 Line E6  
SIROPure P40SL (ADA)  
SIROPure P40IL (ADA)SIROPure P6SL (ADA)  
SIROPure P6SIL (ADA)

Llave Ref.: HE-818

Ref.: **BVT-409** (Ref. Sirona®: 8925083 + 8917924 + 5947957)**56<sup>80</sup>€**T1 Classic S40L  
T1 Classic S6L  
T1 Line C40 (ADA)  
T1 Line C40L (ADA)T1 Line C6  
T1 Line C6L  
T1 Line C16  
T1 Line C16LSiropure P40SL  
Siropure P40IL  
Siropure P6SL  
Siropure P6IL

Llave Ref.: HE-818

Ref.: **BVT-408** (Ref. Sirona®: 8925083 + 6259639 + 5947957)**24<sup>80</sup>€**T1 Classic S200L (SN≥32 002)  
T1 Classic S200L  
T1 Classic S200L mini  
T1 Line C200L  
(SN>68 381 & <43 000)T1 Line C200L  
(SN<302 000 & >302 000)  
T1 Line C200L mini  
T2 Line A200  
(SN<302 000 & >302 000)T2 S-Line AS200L  
T3 S-LINE ES200  
SIROPure P200SL  
SIROPure P200IL  
T3 LINE E200

Llave Ref.: HE-821

Ref.: **BVT-410** (Ref. Sirona®: 6049337)**24<sup>80</sup>€**T1 Classic S40L  
T1 Classic S6L  
T1 Classic S1,6L  
T1 Classic S40L (SN>202 000)  
T1 Classic S6L (SN>202 000)  
T1 Classic S1,6L (SN>202 000)  
T1 Classic C40L (SN>65 000)  
T1 Classic C6L (SN>65 000)  
T1 Classic C1,6L (SN>65 000)  
T1 Classic C40L (SN>202 000)  
T1 Classic C6L (SN>202 000)  
T1 Line C40  
T1 Line C40 miniT1 Line C40L  
T1 Line C40L mini  
T1 Line C6  
T1 Line C6L mini  
T1 Line C16  
T1 Line C1,6L  
T2 S-Line AS40L  
T2 S-Line AS6L  
T3 S-Line ES40  
T3 S-Line ES6  
SIROPure P40SL  
SIROPure P40IL  
SIROPure P6SLSIROPure P6IL  
T2 Line A6L (SN>202 000)  
T2 Line A40L (SN>202 000)  
T3 Line E40 (SN>202 000)  
T3 Line E6 (SN>202 000)  
T1 Line C1,6L (SN >202 000)

Llave Ref.: HE-821

Ref.: **BVT-411** (Ref. Sirona®: 6049329)**24<sup>80</sup>€**

Dentsply X-Smart Plus 6:1

Ref.: **BVT-433****29<sup>80</sup>€**

Llave Ref.: HE-610



Dentsply X-Smart 16:1

Ref.: **BVT-436****24<sup>80</sup>€**

Llave Ref.: HE-845

## Modelos para Sirona®

## Relacionados



TI Line ENDO 6L

Llave Ref.: HE-821

Ref.: **BVT-471** (Ref. Sirona®: 65444444)19<sup>80</sup>€

## Resto repuestos contra ángulos Sirona®

RUMAR

## Descripción

## Observaciones

Tubo irrigación azul contra ángulos y piezas de mano Sirona®  
\*\*\*Original Sirona\*\*\*

Pack: 2 Uds.

Ref.: **BVX-8236** (Ref. 6328236 / 25)5<sup>30</sup>€

NUEVO

REPUESTOS PARA CONTRA ÁNGULOS  
Y PIEZAS DE MANO MK-DENT®

## Rotores contra ángulos MK-dent®



## Modelos para MK-dent®

## Relacionados

LCH11  
LPH11  
LS9011Ref.: **BVR-SP2005**121<sup>80</sup>€

## Ejes contra ángulos MK-dent®

RUMAR

## Modelos para MK-dent®

## Relacionados

LCH11  
LPH11  
LS9011  
LS9016Ref.: **BVE-724** (Ref. MK-dent®: SP2024)48<sup>00</sup>€

Imagen no disponible

LE11  
LET1L  
LS2011  
LS2011LRef.: **BVE-1010**38<sup>00</sup>€

Imagen no disponible

LE15  
LE15LRef.: **BVE-SP2246M1**148<sup>00</sup>€

HASTA AGOTAR





## Tapas contra ángulos MK-dent®

RUMAR

Modelos para MK-dent®		Relacionados
	3 muescas LCH11 LCH21 LS9011  LS9021	Llave doble Ref.: HE-751 *Tapa original (4 lados) Llave Ref.: HE-2011T
	Ref.: <b>BVT-704</b> (Ref. MK-dent®: 0.540.3741)	25'80€
	LCH16	Llave Ref.: HE-620
	Ref.: <b>BVT-BC9016</b>	44'80€
		HASTA AGOTAR

## Anillos Tóricos Contra Ángulos y Piezas de Mano MK-dent®

RUMAR















Modelos para MK-dent®	
	LC01 LC01L LC11 LC11L LE11 (N/S: Consultar) LE11L (N/S: Consultar) LP01L LP11L LS2011 LS2011L LS1011
	Ref.: <b>OR-1020</b> (Ref. MK-dent® SP1020)
	1'80€
	LE11 (N/S: Consultar) LE11L (N/S: Consultar)
	Ref.: <b>OR-1514</b> (Ref. MK-dent® SP1514)
	1'80€



NUEVO

## Resto repuestos contra ángulos MK-dent®

RUMAR











Descripción	Observaciones
 Carcasa LCH11 y LS9011 Ref.: <b>BVX-706</b> (Ref. MK-dent®: SP2001)	54'80€
 Carcasa LCH21 y LS9021 Ref.: <b>BVX-2101</b>	63'80€
 Carcasa LS9016 Ref.: <b>BVX-2221</b> (Ref. MK-dent®: SP2221)	58'00€ HASTA AGOTAR
 Segmento LCH11, LCH21, LPH11, LPH21, LS9011 y LS9021 Ref.: <b>BVX-702</b> (Ref. MK-dent®: SP2004)	7'80€
 Chaveta LCH11, LCH21, LPH11, LPH21, LS9011 y LS9021 Ref.: <b>BVX-703</b> (Ref. MK-dent®: SP2006)	12'80€
 Anillo de conducción LCH11, LCH21, LPH11, LPH21, LS9011 y LS9021 Ref.: <b>BVX-707</b> (Ref. MK-dent®: SP2007)	1'80€ Útil Ref.: HE-752

	Descripción	Observaciones
	Muelle LCH11, LCH21, LPH11, LPH21, LS9011 y LS9021 <b>Ref.: BVX-709</b> (Ref. MK-dent®: SP2023)	2´70.€
	Muelle para LS2011 y LS2011L <b>Ref.: BVX-1004</b> (Ref. MK-dent®: SP1004)	1´30.€ <b>HASTA AGOTAR</b>
	Muelle de presión para LS2011 y LS2011L <b>Ref.: BVX-1014</b> (Ref. MK-dent®: SP1014)	0´90.€
	Tornillo LCH11, LCH21, LPH11, LPH21, LS9011 y LS9021 <b>Ref.: BVX-708</b> (Ref. MK-dent®: SP2021)	Destornillador: HE-2016, HE-753TOR. 1´90.€
	Anillo azul para: LE11, LE11L, LC11, LC11L y LP11L <b>Ref.: BVX-0031</b> (Ref. MK-dent®: SP0031)	3´40.€
	Anillo de cierre para LS2011 y LS2011L (NO válido para líneas LE, LC o LP) <b>Ref.: BVX-1003</b> (Ref. MK-dent®: SP1003)	26´40.€ <b>HASTA AGOTAR</b>
	Anillo de alambre para LE11, LE11L, LC11, LC11L, LP11L, LS2011 y LS2011L <b>Ref.: BVX-1005</b> (Ref. MK-dent®: SP1005)	1´00.€
	Bola para LE11, LE11L, LC11, LC11L, LP11L, LS2011 y LS2011L <b>Ref.: BVX-1006</b> (Ref. MK-dent®: SP1006)	3,0 mm 0´80.€
	Bola para LE11, LE11L, LC11, LC11L, LP11L, LS2011 y LS2011L <b>Ref.: BVX-1007</b> (Ref. MK-dent®: SP1007)	1,5 mm 0´80.€ <b>HASTA AGOTAR</b>
	Distanciador para LE11, LE11L, LC11, LC11L, LP11L, LS2011 y LS2011L <b>Ref.: BVX-1012</b> (Ref. MK-dent®: SP1012)	4´70.€ <b>HASTA AGOTAR</b>
	Tope arrastre trasero para LE11, LE11L, LC11, LC11L, LP11L, LS2011 y LS2011L <b>Ref.: BVX-1016</b> (Ref. MK-dent®: SP1016)	30´80.€
	Pasador para tope de arrastre para LE11, LE11L, LC11, LC11L, LP11L, LS2011 y LS2011L <b>Ref.: BVX-1017</b> (Ref. MK-dent®: SP1017)	1´10.€
	Inserto LS2011 (NO válido para líneas LE, LC o LP) <b>Ref.: BVX-1019</b> (Ref. MK-dent®: SP1019)	65´90.€ <b>HASTA AGOTAR</b>
	Inserto LS2011L (NO válido para líneas LE, LC o LP) <b>Ref.: BVX-1019L</b> (Ref. MK-dent®: SP1019L)	65´90.€ <b>HASTA AGOTAR</b>

	Descripción	Observaciones
	Guía posicionamiento LS2011L (NO válido para líneas LE, LC o LP)  <b>Ref.: BVX-1023</b> (Ref. MK-dent®: SP1023)	19´60€ <span style="float: right;">HASTA AGOTAR</span>
	Barra transmisión luz LE11L, LC11L y LP11L  <b>Ref.: BVX-9002</b> (Ref. MK-dent®: SP9002)	108´00€

## Repuestos piezas de mano MK-dent®

RUMAR



	Descripción	Observaciones
	Anillo azul para LE01, LE01L, LC01, LC01L y LP01L  <b>Ref.: BVX-0031</b> (Ref. MK-dent®: SP0031)	3´40€
	Eje completo para LE01, LE01L, LC01, LC01L y LP01L  <b>Ref.: BVX-1138</b> (Ref. MK-dent®: SP1138)	224´80€
	Anillo cierre para LS1011  <b>Ref.: BVX-1039</b> (Ref. MK-dent®: SP1039)	55´80€
	Cartucho para rodamiento para LS1011  <b>Ref.: BVX-1040</b> (Ref. MK-dent®: SP1040)	48´20€ <span style="float: right;">HASTA AGOTAR</span>
	Anillo para LS1011  <b>Ref.: BVX-1041</b> (Ref. MK-dent®: SP1041)	8´00€ <span style="float: right;">HASTA AGOTAR</span>
	Perno para LS1011  <b>Ref.: BVX-1042</b> (Ref. MK-dent®: SP1042)	5´50€ <span style="float: right;">HASTA AGOTAR</span>
	Anillo roscado para LS1011  <b>Ref.: BVX-1043</b> (Ref. MK-dent®: SP1043)	6´90€ <span style="float: right;">HASTA AGOTAR</span>
	Arandela para LS1011  <b>Ref.: BVX-1044</b> (Ref. MK-dent®: SP1044)	4´40€ <span style="float: right;">HASTA AGOTAR</span>
	Tornillo para LS1011  <b>Ref.: BVX-1045</b> (Ref. MK-dent®: SP1045)	1´40€ <span style="float: right;">HASTA AGOTAR</span>
	Inserto para LS1011  <b>Ref.: BVX-1046</b> (Ref. MK-dent®: SP1046)	64´20€ <span style="float: right;">HASTA AGOTAR</span>
	Clip para LS1011  <b>Ref.: BVX-1047</b> (Ref. MK-dent®: SP1047)	1´90€ <span style="float: right;">HASTA AGOTAR</span>

	Descripción	Observaciones
	<p>Tope arrastre trasero para LSI011</p> <p>Ref.: <b>BVX-1016</b> (Ref. MK-dent®: SP1016)</p> <p><b>30<sup>80</sup>€</b></p>	
	<p>Pasador para tope arrastre para LSI011</p> <p>Ref.: <b>BVX-1017</b> (Ref. MK-dent®: SP1017)</p> <p><b>1<sup>50</sup>€</b></p>	

## REPUESTOS PARA CONTRA ÁNGULOS Y PIEZAS DE MANO CASTELLINI®

### Rotores compatibles contra ángulos Castellini®

RUMAR

	Modelos para Castellini®	Relacionados
	<p>Goldspeed EVO S1</p> <p>Ref.: <b>BVR-483</b></p> <p><b>178<sup>80</sup>€</b></p>	<p>Tapa Ref.: BVT-485</p> <p><b>BAJO PEDIDO</b></p>
	<p>Goldspeed S1 Goldspeed SIL</p> <p>Ref.: <b>BVR-380</b></p> <p><b>68<sup>80</sup>€</b></p>	<p>Eje Ref.: BVE-396 Tapa Ref.: BVT-484</p>



### Ejes compatibles contra ángulos Castellini®

RUMAR

	Modelos para Castellini®	Relacionados
	<p>Goldspeed S1 Goldspeed SIL</p> <p>Ref.: <b>BVE-396</b></p> <p><b>48<sup>00</sup>€</b></p>	

### Tapas compatibles contra ángulos Castellini®

RUMAR

	Modelos para Castellini®	Relacionados
	<p>Goldspeed S1 Goldspeed SIL (Excepto Goldspeed <b>EVO</b> S1 y Goldspeed <b>EVO</b> S1-L)</p> <p>Ref.: <b>BVT-485</b></p> <p><b>42<sup>80</sup>€</b></p>	<p>Llave Ref.: HE-833</p>
 <small>Imagen no disponible</small>	<p>Goldspeed <b>EVO</b> S1</p> <p>Ref.: <b>BVT-484</b></p> <p><b>68<sup>00</sup>€</b></p>	<p>Llave Ref.: HE-834</p>

## REPUESTOS PARA CONTRA ÁNGULOS Y PIEZAS DE MANO BA INTERNACIONAL®

### Rotores compatibles contra ángulos BA International®

RUMAR

	Modelos para BA International®	Relacionados
	B.A40LSS B.A40SS B.A45LS  B.A45SS	Eje Ref.: BVE-421
	Ref.: BVR-417	98 <sup>00</sup> €

### Ejes compatibles contra ángulos BA International®

RUMAR

	Modelos para BA International®	Relacionados
	BA45S BA40LSS BA40SS  BA45LS	
	Ref.: BVE-421	68 <sup>00</sup> €

## REPUESTOS PARA CONTRA ÁNGULOS Y PIEZAS DE MANO WOODPECKER® / DTE®



### Rotores contra ángulos WOODPECKER® / DTE®



	Modelos para WOODPECKER® / DTE®	Relacionados
	Kit rotor + tapa + arandela WP-1 WP-1L* (IMPLANTER LED / DTE IMPLANT X LED) <b>*Contra ángulos con uno y dos tornillos</b>	Eje Ref. WP-1L: 28-CA002 Tapa Ref.: 28-CA003  Eje Ref. WP-1: 28-CA008 Suministro incluye: Tapa, rotor y arandela.
	Ref.: 28-CA001	168 <sup>00</sup> €

### Ejes contra ángulos WOODPECKER® / DTE®



	Modelos para WOODPECKER® / DTE®	Relacionados
	WP-1L (IMPLANTER LED / DTE IMPLANT X LED) <b>*Contra ángulos con uno y dos tornillos*</b>	
	Ref.: 28-CA002	102 <sup>80</sup> €
 Imagen no disponible	WP-1	Llave Ref.: 28-CA006
	Ref.: 28-CA008	102 <sup>80</sup> €

## ▶ Tapas contra ángulos **Woodpecker® / DTE®**



### Modelos para WOODPECKER® / DTE®

### Relacionados



	<p>WP-1 WP-1L* (IMPLANTER LED / DTE® IMPLANT X LED) <b>*Contra ángulos con uno y dos tornillos</b></p> <p><b>Ref.: 28-CA003</b></p>	<p><b>Rotor Ref.: 28-CA001</b> <b>Llave Ref.: 28-CA005</b></p>
	<b>29<sup>´</sup>80.€</b>	

## ▶ Resto repuestos contra ángulos **Woodpecker® / DTE®**



### Descripción

### Observaciones

	<p>Carcasa cabeza WP-1L contra ángulos con dos tornillos</p> <p><b>Ref.: 28-CA007</b></p>	
	<b>80<sup>´</sup>00.€</b>	
 <small>Imagen no disponible</small>	<p>Carcasa cabeza WP-1</p> <p><b>Ref.: 28-CA009</b></p>	
	<b>50<sup>´</sup>80.€</b>	



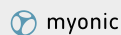





Todos los rodamientos que ofrecemos están fabricados por los principales fabricantes de rodamientos a nivel mundial: **myonic**, **HQW-Barden**, **GRW**, **NMB**, **EZO** o **ESC**. Todos fabricados de acuerdo a las normas de precisión ISO\* (normas para rodamientos de dimensiones métricas) y ABEC\*\* (rodamientos generalmente en dimensiones de pulgadas).











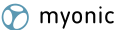

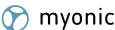

## RODAMIENTOS PARA CONTRA ÁNGULOS Y PIEZAS DE MANO KAVO®

### Rodamientos contra ángulos KaVo®

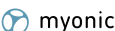

RUMAR

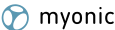
Modelos para KaVo®			Descripción
 myonic	Delantero cabeza 67LH Delantero cabeza 68LH Delantero cabeza 2068CHC	Delantero cabeza 2068LHC Delantero cabeza L68 Delantero cabeza L67	Delantero cabeza C3  <b>Medidas:</b> 3x7x2,5/3,35mm <b>Especial</b> Exterior: Liso Bola: Acero Retenedor: Torlon Abierto-Cerrado
 myonic	Trasero cabeza 67LH Trasero cabeza 68 LH Trasero cabeza 2068CHC	Trasero cabeza 2068LHC Trasero cabeza L68 Trasero cabeza L67	<b>Medidas:</b> 4x7x2mm Exterior: Liso Bola: Acero Retenedor: Acero Cerrado-Cerrado
 myonic	Delantero cabeza 67LDN Delantero cabeza 68LDN Delantero cabeza 67RIC		<b>Medidas:</b> 3x7x3mm Exterior: Liso Bola: Acero Retenedor: Acero Cerrado-Cerrado
 myonic	Trasero cabeza 67LDN Trasero cabeza 68LDN		<b>Medidas:</b> 4x7x2mm Exterior: Liso Bola: Acero Retenedor: Acero Abierto-Abierto
 HQW BARDEN	Trasero cabeza 67RIC Trasero cabeza C3		<b>Medidas:</b> 5x8x2mm Exterior: Liso Bola: Acero Retenedor: Acero Cerrado-Cerrado
 myonic	Cabeza 31LR Cabeza 52LDN Cabeza 67IC	Cabeza 68G	<b>Medidas:</b> 3x6x2mm Exterior: Liso Bola: Acero Retenedor: Acero Cerrado-Cerrado
 myonic	20CN 20LN 20CH	20LH 2068CHC 2068LHC	2068C E20 E20L  <b>Medidas:</b> 3x8x3mm Exterior: Liso Bola: Acero Retenedor: Acero Cerrado-Cerrado
 myonic	Cabeza 24LN		<b>Medidas:</b> 4x7x2mm Exterior: Liso Bola: Cerámica Retenedor: Torlon Abierto-Cerrado





Modelos para KaVo®			Observaciones
	25CH 25CHC 25CN 25LH	25LHS 25LN 25LS 25LHC	25LHD Trasero 25LP
	<b>Ref.: ROD-325</b> (Ref. KaVo®: 1.001.2836 / 0.220.1307)		<b>33<sup>80</sup>€</b> <b>Medidas:</b> 4x7x2mm <b>Especial</b> Exterior: Liso Bola: Cerámica Retenedor: Torlon Abierto-Cerrado
	Delantero cabeza 25LP Delantero cabeza 25LPA		
	<b>Ref.: ROD-317</b> (Ref. KaVo®: 1.001.3167)		<b>30<sup>80</sup>€</b> <b>Medidas:</b> 3,175x6,35x2,778mm <b>Especial</b> Exterior: Liso Bola: Cerámica Retenedor: Torlon Abierto-Abierto
	Delantero cabeza E25L Delantero cabeza E25C		
	<b>Ref.: ROD-320</b> (Ref. KaVo®: 1.008.4038)		<b>30<sup>80</sup>€</b> <b>Medidas:</b> 3,175x6,35x2,778mm <b>Especial</b> Exterior: Liso Bola: Cerámica Retenedor: Torlon Abierto-Abierto
	Trasero cabeza E25L Trasero cabeza E25C		
	<b>Ref.: ROD-321</b> (Ref. KaVo®: 1.008.4039)		<b>30<sup>80</sup>€</b> <b>Medidas:</b> 3,175x6,35x2,778mm <b>Especial</b> Exterior: Liso Bola: Cerámica Retenedor: Torlon Abierto-Cerrado
	Eje 25LP Eje 25LPA Acoplador 25LP	Acoplador 25LPA Trasero eje E25L Trasero eje E25C	
	<b>Ref.: ROD-322</b> (Ref. KaVo®: 1.001.2834)		<b>19<sup>80</sup>€</b> <b>Medidas:</b> 2x5x1,5mm Exterior: Liso Bola: Acero Retenedor: Torlon Abierto-Abierto
	Acoplador E25L Acoplador E25C Acoplador 25LH Acoplador 25CH	Acoplador 25CHC Acoplador 25CN Acoplador 25LHS Acoplador 25LN	Acoplador 25LS Acoplador 25LHC Acoplador 25LHD
	<b>Ref.: ROD-323</b> (Ref. KaVo®: 0.220.0171)		<b>16<sup>80</sup>€</b> <b>Medidas:</b> 4x9x2,5mm <b>Especial</b> Exterior: Liso Bola: Acero Retenedor: Acero Abierto-Abierto
	Eje 25LH Eje 25CH Eje 25CHC Eje 25CN Eje 25LH Eje 25LHS Eje 25LN Eje 25LS Eje 25LHC Eje 25LHD	Engranaje Intermedio 25LH Engranaje Intermedio 25CH Engranaje Intermedio 25CHC Engranaje Intermedio 25CN Engranaje Intermedio 25LH Engranaje Intermedio 25LHS Engranaje Intermedio 25LN Engranaje Intermedio 25LS Engranaje Intermedio 25LHC Engranaje Intermedio 25LHD	Delantero eje E25L Delantero eje E25C
	<b>Ref.: ROD-324</b> (Ref. KaVo®: 0.220.0730)		<b>24<sup>80</sup>€</b> <b>Medidas:</b> 2,35x5x1,5mm Exterior: Liso Bola: Acero Retenedor: Torlon Abierto-Abierto

## Rodamientos piezas de mano KaVo®

RUMAR

Modelos para KaVo®		Descripción
	Trasero 10A (NO 10C)	
	<b>Ref.: ROD-5014</b> (Ref. KaVo®: 0.220.0103)	<b>16<sup>60</sup>€</b> <b>Medidas:</b> 4x9x4mm Exterior: Liso Bola: Acero Retenedor: Acero Cerrado-Cerrado



Modelos para KaVo®		Observaciones
 myonic	Trasero 10C  <b>Ref.: ROD-200</b> (Ref. KaVo®: 0.220.0126)	<b>Medidas:</b> 5x11x5mm Exterior: Liso Bola: Acero Retenedor: Acero Cerrado-Cerrado  <b>12'80€</b>
 myonic	Delantero 10CH Delantero 10LC Delantero 10CHC  Delantero 10CN Delantero 10LN 10C (Confirmar alto previamente)	<b>Medidas:</b> 5x8x3mm Exterior: Liso Bola: Acero Retenedor: Acero Cerrado-Cerrado  <b>16'80€</b>
 myonic	Delantero 15CN Series  <b>Ref.: ROD-303</b> (Ref. KaVo®: 0.220.1306)	<b>Medidas:</b> 5x9,525x3,175mm <b>Especial</b> Exterior: Liso Bola: Acero Retenedor: Bronce Cerrado-Cerrado  <b>42'80€</b>
 myonic	Trasero 15CN Series Trasero 10CN Trasero 10LN  Trasero 10CH Trasero 10LC Trasero 10CHC	<b>Medidas:</b> 4x9x4mm <b>Especial</b> Exterior: Liso Bola: Acero Retenedor: Acero Cerrado-Cerrado  <b>31'80€</b>

## RODAMIENTOS PARA CONTRA ÁNGULOS Y PIEZAS DE MANO NSK®

### Rodamientos contra ángulos NSK®





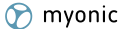

RUMAR

Modelos para NSK®		Descripción
 myonic	Cabeza T125 Cabeza X95 Cabeza X95L  Cabeza X85 Cabeza X85L  <b>Ref.: ROD-326</b>	<b>Medidas:</b> 4x7x2mm <b>Especial</b> Exterior: Liso Bola: Cerámica Retenedor: Tórlon Abierto-Abierto  <b>29'80€</b>
 myonic	Delantero Ti-Max X-SG20L Delantero Ti-Max X-DSG20L Delantero S-Max SG20 Delantero S-Max SG20L  <b>Ref.: ROD-309</b>	<b>Medidas:</b> 4x7x2mm <b>Especial</b> Exterior: Liso Bola: Acero Sin retenedor Abierto-Cerrado  <b>32'80€</b>
 HAW BARDEN	Trasero Ti-Max X-SG20L Trasero Ti-Max X-DSG20L Trasero S-Max SG20 Trasero S-Max SG20L  <b>Ref.: ROD-318</b>	<b>Medidas:</b> 5x8x2mm Exterior: Liso Bola: Acero Retenedor: Acero Cerrado-Cerrado  <b>16'80€</b>
 HAW BARDEN	Eje SG20  <b>Ref.: ROD-306</b>	<b>Medidas:</b> 2,35x5,5x2mm Exterior: Liso Bola: Acero Retenedor: Acero Abierto-Abierto  <b>13'80€</b>

Modelos para NSK®		Observaciones
 	Eje SG20  <b>Ref.: ROD-308</b>	<b>Medidas:</b> 2,35x5,5x2mm Exterior: Liso Bola: Acero Retenedor: Torlon Abierto-Abierto
		<b>19´80€</b>

## Rodamientos piezas de mano NSK®





RUMAR

Modelos para NSK®		Descripción
 	Trasero EX5                      Trasero EX9 Trasero EX6                      Trasero EX12 Trasero EX7                      Trasero IS65 Trasero EX8  <b>Ref.: ROD-313</b> (Ref. NSK®: B10321-1005)	<b>Medidas:</b> 5x10x3mm Exterior: Liso Bola: Acero Retenedor: Acero Abierto-Abierto
		<b>9´80€</b>
 	Trasero X65 Trasero X65L  <b>Ref.: ROD-328</b> (Ref. NSK®: B11223-1005)	<b>Medidas:</b> 5x10x4mm Exterior: Liso Bola: Acero Retenedor: TN9 Sintético Cerrado-Cerrado
		<b>10´20€</b>
 	Delantero EX5                      Delantero EX9 Delantero EX6                      Delantero EX12 Delantero EX7                      Delantero IS65 Delantero EX8  <b>Ref.: ROD-314</b> (Ref. NSK®: B13213-0804)	<b>Medidas:</b> 4x8x3mm Exterior: Liso Bola: Acero Retenedor: Acero Cerrado-Cerrado
		<b>10´20€</b>

## RODAMIENTOS PARA CONTRA ÁNGULOS Y PIEZAS DE MANO W&H®









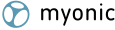

### Rodamientos contra ángulos W&H®

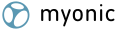
RUMAR

Modelos para W&H®		Descripción
 	Cabeza WA-56LT nuevo Cabeza WA-56A nuevo  <b>Ref.: ROD-300</b> (Ref. W&H®: 05039400)	<b>Medidas:</b> 4x7x1,6mm Exterior: Liso Bola: Acero Retenedor: Acero Abierto-Abierto
		<b>26´80€</b>
 	Cabeza WE99 LED-G Cabeza WE99A Cabeza WE99E  <b>Ref.: ROD-326</b> (Ref. W&H®: 02649400 / 04486000)	<b>Medidas:</b> 4x7x2mm <b>Especial</b> Exterior: Liso Bola: Cerámica Retenedor: Torlon Abierto-Abierto
		<b>29´80€</b>

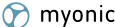

## Modelos para KaVo®

## Observaciones

 	<p>Cabeza WA-56LT Cabeza WA-56A Cabeza WA-66LT Cabeza WA-66A Cabeza WA-86LT Cabeza WA-86A Cabeza A956E Cabeza A956A Cabeza A956LT Cabeza A956LX Cabeza 966E Cabeza 966A Cabeza 966LT</p>	<p>Cabeza 966LX Cabeza 975E Cabeza 975A Cabeza 975LT Cabeza 975LX Cabeza 985E Cabeza 985A Cabeza 985LT Cabeza 985LX Cabeza 986E Cabeza 986A Cabeza 986LT Cabeza 986LX</p>	<p>Cabeza 988E Cabeza 988E-KM Cabeza WE-56 LED G Cabeza WS-75E Cabeza WS-75KM Friatec 90 Friatec 5040 Delantero y medio acople WS-75E Delantero y medio acople WS-75KM</p>	<p><b>Medidas:</b> 4x7x2mm Exterior: Liso Bola: Acero Retenedor: Acero Abierto-Abierto</p>
 	<p>Cabeza WS-75E Cabeza WS-75KM Cabeza WI75</p>			<p><b>Medidas:</b> 4x7x2mm <b>Especial</b> Exterior: Liso Bola: Acero Sin retenedor Abierto-Cerrado</p>
 	<p>Pieza intermedia WA-56LT Pieza intermedia WA-56A Pieza intermedia WA56LT nuevos Pieza intermedia WA-62LT Pieza intermedia WA-62A</p>	<p>Pieza intermedia WA-66LT Pieza intermedia WA-66A Pieza intermedia WA-67LT Pieza intermedia WA-67A Pieza intermedia WA-86LT</p>	<p>Pieza intermedia WA-86A Pieza intermedia WS-75E Pieza intermedia WS-75KM</p>	<p><b>Medidas:</b> 2,35x5,5x2mm Exterior: Liso Bola: Acero Retenedor: Acero Abierto-Abierto</p>
 	<p>Delantero eje WA-56LT Delantero eje WA-56A Delantero eje WA-62LT Delantero eje WA-62A Delantero eje WA-66LT Delantero eje WA-66A Delantero eje WA-67LT Delantero eje WA-67A</p>	<p>Delantero eje WA-86LT Delantero eje WA-86A nuevos y antiguos Delantero eje WD-56 Delantero eje WD-57 Delantero eje WD-58 Delantero eje WD-64 Delantero eje WD-66</p>	<p>Delantero eje WD-71 Delantero eje WD-72 Delantero eje WD-73 Delantero eje WD-74 Delantero eje HD-43 Delantero eje HP-44 Delantero eje WS-75E</p>	<p><b>Medidas:</b> 3x7x2mm Exterior: Liso Bola: Acero Retenedor: Acero Abierto-Abierto</p>
 	<p>Trasero eje WA-56LT Trasero eje WA-56A Trasero eje WA-62LT Trasero eje WA-62A Trasero eje WA-66LT Trasero eje WA-66A Trasero eje WA-67LT Trasero eje WA-67A</p>	<p>Trasero eje WA-86LT Trasero eje WA-86A nuevos y antiguos Trasero eje WD-56 Trasero eje WD-57 Trasero eje WD-58 Trasero eje WD-64 Trasero eje WD-66</p>	<p>Trasero eje WD-71 Trasero eje WD-72 Trasero eje WD-73 Trasero eje WD-74 Trasero eje HD-43 Trasero eje HP-44 Trasero eje WS-75E Trasero eje WS-75KM</p>	<p><b>Medidas:</b> 3x10x4mm Exterior: Liso Bola: Acero Retenedor: Acero Abierto-Abierto</p>
 	<p>Pieza intermedia WA-99 Pieza intermedia WA-969 Pieza intermedia WA-999</p>			<p><b>Medidas:</b> 2,35x5,5x2mm Exterior: Liso Bola: Acero Retenedor: Torlon Abierto-Abierto</p>

## Rodamientos piezas de mano W&amp;H®

RUMAR

Modelos para W&H®		Descripción
 	Trasero S11 Trasero Synea® HA43A  <b>Ref.: ROD-302</b>	<b>Medidas:</b> 3x10x4mm Exterior: Liso Bola: Acero Retenedor: Acero Abierto-Abierto
 myonic	Delantero WH S11 Delantero Synea® HA43A  <b>Ref.: ROD-7185</b>	<b>Medidas:</b> 5x8x3mm Exterior: Liso Bola: Acero Retenedor: Acero Cerrado-Cerrado

## RODAMIENTOS PARA CONTRA ÁNGULOS Y PIEZAS DE MANO BIEN AIR®

## Rodamientos contra ángulos Bien Air®

RUMAR

Modelos para Bien Air®		Descripción
  myonic	Cabeza 1132 Trasero cabeza Serie Microseries  <b>Ref.: ROD-301</b> (Ref. Bien Air®: 701.01.81)	<b>Medidas:</b> 4x7x2mm Exterior: Liso Bola: Acero Retenedor: Acero Abierto-Abierto
 	Delantero cabeza Serie Microseries  <b>Ref.: ROD-318</b>	<b>Medidas:</b> 5x8x2mm Exterior: Liso Bola: Acero Retenedor: Acero Cerrado-Cerrado
  myonic	Eje intermedio 1:1 Eje intermedio 1:4 Eje intermedio 1:5  <b>Ref.: ROD-315</b> (Ref. Bien Air®: 701.01.75)	<b>Medidas:</b> 2,35x4,763x2,35mm Exterior: Liso Bola: Acero Retenedor: Acero Cerrado-Cerrado

## Rodamientos piezas de mano Bien Air®





RUMAR

Modelos para Bien Air®		Descripción
 	Trasero 1:1 (Ref.: 160.03.83)  <b>Ref.: ROD-302</b> (Ref. Bien Air®: 701.01.65)	<b>Medidas:</b> 3x10x4mm Exterior: Liso Bola: Acero Retenedor: Acero Abierto-Abierto
  myonic	Delantero 1:1 (Ref.: 160.03.83)  <b>Ref.: ROD-7185</b> (Ref. Bien Air®: 701.01.53)	<b>Medidas:</b> 5x8x3mm Exterior: Liso Bola: Acero Retenedor: Acero Cerrado-Cerrado

# RODAMIENTOS PARA CONTRA ÁNGULOS Y PIEZAS DE MANO SIRONA®

## Rodamientos contra ángulos Sirona®



RUMAR



Modelos para Sirona®		Descripción
	Delantero cabeza T1 Line C40 Delantero cabeza T1 Line C40L  <b>Ref.: ROD-307</b>	<b>Medidas:</b> 3x7x2mm Exterior: Liso Bola: Acero Retenedor: Acero Abierto-Abierto  <b>12´80€</b>
	Trasero cabeza T1 Line C40 Trasero cabeza T1 Line C40L  <b>Ref.: ROD-309</b>	<b>Medidas:</b> 4x7x2mm <b>Especial</b> Exterior: Liso Bola: Acero Sin retenedor Abierto-Cerrado  <b>32´80€</b>
	Delantero T2 REVO  <b>Ref.: ROD-305</b>	<b>Medidas:</b> 3x6x2mm Exterior: Liso Bola: Acero Retenedor: Acero Cerrado-Cerrado  <b>13´30€</b>
	Trasero T2 REVO  <b>Ref.: ROD-300</b>	<b>Medidas:</b> 4x7x1,6mm Exterior: Liso Bola: Acero Retenedor: Acero Abierto-Abierto  <b>26´30€</b>
	T1 Line C200 mini T1 Classic S200 mini  <b>Ref.: ROD-353</b>	<b>Medidas:</b> 3,175x6x2mm Exterior: Liso Bola: Acero Retenedor: Acero Abierto-Abierto

# RODAMIENTOS PARA CONTRA ÁNGULOS Y PIEZAS DE MANO MK-DEnt®

## Rodamientos contra ángulos MK-dent®





RUMAR

Modelos para MK-dent®		Descripción
	Delantero cabeza LS9011 Delantero cabeza LS9021 Delantero cabeza LCH11 Delantero cabeza LCH21 Delantero cabeza LPH11 Delantero cabeza LPH21  <b>Ref.: ROD-5011</b>	<b>Medidas:</b> 3x7x2,5/3,35mm <b>Especial</b> Exterior: Liso Bola: Acero Retenedor: Tornón Abierto-Cerrado  <b>18´90€</b>
	Trasero cabeza LS9011 Trasero cabeza LS9021 Trasero cabeza LCH11 Trasero cabeza LCH21 Trasero cabeza LPH11 Trasero cabeza LPH21  <b>Ref.: ROD-5012</b>	<b>Medidas:</b> 4x7x2mm Exterior: Liso Bola: Acero Retenedor: Acero Cerrado-Cerrado  <b>16´10€</b>

Modelos para MK-dent®			Descripción
 	LC11 LC11L LE11	LE11L LP11L LS2011	LS2011L LS3011 LS3011L
	<b>Ref.: ROD-0218</b>		<b>11'80€</b> <b>Medidas:</b> 3x8x3mm Exterior: Liso Bola: Acero Retenedor: Acero Cerrado-Cerrado

### Rodamientos piezas de mano MK-dent®





RUMAR

Modelos para MK-dent®			Descripción
 	Trasero LC01 Trasero LC01L	Trasero LE01 Trasero LE01L	Trasero LP01L Trasero LS1011
	<b>Ref.: ROD-5014</b>		<b>16'60€</b> <b>Medidas:</b> 4x9x4mm Exterior: Liso Bola: Acero Retenedor: Acero Cerrado-Cerrado
 	Delantero LC01 Delantero LC01L	Delantero LE01 Delantero LE01L	Delantero LP01L Delantero LS1011
	<b>Ref.: ROD-7185</b>		<b>16'80€</b> <b>Medidas:</b> 5x8x3mm Exterior: Liso Bola: Acero Retenedor: Acero Cerrado-Cerrado

## RODAMIENTOS PARA CONTRA ÁNGULOS Y PIEZAS DE MANO RUMAR®

### Rodamientos piezas de mano RUMAR®

RUMAR

Modelos para RUMAR®			Descripción
 	Trasero ECO P1		<b>9'80€</b> <b>Medidas:</b> 5x10x3mm Exterior: Liso Bola: Acero Retenedor: Acero Abierto-Abierto
	<b>Ref.: ROD-313</b>		
 	Delantero ECO P1		<b>10'20€</b> <b>Medidas:</b> 4x8x3mm Exterior: Liso Bola: Acero Retenedor: Acero Cerrado-Cerrado
	<b>Ref.: ROD-314</b>		

# REPUESTOS PARA MICROMOTORES KAVO®



## Rotores compatibles Micromotores KaVo®

RUMAR

	Descripción	Observaciones
	K190 K196 <b>Ref.: BVR-101</b> (Ref. KaVo®: 0.676.0871)	316´80€
	K192 <b>Ref.: BVR-102</b> (Ref. KaVo®: 0.676.0971)	316´80€
	K200 <b>Ref.: BVR-103</b> (Ref. KaVo®: 1.000.6859)	328´00€
	K201 <b>Ref.: BVR-104</b> (Ref. KaVo®: 1.001.8992)	318´00€
	K9 EWL 950 K9 EWL 955 <b>Ref.: BVR-110</b> (Ref. KaVo®: 0.674.1261 / 1.000.2200)	308´00€
	K10 <b>Ref.: BVR-111</b> (Ref. KaVo®: 0.674.3321)	374´80€

## Escobillas compatibles Micromotores KaVo®

RUMAR

	Descripción	Observaciones
	Motores INTRA: K191 K196 K200 K190 K192 K197 K201 <b>Ref.: BVE-260</b> (Ref. KaVo®: 0.676.0881)	1 unidad 11´60€
	K9 <b>Ref.: BVE-250</b> (Ref. KaVo®: 0.676.0241)	1 unidad 11´50€
	K10 <b>Ref.: BVE-251</b> (Ref. KaVo®: 0.674.2481)	1 unidad 12´80€



## Pinzas compatibles Micromotores KaVo®

RUMAR

		Descripción	Observaciones
	2,35 mm	K11 K9 EWL 950 (antiguo) <b>Ref.: BVP-401</b> (Ref. KaVo®: 0.674.7752)	K9 EWL 955 (antiguo) K10 4950 <b>48'50€</b>
	2,35 mm	K10 (excepto 4950) K12 K4 <b>Ref.: BVP-402</b> (Ref. KaVo®: 0.674.4871)	K5 K9 EWL 4930 nuevo (azul) K9 EWL 4932 nuevo (azul) K9 EWL 4933 nuevo (azul) Power Grip todos los modelos <b>52'60€</b>
	2,35 mm	SF EWL 4004 SF EWL 4005 <b>Ref.: BVP-444</b> (Ref. KaVo®: 0.671.1562)	<b>42'80€</b>

## Anillos tóricos compatibles micromotores KaVo®

RUMAR





		Descripción	Observaciones
		Anillo tórico sistema INTRA todos los modelos / <b>TODAS LAS PRIMERAS MARCAS</b> <b>Ref.: OR-148</b> (Ref. KaVo®: 0.200.6120)	<b>1'10€</b>
		Anillo tórico K9, K10 <b>Ref.: OR-2408</b> (Ref. KaVo®: 0.224.2408)	<b>0'90€</b>
		Anillo tórico K4, K5, K9 <b>Ref.: OR-445</b> (Ref. KaVo®: 0.200.6199)	<b>1'00€</b> <span style="background-color: yellow;">HASTA AGOTAR</span>

## Otros repuestos compatibles micromotores KaVo®

RUMAR

		Descripción	Observaciones
		Pasador tope arrastre todos los modelos <b>***Original KaVo®***</b> <b>Ref.: BVX-432</b> (Ref. KaVo®: 0.202.0018)	<b>Medidas:</b> 1x4,5mm <b>Puntero:</b> HE-29523 <b>2'60€</b>
		Tapa K9, K10 (Gris) <b>Ref.: BVX-439</b> (Ref. KaVo®: 0.674.2861)	<b>31'90€</b>
		Tapa SF4005 <b>Ref.: BVX-450</b>	<b>24'80€</b> <span style="background-color: yellow;">HASTA AGOTAR</span>
		Varilla sujeción SF EWL 4004 Varilla sujeción SF EWL 4005 <b>Ref.: BVX-441</b> (Ref. KaVo®: 0.674.3052)	<b>39'80€</b> <span style="background-color: yellow;">HASTA AGOTAR</span>
		Tope de arrastre varilla K9, K10, K11 <b>Ref.: BVX-430</b> (Ref. KaVo®: 0.674.4192)	<b>25'80€</b>
		Pasador tope arrastre todos los modelos <b>***Original KaVo®***</b> <b>Ref.: BVX-432</b> (Ref. KaVo®: 0.202.0018)	<b>Medidas:</b> 1x4,5mm <b>Puntero:</b> HE-29523 <b>2'60€</b>





Descripción		Observaciones
	Lámina SF EWL 4004 Lámina SF EWL 4005 <b>Ref.: BVX-442</b> (Ref. KaVo®: 0.674.3062)	33'80€ <b>HASTA AGOTAR</b>
	Cojinete guía alta frecuencia SF EWL 4004 Cojinete guía alta frecuencia SF EWL 4005 <b>Ref.: BVX-443</b> (Ref. KaVo®: 0.674.0532)	48'80€ <b>HASTA AGOTAR</b>
	Ventilador SF EWL 4004 Ventilador SF EWL 4005 <b>Ref.: BVX-451</b> (Ref. KaVo®: 0.674.2911)	16'80€ <b>HASTA AGOTAR</b>
	Tuerca roscada: K9 EWL 4930 nuevo (azul) K9 EWL 4932 nuevo (azul) <b>Ref.: BVX-255</b> (Ref. 1.000.1260)	K9 EWL 4933 nuevo (azul) K12 9'80€ <b>HASTA AGOTAR</b>

## REPUESTOS PARA MICROMOTORES NSK®



### Escobillas Micromotores NSK®

RUMAR

Descripción		Observaciones
	Volvere y M40 ***Original NSK®*** <b>Ref.: BVE-275</b> (Original Ref. NSK®: E023011S)	Pack 2 uds 69'80€
	MX90 459L 459L <b>Ref.: BVE-270</b>	1 unidad 10'80€

### Pinzas compatibles Micromotores NSK®

RUMAR

Descripción		Observaciones
	2,35 mm Ultimate XL 500 450 Volvere Vmax <b>Ref.: BVP-405</b>	48'00€
	Presto Aqua Lux Presto II Aqua II <b>Ref.: BVP-407</b> (Ref.NSK® T815019)	42'80€

### Anillos tóricos compatibles micromotores NSK®

RUMAR

Descripción		Observaciones
	Anillo tórico sistema INTRA todos los modelos / <b>TODAS LAS PRIMERAS MARCAS</b> <b>Ref.: OR-148</b> (Ref.: NSK®: M154060)	1'10€

## REPUESTOS PARA MICROMOTORES W&H®

### Rotores compatibles Micromotores W&H®

RUMAR

	Descripción	Observaciones
	EB40  <b>Ref.: BVR-117</b> (Ref. W&H®: 04059300)	Incluye: disco teflón, arandelas y rodamientos.  <b>348<sup>00</sup>€</b>

HASTA AGOTAR

### Escobillas compatibles Micromotores W&H®

RUMAR

	Descripción	Observaciones
	ELCO  <b>Ref.: 80-400026</b>	1 unidad  <b>23<sup>80</sup>€</b>

HASTA AGOTAR

### Pinzas micromotores W&H®

RUMAR

	Descripción	Observaciones
	2,35 mm Perfecta (desde N/S 011117) <b>***Original W&amp;H***</b>  <b>Ref.: BVP-5500</b> (original, Ref W&H®: 03205500)	<b>74<sup>80</sup>€</b>

### Anillos tóricos compatibles micromotores W&H®



RUMAR

	Descripción	Observaciones
	Anillo tórico sistema INTRA todos los modelos / <b>TODAS LAS PRIMERAS MARCAS</b>  <b>Ref.: OR-148</b> (Ref.: W&H®: 08162300)	<b>1<sup>10</sup>€</b>

## REPUESTOS PARA MICROMOTORES BIEN AIR®

### Rotores compatibles Micromotores Bien Air®

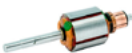
RUMAR

	Descripción	Observaciones
	MC3  <b>Ref.: BVR-117</b> (Ref. Bien Air®: 21175.29 + 011.75.24 + 701.01.70) 150.00.42 / 211.75.29 + 701.01.71 + 1501036 = 1300082 + 1500042 + 1300086 + 1300081 // 701.01.71 +	Incluye: disco teflón, arandelas y rodamientos.  <b>331<sup>80</sup>€</b>
	MC2 40 IR  <b>Ref.: BVR-118</b> (Ref. Bien Air®: 1500932 / 211.36.04)	<b>348<sup>00</sup>€</b>
	MC2 40 LKE  <b>Ref.: BVR-119</b> (Ref. Bien Air®: 150.09.31 / 211.61.16)	<b>348<sup>00</sup>€</b>

## Escobillas Micromotores Bien Air®

RUMAR

	Descripción	Observaciones
	MC2 ***Original Bien Air*** Ref.: <b>BVE-264</b> (Ref. Bien Air®: 211.45.06)	1 unidad 31'80€
	MC3 ***Original Bien Air*** Ref.: <b>BVE-265</b> (original, Ref. Bien Air®: 211.75.08)	1 unidad 31'80€
	MC3 ***Compatible*** Ref.: <b>BVE-268</b> (Ref. Bien Air®: 211.75.08)	1 unidad 16'80€



## Anillos tóricos compatibles micromotores Bien Air®

RUMAR

	Descripción	Observaciones
	Anillo tórico sistema INTRA todos los modelos / <b>TODAS LAS PRIMERAS MARCAS</b> Ref.: <b>OR-148</b> (Ref.: Bien Air®: 1300967 / 705.02.91)	1'10€

## Otros repuestos micromotores Bien Air®

RUMAR

	Descripción	Observaciones
	Pasador tope de arrastre MC2, Aquilón, clavija elástica 1x5 ***Original Bien Air*** Ref.: <b>BVX-165</b> (Ref. Bien Air®: 652.02.02 / 1300664)	Medidas: 1x5 mm Puntero: HE-29523 4'60€
	Pasador tope de arrastre MC3, clavija elástica ***Original Bien Air*** Ref.: <b>BVX-166</b> (Ref. Bien Air®: 652.04.05)	Medidas: 1,5x4,7 mm Puntero: HE-29523 4'80€

## REPUESTOS PARA MICROMOTORES SIRONA®

## Anillos tóricos compatibles micromotores Sirona®



RUMAR

	Descripción	Observaciones
	Anillo tórico sistema INTRA todos los modelos / <b>TODAS LAS PRIMERAS MARCAS</b> Ref.: <b>OR-148</b> (Ref.: Sirona®: 58.60.390)	1'10€

# REPUESTOS PARA MICROMOTORES MK-DENT®

## Rotores Micromotores MK-dent®



	Descripción	Observaciones
	MK-dent EM1190K (N/S<17000) <b>Ref.: BVR-RO1190MK</b>	338 <sup>00</sup> €
 <small>Imagen no disponible</small>	MK-dent EM1190K (N/S>17000) <b>Ref.: BVR-RO1190MK1</b>	364 <sup>80</sup> €







## Escobillas Micromotores MK-dent®



	Descripción	Observaciones
	EM1190K (Pack 2 uds) <b>Ref.: BVE-SP1219/2</b>	Pack 2 unidades 29 <sup>80</sup> €



## Anillos tóricos micromotores MK-dent®









RUMAR

	Descripción	Observaciones
	Anillo tórico sistema INTRA todos los modelos / <b>TODAS LAS PRIMERAS MARCAS</b> <b>Ref.: OR-148</b> (Ref.: MK-dent®: OR3011)	1 <sup>10</sup> €
 <small>Imagen no disponible</small>	Anillo tórico MK-dent® AM1014, AM1016, AM1116 y KaVo® 181 <b>Ref.: OR-1014</b>	1 <sup>40</sup> € <b>HASTA AGOTAR</b>
	Anillo tórico MK-dent® AM1014, AM1016, AM1116 y KaVo® 181 <b>Ref.: OR-1016</b>	1 <sup>40</sup> € <b>HASTA AGOTAR</b>
 <small>Imagen no disponible</small>	Anillo tórico EM1190K <b>Ref.: OR-SP1222</b>	1 Unidad 1 <sup>40</sup> €
 <small>Imagen no disponible</small>	Anillo tórico EM1190K <b>Ref.: OR-SP1228</b>	1 Unidad 1 <sup>30</sup> €
 <small>Imagen no disponible</small>	Anillo tórico EM1190K <b>Ref.: OR-SP1210</b>	1 Unidad 1 <sup>50</sup> € <b>HASTA AGOTAR</b>
 <small>Imagen no disponible</small>	Anillo tórico EM1190K <b>Ref.: OR-SP1214</b>	1 <sup>40</sup> € <b>HASTA AGOTAR</b>

## Otros repuestos micromotores MK-dent®





Imagen no disponible	Descripción	Observaciones
Imagen no disponible	Tapa EM1190K <b>Ref.: BVX-SP1215</b>	4´20€ HASTA AGOTAR
Imagen no disponible	Muelle EM1190K <b>Ref.: BVX-SP1221</b>	1´50€ HASTA AGOTAR
	Anillo de regulación de agua AM1014, AM1016 y AM1116 <b>Ref.: BVX-SP1051</b>	27´80€ HASTA AGOTAR
	Anillo de regulación de aire AM1014, AM1016 y AM1116 <b>Ref.: BVX-SP1052</b>	32´80€ HASTA AGOTAR
Imagen no disponible	Tapa tubo SP1059 del AM1014 <b>Ref.: BVX-SP1056</b>	6´90€ HASTA AGOTAR
Imagen no disponible	Tubito de irrigación AM1014, AM1016 y AM1116 <b>Ref.: BVX-SP1059</b>	7´50€ HASTA AGOTAR
Imagen no disponible	Tapa roscada AM1014, AM1016 y AM1116 <b>Ref.: BVX-SP1060</b>	Llave Ref.: HE-2014 14´30€ HASTA AGOTAR
Imagen no disponible	Disco AM1014, AM1016 y AM1116 <b>Ref.: BVX-SP1061</b>	1´10€ HASTA AGOTAR
Imagen no disponible	Arandela AM1014, AM1016 y AM1116 <b>Ref.: BVX-SP1062</b>	1´80€ HASTA AGOTAR
	Bloque regulación AM1014 <b>Ref.: BVX-SP1063</b>	32´80€ HASTA AGOTAR
Imagen no disponible	Muelle de presión regulador AM1014, AM1016 y AM1116 <b>Ref.: BVX-SP1064</b>	2´30€ HASTA AGOTAR
Imagen no disponible	Regulador AM1014, AM1016 y AM1116 <b>Ref.: BVX-SP1065</b>	3´00€ HASTA AGOTAR
Imagen no disponible	Perno plano AM1014, AM1016 y AM1116 <b>Ref.: BVX-SP1068</b>	3´90€ HASTA AGOTAR

	Descripción	Observaciones
	Cilindro exterior rotor AM1014, AM1016 y AM1116 <b>Ref.: BVX-SP1069</b>	42'90€ <b>HASTA AGOTAR</b>
 <small>Imagen no disponible</small>	Funda protección AM1014, AM1016 y AM1116 <b>Ref.: BVX-SP1074</b>	59'60€ <b>HASTA AGOTAR</b>
 <small>Imagen no disponible</small>	Tornillo AM1014, AM1016 y AM1116 <b>Ref.: BVX-SP1075</b>	5'80€ <b>HASTA AGOTAR</b>
 <small>Imagen no disponible</small>	Tornillo AM1014, AM1016 y AM1116 <b>Ref.: BVX-SP1078</b>	1'80€ <b>HASTA AGOTAR</b>
 <small>Imagen no disponible</small>	Muelle de presión AM1014, AM1016 y AM1116 <b>Ref.: BVX-SP1079</b>	0'95€ <b>HASTA AGOTAR</b>
 <small>Imagen no disponible</small>	Pasador AM1014, AM1016 y AM1116 <b>Ref.: BVX-SP1080</b>	1'40€ <b>HASTA AGOTAR</b>
 <small>Imagen no disponible</small>	Cable goma AM1014 <b>Ref.: BVX-SP1082</b>	0'50€ <b>HASTA AGOTAR</b>
 <small>Imagen no disponible</small>	Cable goma AM1014 <b>Ref.: BVX-SP1083</b>	0'60€ <b>HASTA AGOTAR</b> Medidas: 1x4,5mm Puntero: HE-29523
	Regulador de aire, completo AM1014 <b>Ref.: BVX-SP1089</b>	158'00€ <b>HASTA AGOTAR</b>

## REPUESTOS PARA MICROMOTORES FARO®

### Escobillas Micromotores FARO®



	Descripción	Observaciones
	Única <b>Ref.: 80-406117</b> (Ref. Faro®: 556117)	1 unidad 30'80€
	Modo <b>Ref.: 80-407540</b> (Ref. Faro®: SP557540)	Pack 4 unidades 76'80€

## REPUESTOS PARA MICROMOTORES SAEYANG MARATHON®, SAESHIN®

### Rotores compatibles Micromotores Saeyang Marathon®, Saeshin®

RUMAR

	Descripción	Observaciones
	E Motor SDE-M33ES  <b>Ref.: BVR-120</b>	NO incluye rodamientos Ver: ROD-302 y ROD-354  <b>80<sup>00</sup>€</b>

### Escobillas Compatibles Micromotores Saeyang Marathon®, Saeshin®

RUMAR

	Descripción	Observaciones
	Marathon® Saeshin®  <b>Ref.: BVE-270</b>	1 unidad  <b>10<sup>80</sup>€</b>

## REPUESTOS PARA MICROMOTORES MARATHON®

### Pinzas compatibles micromotores Marathon®

RUMAR

	Descripción	Observaciones
	2,35 mm Marathon®  <b>Ref.: BVP-406</b>	<b>29<sup>80</sup>€</b>
 <small>Imagen no disponible</small>	2,35 mm Pinza para micromotor Saeshin®  <b>Ref.: BVP-410</b>	Forte 100 II Forte 103L Forte 107  <b>48<sup>00</sup>€</b>
 <small>Imagen no disponible</small>	2,35 mm Pinza para micromotor Saeshin®  <b>Ref.: BVP-411</b>	Forte 100a III Forte 106 -ZO Forte 100  <b>48<sup>00</sup>€</b>
 <small>Imagen no disponible</small>	2,35 mm Pinza para micromotor Saeshin®  <b>Ref.: BVP-412</b>	Forte 300 II Forte 300 III Forte 102 Forte 105L  <b>48<sup>00</sup>€</b>

Todos los rodamientos que ofrecemos están fabricados por los principales fabricantes de rodamientos a nivel mundial: **myonic**, **HQW-Barden**, **GRW**, **NMB**, **EZO** o **ESC**. Todos fabricados de acuerdo a las normas de precisión ISO\* (normas para rodamientos de dimensiones métricas) y ABEC\*\* (rodamientos generalmente en dimensiones de pulgadas).

\* ISO: International Standard Organization.



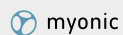

\*\* ABEC: Annular Bearing Engineers Conference.



## RODAMIENTOS PARA MICROMOTORES KAVO®

### Rodamientos micromotores eléctricos KaVo® K190, K191, K192, K196 y K197



RUMAR

Modelos para KaVo®		Descripción
 	Delantero  <b>Ref.: ROD-0089</b> (Ref. KaVo®: 0.220.0089)	<b>Medidas:</b> 4x11x4mm Exterior: Liso Bola: Acero Retenedor: TN9 Sintético Abierto - Cerrado  <b>9'20€</b>
 	Trasero  <b>Ref.: ROD-0136</b> (Ref. KaVo®: 0.220.0136)	<b>Medidas:</b> 2x6x2,3mm Exterior: Liso Bola: Acero Retenedor: THB Phenolic Abierto - Cerrado  <b>12'80€</b>

Kit 2 rodamientos: ROD-0089 + ROD-0136

### Rodamientos micromotores eléctricos KaVo® KL700



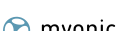

RUMAR

Modelos para KaVo®		Descripción
 	Delantero  <b>Ref.: ROD-200</b> (Ref. KaVo®: 0.220.0219)	<b>Medidas:</b> 5x11x5mm Exterior: Liso Bola: Acero Retenedor: Acero Cerrado - Cerrado  <b>12'80€</b>
 	Trasero  <b>Ref.: ROD-0218</b> (Ref. KaVo®: 0.220.0218)	<b>Medidas:</b> 3x8x3mm Exterior: Liso Bola: Acero Retenedor: Acero Cerrado - Cerrado  <b>11'80€</b>

Kit 2 rodamientos: ROD-200 + ROD-0218

### Rodamientos micromotores eléctricos KaVo® KL701

RUMAR





Modelos para KaVo®		Descripción
 	Delantero  <b>Ref.: ROD-7185</b> (Ref. KaVo®: 1.000.7185)	<b>Medidas:</b> 5x8x3mm Exterior: Liso Bola: Acero Retenedor: Acero Cerrado - Cerrado  <b>16'80€</b>
 	Trasero  <b>Ref.: ROD-0218</b> (Ref. KaVo®: 0.220.0218)	<b>Medidas:</b> 3x8x3mm Exterior: Liso Bola: Acero Retenedor: Acero Cerrado - Cerrado  <b>11'80€</b>

Kit 2 rodamientos: ROD-7185 + ROD-0218

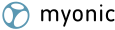

## Rodamientos micromotores eléctricos KaVo® K200













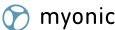

RUMAR

Modelos para KaVo®		Descripción
 	Delantero  <b>Ref.: ROD-7185</b> (Ref. KaVo®: 1.000.7185)	<b>Medidas:</b> 5x8x3mm Exterior: Liso Bola: Acero Retenedor: Acero Cerrado - Cerrado  <b>16'80€</b>
  	Trasero  <b>Ref.: ROD-0136</b> (Ref. KaVo®: 0.220.0136)	<b>Medidas:</b> 2x6x2,3mm Exterior: Liso Bola: Acero Retenedor: THB Phenolic Abierto - Cerrado  <b>12'80€</b>

Kit 2 rodamientos: ROD-7185 + ROD-0136







## Rodamientos micromotores eléctricos KaVo® K9 antiguo (K9 EWL 950 / 955)

RUMAR

Modelos para KaVo®		Descripción
  	Delantero inducido  <b>Ref.: ROD-2157</b> (Ref. KaVo®: 0.220.0157)	<b>Medidas:</b> 4x11x4mm Exterior: Liso Bola: Acero Retenedor: Acero Cerrado - Cerrado  <b>14'80€</b>
 	Trasero inducido  <b>Ref.: ROD-2158</b> (Ref. KaVo®: 0.220.0158)	<b>Medidas:</b> 2x6x2,3mm Exterior: Liso Bola: Acero Retenedor: Acero Cerrado - Cerrado  <b>15'80€</b>
  	Eje K9 EWL 950 Trasero Eje K9 EWL 955  <b>Ref.: ROD-2113</b> (Ref. KaVo®: 0.220.0113)	<b>Medidas:</b> 8x16x6mm Exterior: Liso Bola: Acero Retenedor: TN9 Sintético Cerrado - Cerrado  <b>11'80€</b>
  	Delantero eje K9 EWL 955  <b>Ref.: ROD-2148</b> (Ref. KaVo®: 0.220.0148)	<b>Medidas:</b> 8x14x4mm <b>Velocidad:</b> 20.000 rpm Exterior: Liso Bola: Acero Retenedor: TN9 Sintético Cerrado - Cerrado  <b>13'80€</b>
   	Kit 2 rodamientos inducido: 30-2157 + 30-2158  <b>Ref.: ROD-2011</b>	<b>24'60€</b>



## Rodamientos micromotores eléctricos KaVo® K9 (azul) (K9 EWL 4930 / 4932 / 4933)





RUMAR

Modelos para KaVo®		Descripción
 HAW BARDEN	Delantero inducido  Ref.: <b>ROD-2223</b> (Ref. KaVo®: 0.220.0223)	<b>Medidas:</b> 5x11x4mm Exterior: Liso Bola: Acero Retenedor: Acero Cerrado - Cerrado  <b>13'80€</b>
 myonic	Trasero inducido  Ref.: <b>ROD-2158</b> (Ref. KaVo®: 0.220.0158)	<b>Medidas:</b> 2x6x2,3mm Exterior: Liso Bola: Acero Retenedor: Acero Cerrado - Cerrado  <b>15'80€</b>
 HAW BARDEN	Delantero eje  Ref.: <b>ROD-2055</b> (Ref. KaVo®: 0.220.0055)	<b>Medidas:</b> 7x14x1x7,5mm Exterior: Liso Bola: Acero Retenedor: TN9 Sintético Cerrado - Cerrado  <b>45'80€</b>
 myonic	Trasero eje  Ref.: <b>ROD-2044</b> (Ref. KaVo®: 0.220.0044)	<b>Medidas:</b> 7,85x15,89x5,98mm Exterior: Liso Bola: Acero Retenedor: TN9 Sintético Cerrado - Cerrado  <b>26'80€</b>
 myonic + HAW BARDEN	Kit 2 rodamientos inducido: 30-2223 + 30-2158  Ref.: <b>ROD-2111</b>	<b>24'80€</b>
 myonic + HAW BARDEN	Kit 2 rodamientos eje: 30-2055 + 30-2044  Ref.: <b>ROD-2112</b>	<b>65'80€</b>

## Rodamientos micromotores eléctricos KaVo® K10











RUMAR

Modelos para KaVo®		Descripción
 HAW BARDEN	Delantero inducido  Ref.: <b>ROD-2779</b> (Ref. KaVo®: 0.220.0779)	<b>Medidas:</b> 4x11x4mm Exterior: Liso Bola: Acero Retenedor: TN9 Sintético Cerrado - Cerrado  <b>15'80€</b>
 HAW BARDEN	Trasero inducido  Ref.: <b>ROD-2778</b> (Ref. KaVo®: 0.220.0778)	<b>Medidas:</b> 3x8x4mm Exterior: Liso Bola: Acero Retenedor: TN9 Sintético Cerrado - Cerrado  <b>18'80€</b>
 HAW BARDEN	Eje K10  Ref.: <b>ROD-2113</b> (Ref. KaVo®: 0.220.0113)	<b>Medidas:</b> 8x16x6mm Exterior: Liso Bola: Acero Retenedor: TN9 Sintético Cerrado - Cerrado  <b>11'80€</b>

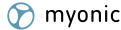
Modelos para KaVo®		Descripción
 	Kit 2 rodamientos inducido: 30-2778 + 30-2779  <b>Ref.: ROD-2021</b>	<b>32'50€</b>
 	Kit 2 rodamientos eje: 2X 30-2113  <b>Ref.: ROD-2000</b>	<b>19'30€</b>

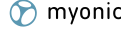
## Rodamientos micromotores eléctricos KaVo® K11







# RUMAR

Modelos para KaVo®		Descripción
 	Trasero inducido  <b>Ref.: ROD-2778</b> (Ref. KaVo®: 0.220.0778)	<b>Medidas:</b> 3x8x4mm Exterior: Liso Bola: Acero Retenedor: TN9 Sintético Cerrado - Cerrado  <b>18'80€</b>
 	Delantero inducido  <b>Ref.: ROD-2779</b> (Ref. KaVo®: 0.220.0779)	<b>Medidas:</b> 4x11x4mm Exterior: Liso Bola: Acero Retenedor: TN9 Sintético Cerrado - Cerrado  <b>15'80€</b>
 	Delantero eje  <b>Ref.: ROD-2045</b> (Ref. KaVo®: 0.220.0045)	<b>Medidas:</b> 7,85x15,89x7,5mm Exterior: Liso Bola: Acero Retenedor: TN9 Sintético Abierto - Cerrado  <b>69'80€</b>
 	Trasero eje  <b>Ref.: ROD-2044</b> (Ref. KaVo®: 0.220.0044)	<b>Medidas:</b> 7,85x15,89x5,98mm Exterior: Liso Bola: Acero Retenedor: TN9 Sintético Cerrado - Cerrado  <b>26'80€</b>
 	Kit 2 rodamientos inducido: 30-2778 + 30-2779  <b>Ref.: ROD-2021</b>	<b>32'50€</b>
 	Kit 2 rodamientos eje: 30-2045 + 30-2044  <b>Ref.: ROD-2031</b>	<b>92'30€</b>

**Kit Ref. KaVo 0.674.2841:**  
 0.200.0827 + 0.220.0045 + 2X0.222.4042 + 0.220.0044 = 0.200.0827 + ROD-2045 + 2X0.222.4042 + ROD-2044



## Rodamientos micromotores eléctricos KaVo® K12 / Power Grip todos los modelos

RUMAR

Modelos para KaVo®		Descripción
 HAW BARDEN	Delantero inducido <b>Ref.: ROD-2779</b> (Ref. KaVo: 0.220.0779)	<b>Medidas:</b> 4x11x4mm Exterior: Liso Bola: Acero Retenedor: TN9 Sintético Cerrado - Cerrado <b>15'80€</b>
 HAW BARDEN	Trasero inducido <b>Ref.: ROD-2778</b> (Ref. KaVo®: 0.220.0778)	<b>Medidas:</b> 3x8x4mm Exterior: Liso Bola: Acero Retenedor: TN9 Sintético Cerrado - Cerrado <b>18'80€</b>
 HAW BARDEN	Delantero eje <b>Ref.: ROD-2055</b> (Ref. KaVo®: 0.220.0055)	<b>Medidas:</b> 7x14x1x7,5mm Exterior: Liso Bola: Acero Retenedor: TN9 Sintético Cerrado - Cerrado <b>45'80€</b>
 myonic	Trasero eje <b>Ref.: ROD-2044</b> (Ref. KaVo®: 0.220.0044)	<b>Medidas:</b> 7,85x15,89x5,98mm Exterior: Liso Bola: Acero Retenedor: TN9 Sintético Cerrado - Cerrado <b>26'80€</b>
 HAW BARDEN	Kit 2 rodamientos inducido: 30-2778 + 30-2779 <b>Ref.: ROD-2021</b>	<b>32'50€</b>
 myonic + HAW BARDEN	Kit 2 rodamientos eje: 30-2055 + 30-2044 <b>Ref.: ROD-2112</b>	<b>65'80€</b>



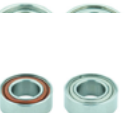

## Rodamientos micromotores eléctricos KaVo® K4 / K5

RUMAR

Modelos para KaVo®		Descripción
 HAW BARDEN	Delantero <b>Ref.: ROD-2058</b> (Ref. KaVo®: 0.220.0058 + 2x0.200.6199 + 0.200.0692)	<b>Medidas:</b> 7x14x1x7,5mm <b>Incluye:</b> Tóricos y fieltro <b>Especial</b> Exterior: Liso Bola: Acero Retenedor: TN9 Sintético Cerrado - Cerrado <b>62'80€</b>
 HAW BARDEN	Trasero <b>Ref.: ROD-2056</b> (Ref. KaVo®: 0.220.0056)	<b>Medidas:</b> 10x19x7mm Exterior: Liso Bola: Acero Retenedor: TN9 Sintético Cerrado - Cerrado <b>21'80€</b>
 HAW BARDEN	Kit 2 rodamientos inducido: 30-2056 + 30-2058 <b>Ref.: ROD-2050</b>	<b>80'80€</b>

## Rodamientos micromotores eléctricos KaVo® SF EWL 4004 / 4005

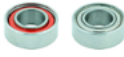
RUMAR

Modelos para KaVo®		Descripción
  	Rodamiento delantero  <b>Ref.: ROD-6057</b> (Ref. KaVo®: 0.247.6057)	<b>Medidas:</b> 8x22x7mm Exterior: Liso Bola: Acero Retenedor: THB Phenolic Abierto - Cerrado  <b>18´90€</b>
  	Rodamiento trasero  <b>Ref.: ROD-0112</b> (Ref. KaVo®: 0.220.0112)	<b>Medidas:</b> 7x14x5mm Exterior: Liso Bola: Acero Retenedor: TN9 Sintético Abierto - Cerrado  <b>25´80€</b>

## Rodamientos micromotores neumáticos KaVo®











RUMAR

Modelos para KaVo®		Descripción
 	181M  <b>Ref.: ROD-310</b> (Ref. KaVo®: 0.220.0021)	<b>Medidas:</b> 3x7x2mm Exterior: Liso Bola: Acero Retenedor: Bronce Abierto-Abierto  <b>24´80€</b>

## RODAMIENTOS PARA MICROMOTORES NSK®

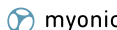

## Rodamientos micromotores eléctricos NSK® ULTIMATE, VOLVERE Y UHR

RUMAR

Modelos para NSK®		Descripción
  	Trasero eje  <b>Ref.: ROD-220</b> (Ref. NSK®: B11243-1306)	<b>Medidas:</b> 6X13x5mm Exterior: Liso Bola: Acero Retenedor: TN9 Sintético Cerrado - Cerrado  <b>9´80€</b>
  	Delantero eje  <b>Ref.: ROD-221</b> (Ref. NSK®: B20245-2763)	<b>Medidas:</b> 6,35X12,7X4,763mm Exterior: Liso Bola: Acero Retenedor: TN9 Sintético Cerrado - Cerrado  <b>17´60€</b>
 	Volvere rotor  <b>Ref.: ROD-683</b>	<b>Medidas:</b> 3x7x3mm Exterior: Liso Bola: Acero Retenedor: Acero Cerrado - Cerrado  <b>14´80€</b>
  	Ultimate rotor  <b>Ref.: ROD-327</b>	<b>Medidas:</b> 4x9x4mm Exterior: Liso Bola: Acero Retenedor: TN9 Sintético Cerrado - Cerrado  <b>14´80€</b>

## Rodamientos micromotores neumáticos NSK®







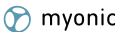

RUMAR

Modelos para NSK®		Descripción
	EX103 EX203 MX200 EX100	IS205 TI205 PTL950TI TI205L
	EX203C	<b>Medidas:</b> 2,38x7,938x3,571mm Exterior: Liso Bola: Acero Retenedor: Acero Cerrado-Cerrado
	<b>Ref.: ROD-311</b> (Ref. NSK®: B22227-7923)	<b>14'60€</b>

## RODAMIENTOS PARA MICROMOTORES W&amp;H®



## Rodamientos micromotores eléctricos W&amp;H®

RUMAR

Modelos para W&H®		Descripción
	Delantero inducido MF Techtorque Delantero inducido MF Perfecta	<b>Medidas:</b> 5x11x5mm <b>Especial</b> Exterior: Liso Bola: Acero Retenedor: Acero Cerrado - Cerrado
	<b>Ref.: ROD-200</b> (Ref. W&H®: 02685500)	<b>12'80€</b>
	Trasero inducido MF Techtorque Trasero inducido MF Perfecta	<b>Medidas:</b> 3x8x4mm Exterior: Liso Bola: Acero Retenedor: TN9 Sintético Cerrado - Cerrado
	<b>Ref.: ROD-2778</b> (Ref. W&H®: 01206200)	<b>18'80€</b>
	Delantero pieza de mano azul / negra MF Techtorque Delantero pieza de mano azul / negra MF Perfecta	<b>Medidas:</b> 8x16x6mm Exterior: Liso Bola: Acero Retenedor: TN9 Sintético Cerrado - Cerrado
	<b>Ref.: ROD-2113</b> (Ref. W&H®: 03202300)	<b>11'80€</b>
	Trasero pieza de mano azul / negra MF Techtorque Trasero pieza de mano azul / negra MF Perfecta	<b>Medidas:</b> 7x14x5mm Exterior: Liso Bola: Acero Retenedor: TN9 Sintético Cerrado - Cerrado
	<b>Ref.: ROD-203</b> (Ref. W&H®: 03202200)	<b>19'50€</b>
	Perfecta 300	<b>Medidas:</b> 4x9x4mm Exterior: Liso Bola: Acero Retenedor: TN9 Sintético Cerrado - Cerrado
	<b>Ref.: ROD-327</b>	<b>14'80€</b>

## Rodamientos micromotores neumáticos W&amp;H®

RUMAR

Modelos para W&H®		Descripción
	A25 E25 LT25	<b>Medidas:</b> 3,175x7,938x3,571mm Exterior: Liso Bola: Acero Retenedor: Acero Cerrado-Cerrado
	<b>Ref.: ROD-133</b> (Ref. W&H®: 01850600)	<b>12'20€</b>

## RODAMIENTOS PARA MICROMOTORES BIEN AIR®

### Rodamientos micromotores eléctricos Bien Air® MC3

RUMAR

Modelos para Bien Air®		Descripción
  	Delantero  <b>Ref.: ROD-130</b> (Ref. Bien Air®: 701.01.71 / 1300082)	<b>Medidas:</b> 4x11x4mm Exterior: Liso Bola: Acero Retenedor: Acero Cerrado - Cerrado  <b>15´20€</b>
  	Trasero  <b>Ref.: ROD-131</b> (Ref. Bien Air®: 701.01.70 / 1300081)	<b>Medidas:</b> 2,38x7,938x3,571mm Exterior: Liso Bola: Acero Retenedor: Acero Cerrado - Cerrado  <b>16´40€</b>

### Rodamientos micromotores eléctricos Bien Air® MC2

RUMAR

Modelos para Bien Air®		Descripción
  	Trasero (Excepto Aquilón)  <b>Ref.: ROD-132</b> (Ref. Bien Air®: 701.01.23 / 1301107)	<b>Medidas:</b> 2,38x7,938x9,05x3,571mm Exterior: Con reborde Bola: Acero Retenedor: Acero Cerrado - Cerrado  <b>15´50€</b>
  	Delantero Aquilón (delantero y trasero)  <b>Ref.: ROD-133</b> (Ref. Bien Air®: 701.01.14 / 1300985)	<b>Medidas:</b> 3,175x7,938x3,571mm Exterior: Liso Bola: Acero Retenedor: Acero Cerrado - Cerrado  <b>16´80€</b>

### Rodamientos micromotores eléctricos Bien Air® MX





RUMAR

Modelos para Bien Air® MX		Descripción
 	Delantero  <b>Ref.: ROD-134</b> (Ref. Bien Air®: 701.01.93)	<b>Medidas:</b> 4,763x7,938x3,175mm Exterior: Liso Bola: Acero Retenedor: Acero Cerrado - Cerrado  <b>14´80€</b>
 	Trasero  <b>Ref.: ROD-135</b> (Ref. Bien Air®: 701.01.94)	<b>Medidas:</b> 3,967x7,938x3,175mm Exterior: Liso Bola: Acero Retenedor: Acero Cerrado - Cerrado  <b>14´80€</b>

## RODAMIENTOS PARA MICROMOTORES SIRONA®

Rodamientos micromotores eléctricos Sirona®



RUMAR

Modelos para Sirona®		Descripción
 	SLI, delantero  <b>Ref.: ROD-350</b> (Ref. Sirona®: 7040801)	<b>Medidas:</b> 4x9x4mm Exterior: Con reborde Bola: Acero Retenedor: Acero Cerrado - Cerrado  <b>12'90€</b>
 	SLI, trasero  <b>Ref.: ROD-351</b> (Ref. Sirona®: 7036130)	<b>Medidas:</b> 2x6x2,3mm Exterior: Con reborde Bola: Acero Retenedor: Acero Cerrado - Cerrado  <b>19'50€</b>

## RODAMIENTOS PARA MICROMOTORES MK-DENT®

Rodamientos micromotores neumáticos MK-dent®

RUMAR













Modelos para MK-dent®		Descripción
 	AM1014  <b>Ref.: ROD-310</b>	<b>Medidas:</b> 3x7x2mm Exterior: Liso Bola: Acero Retenedor: Bronce Abierto-Abierto  <b>24'80€</b>



# RODAMIENTOS PARA MICROMOTORES SAEYANG MARATHON®

Rodamientos micromotores eléctricos **SAEYANG MARATHON®**















RUMAR

Modelos para Saeyang Marathon®			Descripción
 	H20 H35SP1 H37L1 SH37L1	H37LN H37(L)SP H35LS M45	SH20N (30K) H300 (Ø3)  <b>Medidas:</b> 6x12x4mm Exterior: Liso Bola: Acero Retenedor: TN9 Sintético Cerrado - Cerrado
 	Eje trasero H20 Eje trasero H200 (12V) Eje trasero H200 (30V) Eje trasero H35SP1 Eje trasero H37L1	Eje trasero SH37L1 Eje trasero H37LN Eje trasero H37(L) SP Eje trasero H35LS Eje trasero M45	Eje trasero SH20N(30K) Eje trasero SH37LN Eje trasero MH20 (12V) Eje trasero MH24 (24V) Eje trasero H300 (Ø3)  <b>Medidas:</b> 8x14x4mm <b>Velocidad:</b> 45.000 rpm Exterior: Liso Bola: Acero Retenedor: TN9 Sintético Cerrado - Cerrado
 	SH37LN SH40C BM50S1	BM50K BSS0C BM40S1	BM40C BHS1 BHK  <b>Medidas:</b> 6x13x5mm Exterior: Liso Bola: Acero Retenedor: TN9 Sintético Cerrado - Cerrado
 	Delantero M20ES Delantero M25ES Delantero M33E Delantero M33ES Delantero M40ES Delantero H20 Delantero H200 (12V)	Delantero H200 (30V) Delantero H35SP1 Delantero H37L1 Delantero SH37L1 Delantero H37LN Delantero H37(L) SP Delantero H35LS	Delantero M45 Delantero SH20N (30K) Delantero SH37LN Delantero SH40C  <b>Medidas:</b> 3x10x4mm Exterior: Liso Bola: Acero Retenedor: Acero Abierto - Abierto
 <small>Imagen no disponible</small> 	Trasero M20ES Trasero M25ES Trasero M33ES Trasero M40ES	Trasero H20 Trasero H200 (12V) Trasero H200 (30V) Trasero H37LN	Trasero H37(L) SP Trasero H35LS  <b>Medidas:</b> 3x8x4mm Exterior: Liso Bola: Acero Retenedor: TN9 Sintético Cerrado - Cerrado
 	Delantero eje BH50		<b>Medidas:</b> 6,35X12,7X4,763mm Exterior: Liso Bola: Acero Retenedor: TN9 Sintético Cerrado - Cerrado

# RODAMIENTOS PARA MICROMOTORES SAESHIN®

Rodamientos micromotores eléctricos SAESHIN®

RUMAR

Modelos para SAESHIN®		Descripción
 Imagen no disponible  	Inducido  <b>Ref.: ROD-354</b> (Ref. Saeshin®: 830ZZ)	<b>Medidas:</b> 3x8x4mm Exterior: Liso Bola: Acero Retenedor: TN9 Sintético Cerrado - Cerrado  <b>9'80€</b>
 Imagen no disponible  	Inducido  <b>Ref.: ROD-355</b> (Ref. Saeshin®: 940ZZ)	<b>Medidas:</b> 4x9x4mm Exterior: Liso Bola: Acero Retenedor: TN9 Sintético Cerrado - Cerrado  <b>9'80€</b>
 Imagen no disponible  	Eje  <b>Ref.: ROD-356</b> (Ref. Saeshin®: 1050ZZ)	<b>Medidas:</b> 5x10x4mm Exterior: Liso Bola: Acero Retenedor: TN9 Sintético Cerrado - Cerrado  <b>9'80€</b>
 Imagen no disponible  	Eje  <b>Ref.: ROD-357</b> (Ref. Saeshin®: 1370ZZ)	<b>Medidas:</b> 7x13x4mm Exterior: Liso Bola: Acero Retenedor: TN9 Sintético Cerrado - Cerrado  <b>9'80€</b>
 	Eje  <b>Ref.: ROD-234</b> (Ref. Saeshin®: 1480ZZ)	<b>Medidas:</b> 8x14x4mm Exterior: Liso Bola: Acero Retenedor: TN9 Sintético Cerrado - Cerrado  <b>9'80€</b>



NUEVO

RFE

## ▶ REPUESTOS PARA SILLONES FEDESA®

- Filtros para sillones Fedesa®
- Botoneras para sillones Fedesa®
- Válvulas, electroválvulas y otros para sillones Fedesa®
- Muelles para sillones Fedesa®
- Motores elevadores para sillones Fedesa®
- Varios repuestos para sillones Fedesa®
- Pistones para sillones Fedesa®

... hasta aquí los repuestos específicos para sillones Fedesa®,  
para **+ REPUESTOS SILLONES FEDESA®** :

+ REPUESTOS SILLONES FEDESA®

Ver Sección

- ▶ Mangueras sillones Fedesa® ..... Mangueras equipo
- ▶ Repuestos lámparas sillones Fedesa® ..... Repuestos lámparas Faro®
- ▶ Jeringas y repuestos jeringas sillones Fedesa® ..... Jeringas y repuestos jeringas
- ▶ Válvulas sillones Fedesa® ..... Válvulas y electroválvulas
- ▶ Filtros, mangueras, terminales y otros sistemas de aspiración sillones Fedesa® ..... Sistemas de aspiración y sus repuestos
- ▶ Reguladores de presión sillones Fedesa® ..... Reguladores de presión
- ▶ Racores, conectores y espigas sillones Fedesa® ..... Racores, conectores y espigas
- ▶ Pedales sillones Fedesa® ..... Pedales y sus repuestos

PRÓXIMAMENTE NUEVAS REFERENCIAS ¡CONSÚLTANOS!



## FILTROS PARA SILLONES FEDESA®

Filtros para sillones Fedesa®

RUMAR

### Descripción

### Observaciones

	<p>Filtro amarillo Dürr® Aspiraciones ***Original Dürr®***</p> <p>Ref.: <b>68-37001</b> (Ref. Dürr®: 0725.041.00)</p>	<p>Pack 12 uds. Utilizado en el <b>20%</b> de los sillones Fedesa®</p> <p><b>38'80€</b></p>
<p>NUEVO</p> 	<p>Filtro sólidos aspiraciones Cattani® ***Original Cattani®***</p> <p>Ref.: <b>38-1055</b> (Ref. Cattani®: 1041055   Ref. Fedesa®: F034A91)</p>	<p>Pack 1 ud. Utilizado en el <b>80%</b> de los sillones Fedesa®</p> <p><b>15'20€</b></p>

Mangueras, terminales de aspiración y relacionados sillones Fedesa®  
Ver sección: Sistemas de aspiración y sus repuestos









## BOTONERAS PARA SILLONES FEDESA®

Botoneras para sillones Fedesa®

RUMAR

### Descripción

### Observaciones

<p>NUEVO</p>		<p>Botonera digital bandeja JS250 para sillones Fedesa®</p> <p>Ref.: <b>FED-082A63</b> (Ref. Fedesa®: 082A63)</p>	 <p><b>51'80€*</b></p> <p>▶ *Sin descuento</p>
<p>NUEVO</p>		<p>Botonera soporte cánulas JS250 para sillones Fedesa®</p> <p>Ref.: <b>FED-082A64</b> (Ref. Fedesa®: 082A64)</p>	 <p><b>24'80€*</b></p> <p>▶ *Sin descuento</p>
<p>NUEVO</p>		<p>Botonera bandeja Astral para sillones Fedesa®</p> <p>Ref.: <b>FED-082A90</b> (Ref. Fedesa®: 082A90)</p>	 <p><b>40'00€*</b></p> <p>▶ *Sin descuento</p>
<p>NUEVO</p>		<p>Botonera digital soporte cánulas Astral para sillones Fedesa®</p> <p>Ref.: <b>FED-082A91</b> (Ref. Fedesa®: 082A91)</p>	 <p><b>25'80€*</b></p> <p>▶ *Sin descuento</p>

OTRAS BOTONERAS FEDESA ¡CONSÚLTANOS!

TODAS LAS BOTONERAS QUE NO APARECEN COMO **En Stock** SE ENCUENTRAN **BAJO PEDIDO**

**¡CONSÚLTANOS!**



SI NO ENCUENTRAS EL REPUESTO QUE BUSCAS, ¡CONSÚLTANOS!  
Precios: impuestos, portes y mano de obra no incluidos.













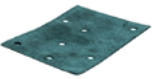



# VÁLVULAS, ELECTROVÁLVULAS Y OTROS PARA SILLONES FEDESA®

Válvulas, electroválvulas y otros para sillones Fedesa®

RUMAR

## Descripción





## Observaciones

NUEVO		<p>Grupo distribuidor 3 instrumentos equipos Fedesa®</p> <p>Ref.: <b>FED-317A04</b> (Ref. Fedesa®: 317A04)</p>	 <p>98'00€*</p>	<p>Repuesto relacionado: VE-7031</p> <p>*Sin descuento</p>
		<p>Membrana bloque 3 instrumentos, <b>tipo DCI (Ref.: VE-703)</b></p> <p>Ref.: <b>VE-7031</b> (Ref. Fedesa®: 317A02)</p>	<p>14'80€</p>	<p>Repuesto compatible con bloques FED-317A04 (Ref. Fedesa® 317A02) y relacionado con VE-703</p>
NUEVO		<p>Bloque 2 electroválvulas</p> <p>Ref.: <b>FED-054A05</b> (Ref. Fedesa®: 054A05)</p>	 <p>80'00€*</p>	<p><b>Voltaje:</b> 24 V AC 50 Hz Repuestos relacionados: FED-237A12 y FED-237A03</p> <p>*Sin descuento</p>
NUEVO		<p>Bobina 5VA</p> <p>Ref.: <b>FED-237A14</b> (Ref. Fedesa®: 237A14)</p>	 <p>12'80€*</p>	<p><b>Diámetro:</b> 9 mm <b>Voltaje:</b> 24 V AC Repuesto para bloque Fedesa Ref.: 054A04</p> <p>*Sin descuento</p>
NUEVO		<p>Bobina 7VA con núcleo</p> <p>Ref.: <b>FED-237A03</b> (Ref. Fedesa®: 237A03)</p>	 <p>32'80€*</p>	<p><b>Voltaje:</b> 24 V AC Repuesto para bloque Fedesa Ref.: 054A05</p> <p>*Sin descuento</p>
NUEVO		<p>Núcleo + guía latón EV agua</p> <p>Ref.: <b>FED-237A12</b> (Ref. Fedesa®: 237A12)</p>	 <p>18'80€*</p>	<p>Repuesto para bloque Fedesa Ref.: 054A05</p> <p>*Sin descuento</p>
NUEVO		<p>Conjunto 24 V AC</p> <p>Ref.: <b>FED-054A04</b> (Ref. Fedesa®: 054A04)</p>	 <p>23'80€*</p>	<p>Repuesto relacionado: FED-237A14</p> <p>*Sin descuento</p>
NUEVO		<p>Placa conexión 28 con junta</p> <p>Ref.: <b>FED-185A65</b> (Ref. Fedesa®: 185A65)</p>	 <p>28'80€*</p>	<p>*Sin descuento</p>
NUEVO		<p>Filtro bronce</p> <p>Ref.: <b>FED-275A09</b> (Ref. Fedesa®: 275A09)</p>	 <p>2'80€*</p>	<p>*Sin descuento</p>

## PRÓXIMAMENTE NUEVAS REFERENCIAS ¡CONSÚLTANOS!

## Descripción

## Observaciones

NUEVO		Muelle Fedesa®  Ref.: <b>FED-575A70</b>	 0'80€*	*Sin descuento
NUEVO		Muelle Fedesa®  Ref.: <b>FED-575A55</b>	 0'90€*	*Sin descuento







## MUELLES PARA SILLONES FEDESA®

Muelles para sillones Fedesa®











RUMAR

## Descripción

## Observaciones





NUEVO		Muelle Fedesa®  Ref.: <b>FED-440A01</b> (Ref. Fedesa®: 440A01)	6'00€	
NUEVO		Muelle Fedesa®  Ref.: <b>FED-440A03</b> (Ref. Fedesa®: 440A03)	7'00€	
NUEVO		Muelle Fedesa®  Ref.: <b>FED-440A05</b> (Ref. Fedesa®: 440A05)	11'80€	
NUEVO		Muelle Fedesa®  Ref.: <b>FED-440A06</b> (Ref. Fedesa®: 440A06)	6'00€	
NUEVO		Muelle Fedesa®  Ref.: <b>FED-440A09</b> (Ref. Fedesa®: 440A09)	16'80€	
NUEVO		Muelle Fedesa®  Ref.: <b>FED-440A13</b> (Ref. Fedesa®: 440A13)	15'80€	

## PRÓXIMAMENTE NUEVAS REFERENCIAS ¡CONSÚLTANOS!

	Descripción	Observaciones
NUEVO	 <p>Muelle Fedesa®</p> <p>Ref.: <b>FED-440A13-1</b> (Ref. Fedesa®: 440A13-1)</p>	15'80€
NUEVO	 <p>Muelle Fedesa®</p> <p>Ref.: <b>FED-440A18</b> (Ref. Fedesa®: 440A18)</p>	6'30€
NUEVO	 <p>Muelle Fedesa®</p> <p>Ref.: <b>FED-440A20</b> (Ref. Fedesa®: 440A20)</p>	6'80€
NUEVO	 <p>Muelle Fedesa®</p> <p>Ref.: <b>FED-440A21</b> (Ref. Fedesa®: 440A21)</p>	5'80€
NUEVO	 <p>Muelle Fedesa®</p> <p>Ref.: <b>FED-440A23</b> (Ref. Fedesa®: 440A23)</p>	15'80€
NUEVO	 <p>Muelle Fedesa®</p> <p>Ref.: <b>FED-440A28</b> (Ref. Fedesa®: 440A28)</p>	13'80€
NUEVO	 <p>Muelle Fedesa®</p> <p>Ref.: <b>FED-440A29</b> (Ref. Fedesa®: 440A29)</p>	15'80€
NUEVO	 <p>Muelle Fedesa®</p> <p>Ref.: <b>FED-440A29-1</b> (Ref. Fedesa®: 440A29-1)</p>	15'80€
NUEVO	 <p>Muelle Fedesa®</p> <p>Ref.: <b>FED-440A33</b> (Ref. Fedesa®: 440A33)</p>	16'80€
NUEVO	 <p>Muelle Fedesa®</p> <p>Ref.: <b>FED-440A34</b> (Ref. Fedesa®: 440A34)</p>	16'80€





## PRÓXIMAMENTE NUEVAS REFERENCIAS ¡CONSÚLTANOS!

	Descripción	Observaciones
NUEVO	 <p>Muelle Fedesa®</p> <p>Ref.: <b>FED-440A38</b> (Ref. Fedesa®: 440A38)</p>	19'60€
NUEVO	 <p>Muelle Fedesa®</p> <p>Ref.: <b>FED-440A39</b> (Ref. Fedesa®: 440A39)</p>	16'80€
NUEVO	 <p>Muelle Fedesa®</p> <p>Ref.: <b>FED-440A41</b> (Ref. Fedesa®: 440A41)</p>	15'80€
NUEVO	 <p>Muelle Fedesa®</p> <p>Ref.: <b>FED-440A64</b> (Ref. Fedesa®: 440A64)</p>	16'80€
NUEVO	 <p>Muelle Fedesa®</p> <p>Ref.: <b>FED-440B06</b> (Ref. Fedesa®: 440B06)</p>	15'80€

## MOTORES ELEVADORES PARA SILLONES FEDESA®

Motores elevadores para sillones Fedesa®

RUMAR







	Descripción	Observaciones
NUEVO	 <p>Motor subida Fedesa® <b>SH80 IP40</b></p> <p>Ref.: <b>FED-430A33</b></p>	 <p>528'00€*</p> <p>*Sin descuento</p>

**PRÓXIMAMENTE NUEVAS REFERENCIAS ¡CONSÚLTANOS!**

## VARIOS REPUESTOS PARA SILLONES FEDESA®

Varios repuestos para sillones Fedesa®

RUMAR

	Descripción	Observaciones
NUEVO	 <p>Apoya instrumentos bandeja Midway-2</p> <p>Ref.: <b>FED-038A06</b> (Ref. Fedesa®: 038A06)</p> <p><b>29'80€</b></p>	
NUEVO	 <p>Brazo colibrí / pértiga Fedesa®</p> <p>Ref.: <b>FED-520A51</b> (Ref. Fedesa®: 520A51)</p> <p><b>18'00€</b></p>	También montado en referencias: 4031B, 4027B, 4028B y 4029B)
NUEVO	 <p>Acoplamiento desagüe Fedesa® encimera escupidera</p> <p>Ref.: <b>FED-2332C04</b> (Ref. Fedesa®: 2332C04)</p> <p><b>17'80€</b></p>	
NUEVO	 <p>Filtro sólido taza cestilla Fedesa®</p> <p>Ref.: <b>FED-520A14</b> (Ref. Fedesa®: 520A14)</p> <p><b>8'80€</b></p>	
NUEVO	 <p>Cubre filtro sólido cestilla Fedesa®</p> <p>Ref.: <b>FED-4002Z05</b> (Ref. Fedesa®: 4002Z05)</p> <p><b>7'80€</b></p>	
NUEVO	 <p>Portabandeja ranurado Fedesa®</p> <p>Ref.: <b>FED-4014E05</b> (Ref. Fedesa®: 4014E05)</p> <p><b>8'00€</b></p>	









**OTROS REPUESTOS FEDESA ¡CONSÚLTANOS!**

PRÓXIMAMENTE NUEVAS REFERENCIAS ¡CONSÚLTANOS!

## PISTONES PARA SILLONES FEDESA®

Pistones para sillones Fedesa®

RUMAR

	Descripción	Observaciones
NUEVO	 <p>Pistón para sillones Fedesa®, <b>350 N</b></p> <p>Ref.: <b>FED-500A06</b></p> <p><b>48<sup>80</sup>€</b></p>	
NUEVO	 <p>Pistón para sillones Fedesa®, <b>1500 N</b></p> <p>Ref.: <b>FED-500A21</b> (Ref. Fedesa®: 500A21)</p> <p><b>145<sup>80</sup>€</b></p>	
NUEVO	 <p>Pistón para sillones Fedesa®, <b>2700 N</b></p> <p>Ref.: <b>FED-500A24</b> (Ref. Fedesa®: 500A24)</p> <p><b>80<sup>80</sup>€</b></p>	
NUEVO	 <p>Pistón para sillones Fedesa®, <b>2100 N</b></p> <p>Ref.: <b>FED-500A40</b> (Ref. Fedesa®: 500A40)</p> <p><b>64<sup>80</sup>€</b></p>	
NUEVO	 <p>Pistón para sillones Fedesa®, <b>2500 N</b></p> <p>Ref.: <b>FED-500A41</b> (Ref. Fedesa®: 500A41)</p> <p><b>60<sup>80</sup>€</b></p>	
NUEVO	 <p>Pieza palanca pistones sillones Fedesa®</p> <p>Ref.: <b>FED-0001</b></p> <p><b>6<sup>80</sup>€</b></p>	
NUEVO	 <p>Cabeza disparo pistones para sillones Fedesa®</p> <p>Ref.: <b>FED-0002</b></p> <p><b>9<sup>80</sup>€</b></p>	<b>Diámetro rosca:</b> 10mm
NUEVO	 <p>Cabeza disparo pistones para sillones Fedesa®</p> <p>Ref.: <b>FED-0003</b></p> <p><b>6<sup>80</sup>€</b></p>	<b>Diámetro rosca:</b> 8mm

NOVEDAD

PSD

## ▶ PISTONES PARA SILLONES DENTALES

- Pistones para sillones Fedesa®
- Pistones para sillones Sirona®

**PRÓXIMAMENTE NUEVAS REFERENCIAS ¡CONSÚLTANOS!**

## PISTONES PARA SILLONES FEDESA®

Pistones para sillones Fedesa®

RUMAR

Para pistones para sillones Fedesa®  
Ver sección Fedesa®: Pistones para sillones Fedesa®

## PISTONES PARA SILLONES SIRONA®

Pistones para sillones Sirona®

RUMAR

### Descripción

Pistón brazo lámpara Sirona® Sirolux, **460 N**

Ref.: **SIR-5856757** (Ref. Sirona®: 5856757)

**98<sup>00</sup>€**

### Observaciones

NUEVO



RLF

## ▶ REPUESTOS LÁMPARAS FARO®









- Repuestos lámpara **Alya**
- Repuestos lámpara **Maia**
- Repuestos lámpara **EDI**
- Repuestos lámpara **Forma** y otras

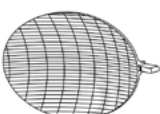
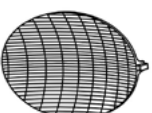

# REPUESTOS LÁMPARAS ALYA

Repuestos Lámparas Faro® Alya, Alya-TheiaTech, Alya CAM









	Descripción	Características
	<p>Palanca interruptor lámpara <b>Alya</b></p> <p><b>Ref.: 80-010108</b> (Ref. Faro®: SP310108)</p> <p><b>20<sup>80€</sup></b></p>	
	<p>Pareja reflectores lámpara <b>Alya</b> <b>(N/S&lt;10LD012150)</b></p> <p><b>Ref.: 80-010025</b> (Ref. Faro®: SP310025)</p> <p><b>92<sup>80€</sup></b></p>	
	<p>Pareja reflectores lámpara <b>Alya</b> <b>(N/S&gt;10LD012150)</b></p> <p><b>Ref.: 80-010025006</b> (Ref. Faro®: SP310025006)</p> <p><b>92<sup>80€</sup></b></p>	
	<p>Kit soportes y asas blancas (derecha + izquierda) lámpara <b>Alya (Todas)</b></p> <p><b>Ref.: 80-010390006</b> (Ref. Faro®: SP310390006= SP310352006+SP310370006)</p> <p><b>169<sup>80€</sup></b></p>	
	<p>Kit soportes asas blancas (derecha + izquierda) lámpara <b>Alya</b> <b>(N/S&gt;11LD005228)</b></p> <p><b>Ref.: 80-010352006</b> (Ref. Faro®: SP310352006)</p> <p><b>43<sup>80€</sup></b></p>	
	<p>Kit asas blancas (derecha + izquierda) lámpara <b>Alya</b> <b>(N/S&gt;11LD005228)</b></p> <p><b>Ref.: 80-010370006</b> (Ref. Faro®: SP310370006)</p> <p><b>131<sup>80€</sup></b></p>	
	<p>Interruptor completo lámpara <b>Alya</b></p> <p><b>Ref.: 80-010102</b> (Ref. Faro®: SP310102)</p> <p><b>75<sup>80€</sup></b></p>	
 <p>80-010285 80-010125B</p>	<p>Kit Grupo LED + Placa electrónica <u>con interruptor</u> y carcasa blanca para lámpara <b>Alya</b></p> <p><b>Ref.: 80-010700</b> (Ref. Faro®: SP510700 = SP510285 + SP510125)</p> <p><b>583<sup>80€</sup></b></p>	<p>N/S&lt;10LD012150 <b>NO</b> válido N/S&gt;10LD012151 Válido</p>
 <p>80-010285 80-010130B</p>	<p>Kit Grupo LED + Placa electrónica <u>con sensor</u> y carcasa blanca para lámpara <b>Alya</b></p> <p><b>Ref.: 80-010701</b> (Ref. Faro®: SP510701 = SP510285 + SP510130)</p> <p><b>583<sup>80€</sup></b></p>	<p>N/S&lt;10LD012150 <b>NO</b> válido N/S&gt;10LD012151 Válido</p>

BAJO PEDIDO

OTRAS REFERENCIAS DISPONIBLES CONSÚLTANOS



	Descripción	Características
	<p>Grupo LED lámpara <b>Alya</b> (15LD005044&lt;N/S&lt;17LD010112)</p> <p>Ref.: <b>80-010435</b> (Ref. Faro®: SP310435)</p>	<p>Recomendamos upgrade con Kit <b>80-010700</b> (con interruptor) o <b>80-010701</b> (con sensor).</p> <p>434<sup>80</sup>€</p>
	<p>Grupo LED lámpara <b>Alya</b> (N/S&gt;17LD010113)</p> <p>Ref.: <b>80-010285</b> (Ref. Faro®: SP510285)</p>	<p>Ver también: Kit <b>80-010700</b> (con interruptor) o <b>80-010701</b> (con sensor).</p> <p>449<sup>80</sup>€</p> <p>HASTA AGOTAR</p>
	<p>Placa electrónica con sensor y carcasa gris lámpara <b>Alya</b> (N/S&lt;10LD012150)</p> <p>Ref.: <b>80-010130</b> (Ref. Faro®: SP310130)</p>	<p>418<sup>80</sup>€</p> <p>BAJO PEDIDO</p>
	<p>Placa electrónica con sensor y carcasa "blanca" lámpara <b>Alya</b> (15LD005044&lt;N/S&lt;17LD010112)</p> <p>Ref.: <b>80-010485006</b> (Ref. Faro®: SP310485006)</p>	<p>Recomendamos upgrade con <b>80-010701</b> (con sensor).</p> <p>418<sup>80</sup>€</p>
	<p>Placa electrónica con interruptor y carcasa "blanca" lámpara <b>Alya</b> (N/S&gt;17LD010113)</p> <p>Ref.: <b>80-010125B</b> (Ref. Faro®: SP510125)</p>	<p>Ver también: Kit <b>80-010700</b> (con interruptor)</p> <p>324<sup>80</sup>€</p>
	<p>Placa electrónica con sensor y carcasa "blanca" lámpara <b>Alya</b> (N/S&gt;17LD010113)</p> <p>Ref.: <b>80-010130B</b> (Ref. Faro®: SP510130B)</p>	<p>Ver también: Kit <b>80-010701</b> (con sensor).</p> <p>421<sup>80</sup>€</p> <p>BAJO PEDIDO</p>

OTRAS REFERENCIAS DISPONIBLES CONSÚLTANOS

# REPUESTOS LÁMPARAS MAIA

Repuestos Lámparas Faro® Maia

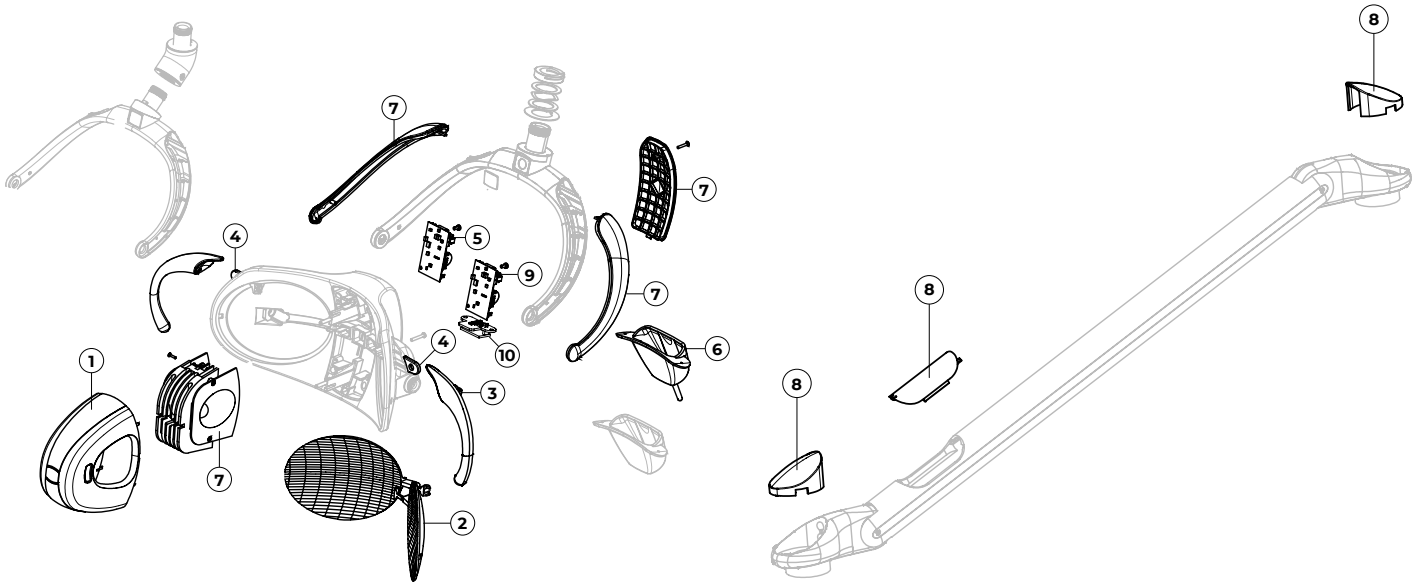

NUEVO



## Descripción

Kit reparación Faro lámpara MAIA con interruptor (N/S>15LD011296)

### Incluye:

- |               |   |
|---------------|---|
| 1. SP320901   | Carcasa grupo LED   |
| 2. 80-030902  | Pareja de reflectores (Ref. Faro: SP320902)                   |
| 3. 80-030904  | Kit asas (derecha + izquierda) (Ref. Faro: SP320904)          |
| 4. 80-030905  | Kit soportes (derecha + izquierda) (Ref. Faro: SP320905)      |
| 5. 80-030906A | Placa electrónica (N/S>15LD011296) (Ref. Faro: SP320906A)     |
| 6. 80-030907A | Interruptor c/palanca (N/S>15LD011296) (Ref. Faro: SP320907A) |
| 7. 80-030911  | Kit carcasas cabeza (Ref. Faro: SP320911)                     |
| 8. SP320912   | Kit cubiertas brazo   |
| 9. SP320926   | A Placa electrónica Maia*sensor (N/S>15LD011296)              |
| 10. SP320927  | Sensor Maia   |
| 80-030095     | Cable de grupo LED a placa electrónica (Ref. Faro SP310095)   |
| SP310104      | Buzzer  |
| SP320085      | Cable PCB a fuente de alimentación                            |
| SP310139      | Cable PCB a lámpara set                                       |

Ref.: 80-030900

788<sup>00</sup>€

## Características



Palanca interruptor lámpara **Maia**

Ref.: 80-030908 (Ref. Faro®: SP320908/5)

3<sup>90</sup>€

1 Unidad









Interruptor con palanca lámpara **Maia**  
(N/S>15LD011296)

Ref.: 80-030907 (Ref. Faro®: SP320907)

99<sup>80</sup>€

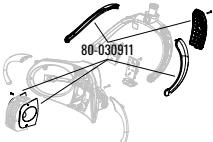
OTRAS REFERENCIAS DISPONIBLES CONSÚLTANOS

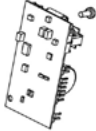
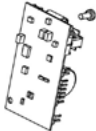
	Descripción	Características
	<p>Interruptor con palanca lámpara <b>Maia</b> (N/S&gt;15LD011296)</p> <p><b>Ref.: 80-030907A</b> (Ref. Faro®: SP320907A)</p> <p><b>99<sup>80</sup>€</b></p>	
	<p>Pareja reflectores lámpara <b>Maia</b></p> <p><b>Ref.: 80-030902</b> (Ref. Faro®: SP320902)</p> <p><b>88<sup>00</sup>€</b></p>	
	<p>Kit asas (derecha + izquierda) lámpara <b>EDI y Maia</b></p> <p><b>Ref.: 80-026365</b> (Ref. Faro®: SP306365; SP320904)</p> <p><b>101<sup>80</sup>€</b></p>	
	<p>Kit soportes (derecha + izquierda) lámpara <b>Maia</b></p> <p><b>Ref.: 80-030905</b> (Ref. Faro®: SP320905)</p> <p><b>9<sup>80</sup>€</b></p>	Pack 1 pareja
	<p>Kit carcasa cabeza lámpara <b>Maia</b></p> <p><b>Ref.: 80-030911</b></p> <p><b>74<sup>80</sup>€</b></p>	
	<p>Cable de grupo LED a placa electrónica lámparas <b>Maia y Alya</b></p> <p><b>Ref.: 80-030095</b> (Ref. Faro®: 310095)</p> <p><b>31<sup>80</sup>€</b></p>	
	<p>Grupo LED lámpara <b>Maia</b></p> <p><b>Ref.: 80-030903</b> (Ref. Faro®: SP320903)</p> <p><b>324<sup>80</sup>€</b></p>	
	<p>Placa electrónica lámpara <b>Maia</b> (N/S&lt;15LD011296)</p> <p><b>Ref.: 80-030906</b> (Ref. Faro®: SP320906)</p> <p><b>264<sup>80</sup>€</b></p>	
	<p>Placa electrónica lámpara <b>Maia</b> (N/S&gt;15LD011296)</p> <p><b>Ref.: 80-030906A</b> (Ref. Faro SP320906A)</p> <p><b>312<sup>80</sup>€</b></p>	

NUEVO









OTRAS REFERENCIAS DISPONIBLES CONSÚLTANOS

SI NO ENCUENTRAS EL REPUESTO QUE BUSCAS, ¡CONSÚLTANOS!  
Precios: impuestos, portes y mano de obra no incluidos.





# REPUESTOS LÁMPARAS EDI

## Repuestos Lámparas Faro® Edi

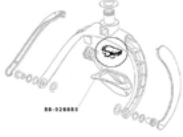

Descripción		Características
	Interruptor bipolar lámpara <b>EDI</b>  <b>Ref.: 80-029005</b> (Ref. Faro®: SP409005)	28 <sup>80</sup> €
	Reflector lámpara <b>EDI</b>  <b>Ref.: 80-026001</b> (Ref. Faro®: 306001)	1 Unidad  134 <sup>80</sup> €
	Protección frontal lámpara <b>EDI</b>  <b>Ref.: 80-026029</b> (Ref. Faro®: 306029)	67 <sup>80</sup> €
	Protector bombilla lámpara <b>EDI</b>  <b>Ref.: 80-026027</b> (Ref. Faro®: 306027)	23 <sup>80</sup> €
	Kit soportes (derecha + izquierda) lámpara <b>EDI</b>  <b>Ref.: 80-026364</b> (Ref. Faro®: SP306364=SP306035+SP306038)	44 <sup>80</sup> €
	Kit asas (derecha + izquierda) lámpara <b>EDI</b> y <b>Maia</b>  <b>Ref.: 80-026365</b> (Ref. Faro®: SP306365; SP320904)	101 <sup>80</sup> €
	Protector térmico lámpara <b>EDI</b>  <b>Ref.: 80-026032</b> (Ref. Faro®: SP306032)	13 <sup>80</sup> €
	Regulador intensidad lámpara <b>EDI</b>  <b>Ref.: 80-026053</b> (Ref. Faro®: SP306053)	34 <sup>80</sup> €
 <p>Imagen no disponible</p>	Asa inferior lámpara <b>EDI</b>  <b>Ref.: 80-026076</b> (Ref. Faro®: SP306076)	34 <sup>80</sup> €

OTRAS REFERENCIAS DISPONIBLES CONSÚLTANOS

	Descripción	Características
	<p>Ventilador lámpara <b>EDI</b></p> <p>Ref.: <b>80-026079</b> (Ref. Faro®: SP306079)</p>	<p><b>55</b> <sup>80</sup>€</p>
	<p>Electrónica ventilador lámpara <b>EDI</b></p> <p>Ref.: <b>80-026080</b> (Ref. Faro®: SP306080)</p>	<p><b>36</b> <sup>80</sup>€</p>
	<p>Porta lámparas lámpara <b>EDI</b></p> <p>Ref.: <b>80-026019</b> (Ref. Faro®: SP306019)</p>	<p><b>20</b> <sup>80</sup>€</p>
	<p>Bombilla 17V 95W lámpara <b>EDI // Castellini® Venus</b></p> <p>Ref.: <b>80-021122</b> (Ref. Faro®: SP401122)</p>	<p><b>14</b> <sup>80</sup>€</p>
	<p>Brazo trasero, 75 cm, lámpara <b>EDI</b> (RAL 9016*)</p> <p>Ref.: <b>80-026262</b></p>	<p>*Otro RAL consultar.</p> <p><b>422</b> <sup>80</sup>€</p>

NUEVO









OTRAS REFERENCIAS DISPONIBLES CONSÚLTANOS

SI NO ENCUENTRAS EL REPUESTO QUE BUSCAS, ¡CONSÚLTANOS!  
 Precios: impuestos, portes y mano de obra no incluidos.

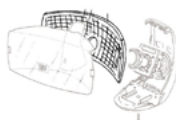
# REPUESTOS LÁMPARAS FORMA

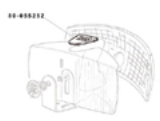
Repuestos Lámparas Faro® Forma, S90, SC y TS90



	Descripción	Características
	Bombilla OSRAM 24V 150W casquillo cerámico  <b>Ref.: 80-64643FDS</b> (Ref. Faro®: SP406022)	23 <sup>80</sup> €
	Interruptor unipolar con transformador lámparas <b>Forma</b>  <b>Ref.: 80-058116</b> (Ref. Faro®: SP408116)	18 <sup>80</sup> €
	Reflector parabólico lámparas <b>Forma 2000/90</b>  <b>Ref.: 80-055255</b> (Ref. Faro®: SP305255)	331 <sup>80</sup> € <span style="float: right; background-color: #4CAF50; color: white; padding: 2px 5px;">BAJO PEDIDO</span>
	Plexiglas protección frontal lámparas <b>Forma 90</b>  <b>Ref.: 80-058013</b> (Ref. Faro®: SP408013)	78 <sup>80</sup> €
	Plexiglas protección frontal lámparas <b>Forma 2000</b>  <b>Ref.: 80-058858</b> (Ref. Faro®: SP408858)	54 <sup>80</sup> €
	Baffle blanco lámparas <b>Forma 2000/90</b>  <b>Ref.: 80-055252</b> (Ref. Faro®: SP305252)	13 <sup>80</sup> € <span style="float: right; background-color: #FFEB3B; padding: 2px 5px;">HASTA AGOTAR</span>
	Regulador intensidad lámparas <b>Forma 2000/90</b>  <b>Ref.: 80-058877</b> (Ref. Faro®: SP408877)	16 <sup>80</sup> €
	Electrónica con ventilador lámparas <b>Forma 2000/90</b>  <b>Ref.: 80-055284</b> (Ref. Faro®: SP305284)	118 <sup>00</sup> €
	Porta lámparas lámparas <b>Forma 2000/90</b>  <b>Ref.: 80-058005</b> (Ref. Faro®: SP408005)	44 <sup>80</sup> €

OTRAS REFERENCIAS DISPONIBLES CONSÚLTANOS

RAS

## ▶ REPUESTOS AUTOCLAVES Y SELLADORAS



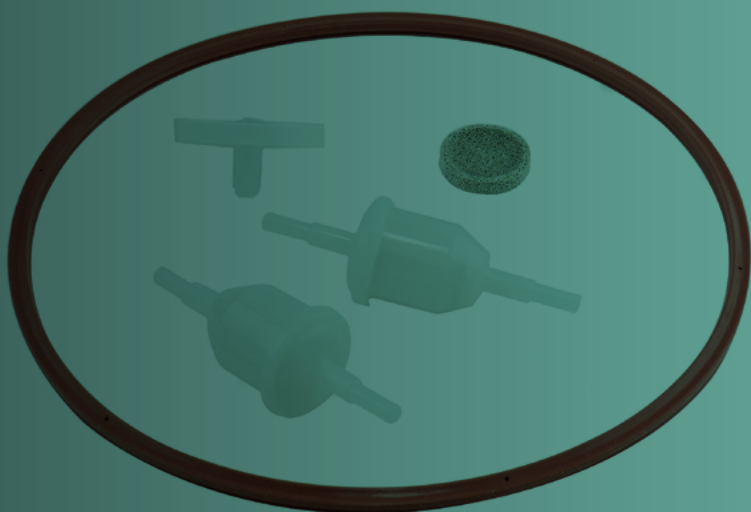
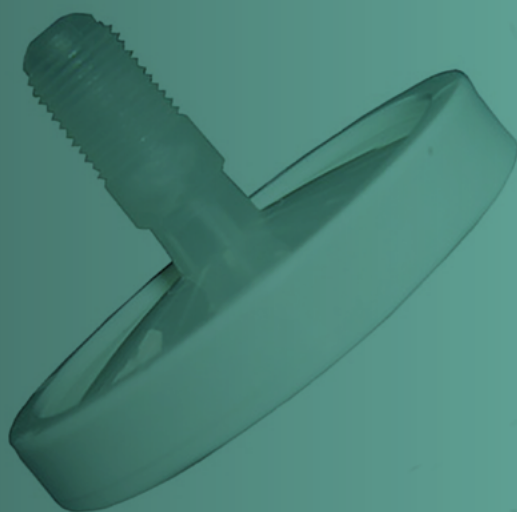



## Repuestos Autoclaves / Repuestos Autoclaves FARO®





	Descripción	Características
	Kit mantenimiento autoclave Faro® SK07, Moon, Step y Easy-R  <b>Ref.: 80-302705</b> (Ref. Faro®: SP742705)	<b>Incluye:</b> 2x Filtros agua (Ref. Faro® 707175X2) Junta puerta (Ref. Faro® 708014) Filtro caldera (Ref. Faro® 737068) Tubos carga / descarga (Ref. Faro® 742589) Filtro bacteriológico (Ref. Faro® 742631)
	Junta puerta autoclave Faro® SK07, Moon, Step, Easy-R, Just  <b>Ref.: 80-308014</b> (Ref. Faro®: SP708014)	<b>46<sup>80€</sup></b>
	Junta puerta autoclave Faro® Nisea  <b>Ref.: 80-300067</b> (Ref. Faro®: SP750067)	<b>23<sup>80€</sup></b>
	Maneta autoclave Faro® SK07  <b>Ref.: 80-302526</b> (Ref. Faro® SP742526)	<b>74<sup>80€</sup></b>
	Filtro agua autoclave Faro® SK07 (pack: 2 uds)  <b>Ref.: 80-307175</b> (Ref. Faro®: SP707175)	<b>21<sup>80€</sup></b>
	Tubos de carga y descarga autoclaves Faro®  <b>Ref.: 80-302592</b> (Ref. Faro®: SP742592)	<b>35<sup>80€</sup></b>
	Filtro bacteriológico autoclaves "todos los modelos"  <b>Ref.: 70-0004</b> (Ref. Faro®: 742631/3, 737079)	<b>18<sup>00€</sup></b>

OTRAS REFERENCIAS DISPONIBLES CONSÚLTANOS

SI NO ENCUENTRAS EL REPUESTO QUE BUSCAS, ¡CONSÚLTANOS!  
 Precios: impuestos, portes y mano de obra no incluidos.

Filtros bacteriológicos autoclaves

Conexión Abierta / Open End		Descripción
	Filtro bacteriológico autoclave <b>"ROSCA LARGA"</b> Utilizado en autoclaves: Cominox®, Mocom®, Tecnogaz®, W&H® (algunos modelos), Satelec® Acteon®, NSK® (algunos modelos)	Medidas conexión: 1/8" x 25mm
<b>Ref.: 70-0004</b>	<b>18<sup>00</sup>€</b>	
	Filtro bacteriológico autoclave <b>"ROSCA CORTA"</b> Utilizado en autoclaves: Euronda®, Icanclave®, W&H® (algunos modelos), NSK® (algunos modelos)	Medidas conexión: 1/8" x 18mm
<b>Ref.: 70-0008</b>	<b>18<sup>00</sup>€</b>	

Repuestos Selladoras: Repuestos Selladoras FARO®



Descripción	Características
 Cuchilla selladora Sella II <b>(con soporte)</b>	
<b>Ref.: 80-700301</b> (Ref. Faro®: SP700301)	<b>54<sup>80</sup>€</b>
 Resistencia selladora Sella II <b>(con junta)</b>	
<b>Ref.: 80-700303</b> (Ref. Faro®: 700303)	<b>108<sup>00</sup>€</b>
 Cuchilla selladora SL13 <b>(sin soporte)</b>	
<b>Ref.: 80-700353</b> (Ref. Faro®: SP700353)	<b>66<sup>80</sup>€</b>

NUEVO

OTRAS REFERENCIAS DISPONIBLES CONSÚLTANOS

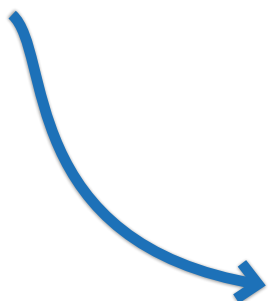

RBV

## ▶ REPUESTOS BOMBAS DE VACÍO

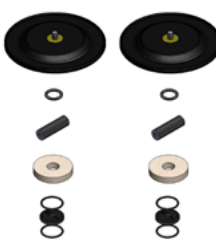
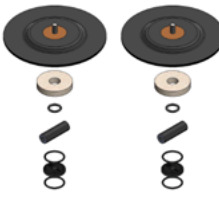

**Consúltanos**  
por el que necesitas para tu  
**autoclave**

Kits de mantenimiento

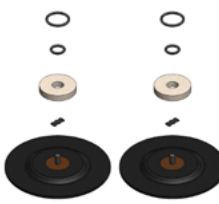
	Descripción	Observaciones
	<p>Kit de mantenimiento de <b>H5 y H5P3</b></p> <p><b>Suministro incluye:</b></p> <ul style="list-style-type: none"> <li>- <b>Membrana:</b> H5, EPDM 02 con tornillo (1ud.)</li> <li>- <b>Anillos tóricos:</b> 16,5x1,5mm, silicona roja (4uds.)</li> <li>- <b>Obturador:</b> H5, FPM (2Uds.)</li> </ul> <p><b>Ref.: 08-H5001</b> <span style="float: right;"><b>70<sup>80</sup>€</b></span></p>	
	<p>Kit completo de mantenimiento <b>EVO10</b></p> <p><b>Suministro incluye:</b></p> <ul style="list-style-type: none"> <li>- <b>Membrana:</b> EVO10, EPDM 02, con tornillo (2 uds.)</li> <li>- <b>Anillos tóricos:</b> 9,50x2,00mm, EPDM (4 uds.)</li> <li>- <b>Grupo válvula obturador:</b> EVO sin anilla (6 uds.)*</li> <li>- <b>Tubo:</b> EPDM EVO (1 ud.)</li> <li>- <b>Filtro silenciador:</b> EVO10 (2 uds.)</li> </ul> <p>* Este grupo válvula obturador equivale al "obturador EVO FPM + anillo tórico 17,10x1,60 EPDM" del otro kit, pero esta versión es más duradera y es la que recomienda el fabricante.</p> <p><b>Ref.: 08-EVO10001</b> <span style="float: right;"><b>289<sup>80</sup>€</b></span></p>	
	<p>Kit completo de mantenimiento <b>EVO30</b></p> <p><b>Suministro incluye:</b></p> <ul style="list-style-type: none"> <li>- <b>Membrana:</b> EVO30, EPDM, con tornillo (2 uds.)</li> <li>- <b>Anillos tóricos:</b> 9,50x2,00mm, EPDM (4 uds.)</li> <li>- <b>Grupo válvula obturador:</b> EVO sin anilla (6 uds.)*</li> <li>- <b>Tubo:</b> EPDM EVO (1 ud.)</li> <li>- <b>Filtro silenciador:</b> EVO30 (2 uds.)</li> </ul> <p><b>Ref.: 08-EVO30001</b> <span style="float: right;"><b>324<sup>80</sup>€</b></span></p>	
	<p>Kit de mantenimiento <b>HX10P3 05</b></p> <p><b>Suministro incluye:</b></p> <ul style="list-style-type: none"> <li>- <b>Membrana:</b> EVO10, EPDM, con tornillo (2 uds.)</li> <li>- <b>Anillos tóricos:</b> 9,50 x 2,00mm, EPDM (4 uds.)</li> <li>- <b>Anillos tóricos:</b> 16,50 x 1,50mm, silicona roja (4 uds.)</li> <li>- <b>Obturador:</b> H10, FPM (4 uds.)</li> <li>- <b>Filtro silenciador:</b> EVO10 (2 uds.)</li> </ul> <p><b>Ref.: 08-HX10P3001</b> <span style="float: right;"><b>180<sup>00</sup>€</b></span></p>	
	<p>Kit de mantenimiento <b>HX30P3 05 Serie</b></p> <p><b>Suministro incluye:</b></p> <ul style="list-style-type: none"> <li>- <b>Membrana:</b> EVO30, EPDM, con tornillo (2 uds.)</li> <li>- <b>Anillos tóricos:</b> 17 x 2,00mm, EPDM (4 uds.)</li> <li>- <b>Anillos tóricos:</b> 9,50 x 2,00mm, EPDM (4 uds.)</li> <li>- <b>Obturador:</b> EVO, FPM (4 uds.)</li> <li>- <b>Filtro silenciador:</b> EVO30 (2 uds.)</li> </ul> <p><b>Ref.: 08-HX30P3001</b> <span style="float: right;"><b>239<sup>80</sup>€</b></span></p>	

JRJ

## ▶ JERINGAS Y REPUESTOS JERINGAS

- Jeringas **Luzzani**® y sus repuestos
- Jeringas **FARO**® y sus repuestos
- Jeringas económicas
- Puntas compatibles jeringas



RUMAR

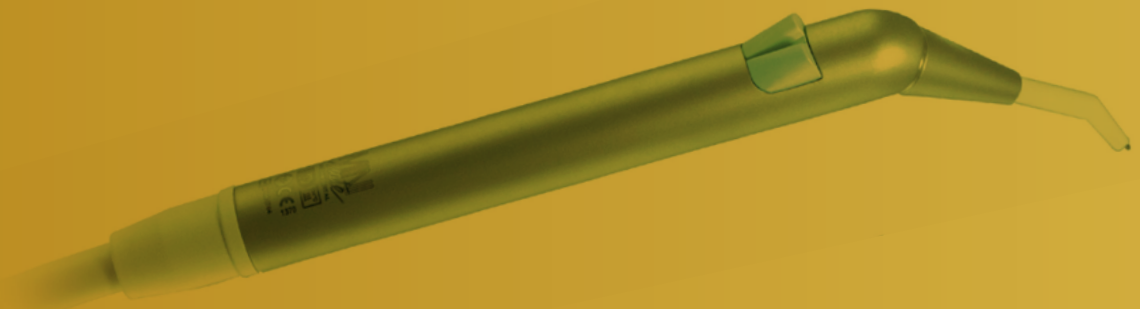
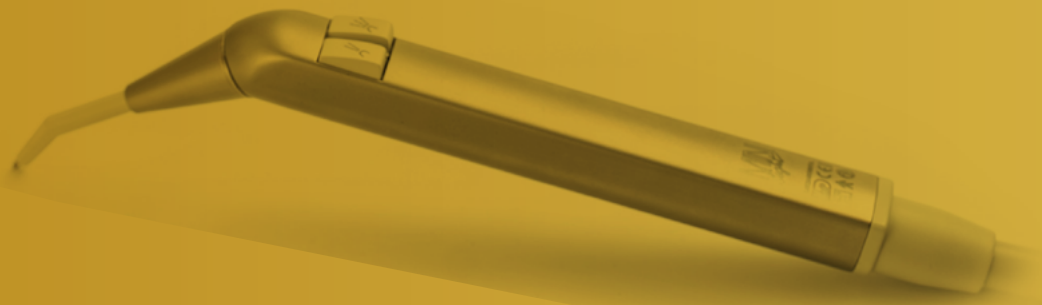



Consulta por las  
puntas desechables

**Pro-Tip TURBO**

## Jeringas Luzzani® Minibright



### Conexión Abierta / Open End

Jeringa Minibright 6F con luz  
Conexión equipo: Abierta

### Características

**Longitud:** 170cm  
**Forma:** Recta  
**Color:** Gris (RAL 7038)  
**Material:** Acero



Ref.: **39-3151**

**448<sup>00</sup>€**





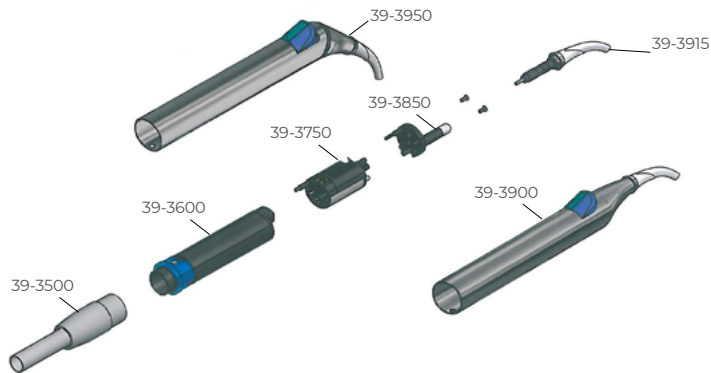

TODOS LOS REPUESTOS JERINGAS LUZZANI® CONSULTE PRECIOS Y DESPIECES

SI NO ENCUENTRAS EL REPUESTO QUE BUCAS, ¡CONSÚLTANOS!  
Precios: impuestos, portes y mano de obra no incluidos.

Consulta por las  
puntas desechables  
**Pro-Tip TURBO**

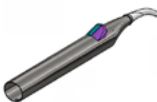

Repuestos Jeringas Minibrigh: F6 y EFFE 6 BEI

	Descripción	Características
	Punta jeringa Minibrigh  <b>Ref.: 39-3915</b>	<b>22<sup>80</sup>€</b>
	Kit completo reparación Minibrigh  <b>Ref.: 39-3000</b>	<b>52<sup>80</sup>€</b>
	Kit completo anillos tóricos Minibrigh  <b>Ref.: 39-3001</b>	<b>16<sup>80</sup>€</b>
	Cabeza completa Minibrigh  <b>Ref.: 39-3750</b>	<b>180<sup>80</sup>€</b>
	LED Minibrigh  <b>Ref.: 39-3850</b>	<b>67<sup>80</sup>€</b>
	Cuerpo central Minibrigh  <b>Ref.: 39-3600</b>	<b>125<sup>80</sup>€</b>
	Manguera completa Minibrigh  <b>Ref.: 39-3500</b>	Longitud: 170cm Color: Gris (RAL 7038)  <b>101<sup>80</sup>€</b>
	Carcasa completa Minibrigh  <b>Ref.: 39-3900</b>	<b>159<sup>80</sup>€</b>

TODOS LOS REPUESTOS JERINGAS LUZZANI® CONSULTE PRECIOS Y DESPIECES





Consulta por las  
puntas desechables  
**Pro-Tip TURBO**

Jeringas Luzzani® Minilight: **Conexión Abierta / Open End**



Conexión Abierta / Open End		Características
	Jeringa Minilight 3F. <b>Conexión equipo:</b> Abierta  <b>Ref.: 39-12521</b>	<b>Longitud:</b> 170cm <b>Forma:</b> Recta <b>Color:</b> Gris (RAL 7038) <b>Material:</b> Acero  <b>268'00€</b>
	Jeringa Minilight 3F. <b>Conexión equipo:</b> Abierta  <b>Ref.: 39-12621</b>	<b>Longitud:</b> 170cm <b>Forma:</b> Angulada <b>Color:</b> Gris (RAL 7038) <b>Material:</b> Acero  <b>274'80€</b>
	Jeringa Minilight 6F. <b>Conexión equipo:</b> Abierta  <b>Ref.: 39-11521</b>	<b>Longitud:</b> 170cm <b>Forma:</b> Recta <b>Color:</b> Gris (RAL 7038) <b>Material:</b> Acero  <b>368'00€</b>
	Jeringa Minilight 6F. <b>Conexión equipo:</b> Abierta  <b>Ref.: 39-11621</b>	<b>Longitud:</b> 170cm <b>Forma:</b> Angulada <b>Color:</b> Gris (RAL 7038) <b>Material:</b> Acero  <b>384'80€</b>

Jeringas Luzzani® Minilight: **Conector a equipo Cefla® (Desde 2006)**













Conector a equipo Cefla® (desde 2006)		Descripción
	Jeringa Minilight 3F <b>Conexión equipo Cefla® (desde 2006):</b> <b>Anthos®:</b> A3, A5, A6, A7, A9, L6, L9, R7; <b>Stern Weber®:</b> S200, S220TR S250, S280TRC, S300, 320TR, S320TR, S380TRC; <b>Castellini®:</b> SKEMA 5, SKEMA 6, SKEMA 8  <b>Ref.: 39-12521C1</b>	<b>Longitud:</b> 120cm <b>Forma:</b> Recta <b>Color:</b> Gris (RAL 7038) <b>Material:</b> Acero  <b>396'80€</b>
	Jeringa Minilight 3F <b>Conexión equipo Cefla® (desde 2006):</b> <b>Anthos®:</b> A3, A5, A6, A7, A9, L6, L9, R7; <b>Stern Weber®:</b> S200, S220TR S250, S280TRC, S300, 320TR, S320TR, S380TRC; <b>Castellini®:</b> SKEMA 5, SKEMA 6, SKEMA 8  <b>Ref.: 39-12521C2</b>	<b>Longitud:</b> 135cm <b>Forma:</b> Recta <b>Color:</b> Gris (RAL 7038) <b>Material:</b> Acero  <b>396'80€</b>
	Jeringa Minilight 3F <b>Conexión equipo Cefla® (desde 2006):</b> <b>Anthos®:</b> A3, A5, A6, A7, A9, L6, L9, R7; <b>Stern Weber®:</b> S200, S220TR S250, S280TRC, S300, 320TR, S320TR, S380TRC; <b>Castellini®:</b> SKEMA 5, SKEMA 6, SKEMA 8  <b>Ref.: 39-12621C1</b>	<b>Longitud:</b> 120cm <b>Forma:</b> Angulada <b>Color:</b> Gris (RAL 7038) <b>Material:</b> Acero  <b>418'00€</b>

TODOS LOS REPUESTOS JERINGAS LUZZANI® CONSULTE PRECIOS Y DESPIECES

SI NO ENCUENTRAS EL REPUESTO QUE BUSCAS, ¡CONSÚLTANOS!  
Precios: impuestos, portes y mano de obra no incluidos.

## Conector a equipo Cefla® (desde 2006)

## Descripción









		<p>Jeringa Minilight 3F</p> <p><b>Conexión equipo Cefla® (desde 2006):</b>  <b>Anthos®:</b> A3, A5, A6, A7, A9, L6, L9, R7; <b>Stern Weber®:</b> S200, S220TR S250, S280TRC, S300, 320TR, S320TR, S380TRC;  <b>Castellini®:</b> SKEMA 5, SKEMA 6, SKEMA 8</p>	<p><b>Longitud:</b> 135cm  <b>Forma:</b> Angulada  <b>Color:</b> Gris (RAL 7038)  <b>Material:</b> Acero</p>	
		<b>Ref.: 39-12621C2</b>	<b>418<sup>00</sup>€</b>	
		<p>Jeringa Minilight 6F</p> <p><b>Conexión equipo Cefla® (desde 2006):</b>  <b>Anthos®:</b> A3, A5, A6, A7, A9, L6, L9, R7; <b>Stern Weber®:</b> S200, S220TR S250, S280TRC, S300, 320TR, S320TR, S380TRC;  <b>Castellini®:</b> SKEMA 5, SKEMA 6, SKEMA 8</p>	<p><b>Longitud:</b> 120cm  <b>Forma:</b> Recta  <b>Color:</b> Gris (RAL 7038)  <b>Material:</b> Acero</p>	
		<b>Ref.: 39-11521C1</b>	<b>539<sup>00</sup>€</b>	<b>BAJO PEDIDO</b>
		<p>Jeringa Minilight 6F</p> <p><b>Conexión equipo Cefla® (desde 2006):</b>  <b>Anthos®:</b> A3, A5, A6, A7, A9, L6, L9, R7; <b>Stern Weber®:</b> S200, S220TR S250, S280TRC, S300, 320TR, S320TR, S380TRC;  <b>Castellini®:</b> SKEMA 5, SKEMA 6, SKEMA 8</p>	<p><b>Longitud:</b> 135cm  <b>Forma:</b> Recta  <b>Color:</b> Gris (RAL 7038)  <b>Material:</b> Acero</p>	
		<b>Ref.: 39-11521C2</b>	<b>539<sup>00</sup>€</b>	<b>BAJO PEDIDO</b>
		<p>Jeringa Minilight 6F</p> <p><b>Conexión equipo Cefla® (desde 2006):</b>  <b>Anthos®:</b> A3, A5, A6, A7, A9, L6, L9, R7; <b>Stern Weber®:</b> S200, S220TR S250, S280TRC, S300, 320TR, S320TR, S380TRC;  <b>Castellini®:</b> SKEMA 5, SKEMA 6, SKEMA 8</p>	<p><b>Longitud:</b> 120cm  <b>Forma:</b> Angulada  <b>Color:</b> Gris (RAL 7038)  <b>Material:</b> Acero</p>	
		<b>Ref.: 39-11621C1</b>	<b>564<sup>80</sup>€</b>	<b>BAJO PEDIDO</b>
		<p>Jeringa Minilight 6F</p> <p><b>Conexión equipo Cefla® (desde 2006):</b>  <b>Anthos®:</b> A3, A5, A6, A7, A9, L6, L9, R7; <b>Stern Weber®:</b> S200, S220TR S250, S280TRC, S300, 320TR, S320TR, S380TRC;  <b>Castellini®:</b> SKEMA 5, SKEMA 6, SKEMA 8</p>	<p><b>Longitud:</b> 135cm  <b>Forma:</b> Angulada  <b>Color:</b> Gris (RAL 7038)  <b>Material:</b> Acero</p>	
		<b>Ref.: 39-11621C2</b>	<b>564<sup>80</sup>€</b>	<b>BAJO PEDIDO</b>

## Jeringas Luzzani® Minilight: Conector a equipo KaVo®



## Conector a equipo KaVo®





















## Descripción

		<p>Jeringa Minilight 3F</p> <p><b>Conexión equipo:</b> KaVo® 1057, 1058, 1060, 1062, 1063, 1065, 1066, 1078, 1080 (Series 1) <b>**Excepto**</b> 1058 Primus Life</p>	<p><b>Longitud:</b> 120cm  <b>Forma:</b> Recta  <b>Color:</b> Gris (RAL 7038)  <b>Material:</b> Acero</p>
		<b>Ref.: 39-12521K1</b>	<b>396<sup>80</sup>€</b>
		<p>Jeringa Minilight 3F</p> <p><b>Conexión equipo:</b> KaVo® 1057, 1058, 1060, 1062, 1063, 1065, 1066, 1078, 1080 (Series 1) <b>**Excepto**</b> 1058 Primus Life</p>	<p><b>Longitud:</b> 135cm  <b>Forma:</b> Recta  <b>Color:</b> Gris (RAL 7038)  <b>Material:</b> Acero</p>
		<b>Ref.: 39-12521K2</b>	<b>396<sup>80</sup>€</b>
		<p>Jeringa Minilight 3F</p> <p><b>Conexión equipo:</b> KaVo® E30, E50, E70, E80 y 1058 Primus Life (Serie 2)</p>	<p><b>Longitud:</b> 120cm  <b>Forma:</b> Recta  <b>Color:</b> Gris (RAL 7038)  <b>Material:</b> Acero</p>
		<b>Ref.: 39-12521K3</b>	<b>398<sup>00</sup>€</b>
		<p>Jeringa Minilight 3F</p> <p><b>Conexión equipo:</b> KaVo® E30, E50, E70, E80 y 1058 Primus Life (Serie 2)</p>	<p><b>Longitud:</b> 135cm  <b>Forma:</b> Recta  <b>Color:</b> Gris (RAL 7038)  <b>Material:</b> Acero</p>
		<b>Ref.: 39-12521K4</b>	<b>398<sup>00</sup>€</b>

TODOS LOS REPUESTOS JERINGAS LUZZANI® CONSULTE PRECIOS Y DESPIECES

## Conector a equipo KaVo®

## Características









		Jeringa Minilight 3F <b>Conexión equipo:</b> KaVo® 1057, 1058, 1060, 1062, 1063, 1065, 1066, 1078, 1080 (Series 1) <b>**Excepto**</b> 1058 Primus Life	<b>Longitud:</b> 120cm <b>Forma:</b> Angulada <b>Color:</b> Gris (RAL 7038) <b>Material:</b> Acero	<b>Ref.:</b> 39-12621K1	418 <sup>00</sup> €	
		Jeringa Minilight 3F <b>Conexión equipo:</b> KaVo® 1057, 1058, 1060, 1062, 1063, 1065, 1066, 1078, 1080 (Series 1) <b>**Excepto**</b> 1058 Primus Life	<b>Longitud:</b> 135cm <b>Forma:</b> Angulada <b>Color:</b> Gris (RAL 7038) <b>Material:</b> Acero	<b>Ref.:</b> 39-12621K2	418 <sup>00</sup> €	
		Jeringa Minilight 6F <b>Conexión equipo:</b> KaVo® 1057, 1058, 1060, 1062, 1063, 1065, 1066, 1078, 1080 (Series 1) <b>**Excepto**</b> 1058 Primus Life	<b>Longitud:</b> 120cm <b>Forma:</b> Recta <b>Color:</b> Gris (RAL 7038) <b>Material:</b> Acero	<b>Ref.:</b> 39-11521K1	564 <sup>80</sup> €	BAJO PEDIDO
		Jeringa Minilight 6F <b>Conexión equipo:</b> KaVo® 1057, 1058, 1060, 1062, 1063, 1065, 1066, 1078, 1080 (Series 1) <b>**Excepto**</b> 1058 Primus Life	<b>Longitud:</b> 135cm <b>Forma:</b> Recta <b>Color:</b> Gris (RAL 7038) <b>Material:</b> Acero	<b>Ref.:</b> 39-11521K2	564 <sup>80</sup> €	BAJO PEDIDO
		Jeringa Minilight 6F <b>Conexión equipo:</b> KaVo® 1057, 1058, 1060, 1062, 1063, 1065, 1066, 1078, 1080 (Series 1) <b>**Excepto**</b> 1058 Primus Life	<b>Longitud:</b> 120cm <b>Forma:</b> Angulada <b>Color:</b> Gris (RAL 7038) <b>Material:</b> Acero	<b>Ref.:</b> 39-11621K1	564 <sup>80</sup> €	BAJO PEDIDO
		Jeringa Minilight 6F <b>Conexión equipo:</b> KaVo® 1057, 1058, 1060, 1062, 1063, 1065, 1066, 1078, 1080 (Series 1) <b>**Excepto**</b> 1058 Primus Life	<b>Longitud:</b> 135cm <b>Forma:</b> Angulada <b>Color:</b> Gris (RAL 7038) <b>Material:</b> Acero	<b>Ref.:</b> 39-11621K2	564 <sup>80</sup> €	BAJO PEDIDO
		Jeringa Minilight 6F <b>Conexión equipo:</b> KaVo®, E30, E50, E70, E80, 1058 Primus Life (Serie 2)	<b>Longitud:</b> 120cm <b>Forma:</b> Recta <b>Color:</b> Gris (RAL 7038) <b>Material:</b> Acero	<b>Ref.:</b> 39-11521K3	554 <sup>80</sup> €	BAJO PEDIDO
		Jeringa Minilight 6F <b>Conexión equipo:</b> KaVo®, E30, E50, E70, E80, 1058 Primus Life (Serie 2)	<b>Longitud:</b> 135cm <b>Forma:</b> Recta <b>Color:</b> Gris (RAL 7038) <b>Material:</b> Acero	<b>Ref.:</b> 39-11521K4	554 <sup>80</sup> €	BAJO PEDIDO
		Jeringa Minilight 6F <b>Conexión equipo:</b> KaVo®, E30, E50, E70, E80, 1058 Primus Life (Serie 2)	<b>Longitud:</b> 120cm <b>Forma:</b> Angulada <b>Color:</b> Gris (RAL 7038) <b>Material:</b> Acero	<b>Ref.:</b> 39-11621K3	575 <sup>80</sup> €	BAJO PEDIDO
		Jeringa Minilight 6F <b>Conexión equipo:</b> KaVo®, E30, E50, E70, E80, 1058 Primus Life (Serie 2)	<b>Longitud:</b> 135cm <b>Forma:</b> Angulada <b>Color:</b> Gris (RAL 7038) <b>Material:</b> Acero	<b>Ref.:</b> 39-11621K4	575 <sup>80</sup> €	BAJO PEDIDO

TODOS LOS REPUESTOS JERINGAS LUZZANI® CONSULTE PRECIOS Y DESPIECES

SI NO ENCUENTRAS EL REPUESTO QUE BUCAS, ¡CONSÚLTANOS!  
Precios: impuestos, portes y mano de obra no incluidos.

Jeringas Luzzani® Minilight: **Conector a equipo Planmeca®**



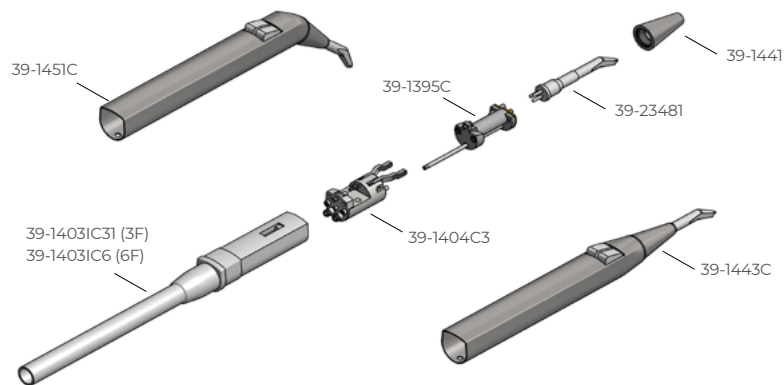

Conector a equipo Planmeca®		Características
  <p>Jeringa Minilight 3F Conexión equipo: Planmeca®</p> <p><b>Ref.: 39-12521P1</b></p> <p><b>418<sup>00</sup>€</b></p>	<p>Longitud: 100cm Forma: Recta Color: Gris claro (RAL 9002) Material: Acero Resistencia: 1.780 Ohm</p>	
  <p>Jeringa Minilight 3F Conexión equipo: Planmeca®</p> <p><b>Ref.: 39-12621P1</b></p> <p><b>428<sup>00</sup>€</b></p> <p><b>BAJO PEDIDO</b></p>	<p>Longitud: 100cm Forma: Angulada Color: Gris claro (RAL 9002) Material: Acero Resistencia: 1.780 Ohm</p>	
  <p>Jeringa Minilight 6F Conexión equipo: Planmeca®</p> <p><b>Ref.: 39-11521P1</b> (Ref. Planmeca®: 52600287-20)</p> <p><b>508<sup>00</sup>€</b></p> <p><b>BAJO PEDIDO</b></p>	<p>Longitud: 100cm Forma: Recta Color: Gris claro (RAL9002) Material: Acero Resistencia: 1.780 Ohm</p>	
  <p>Jeringa Minilight 6F Conexión equipo: Planmeca®</p> <p><b>Ref.: 39-11621P1</b></p> <p><b>508<sup>00</sup>€</b></p> <p><b>BAJO PEDIDO</b></p>	<p>Longitud: 100cm Forma: Angulada Color: Gris real (RAL 9002) Material: Acero Resistencia: 1.780 Ohm</p>	











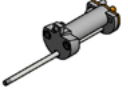

Consulta por las puntas desechables **Pro-Tip TURBO**

Repuestos Jeringas Minilight

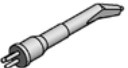

Descripción	Características
 <p>Kit completo reparación</p> <p><b>Ref.: 39-1000</b></p> <p><b>33<sup>80</sup>€</b></p>	
 <p>Kit completo 18 anillos tóricos</p> <p><b>Ref.: 39-1001</b></p> <p><b>20<sup>80</sup>€</b></p>	

TODOS LOS REPUESTOS JERINGAS LUZZANI® CONSULTE PRECIOS Y DESPIECES

	Descripción	Características
	Cabeza completa 3F  <b>Ref.: 39-1395C</b>	<b>73<sup>80</sup>€</b>
	Manguera completa jeringa 3F  <b>Ref.: 39-14031C31</b>	<b>71<sup>80</sup>€</b> Longitud: 170cm Color: Gris (RAL 7038) Material jeringa: Acero
	Manguera completa jeringa 6F  <b>Ref.: 39-14031C6</b>	<b>135<sup>80</sup>€</b> Longitud: 170cm Color: Gris (RAL 7038) Material jeringa: Acero
	Cuerpo jeringa 3F (NO 6F)  <b>Ref.: 39-1404C3</b>	<b>121<sup>80</sup>€</b>
	Cuerpo jeringa 6F  <b>Ref.: 39-1404</b>	<b>121<sup>80</sup>€</b>
	Cono Acero  <b>Ref.: 39-1441</b>	<b>14<sup>80</sup>€</b>
	Carcasa completa recta Acero  <b>Ref.: 39-1443C</b>	<b>124<sup>80</sup>€</b>
	Carcasa completa angulada Acero  <b>Ref.: 39-1451C</b>	<b>148<sup>00</sup>€</b>
	Punta gris  <b>Ref.: 39-23481</b>	<b>19<sup>80</sup>€</b>
	Adaptador jeringas Minilight Tecnopolimero a Acero  <b>Ref.: 39-1400</b>	<b>6<sup>80</sup>€</b>



TODOS LOS REPUESTOS JERINGAS LUZZANI® CONSULTE PRECIOS Y DESPIECES

SI NO ENCUENTRAS EL REPUESTO QUE BUSCAS, ¡CONSÚLTANOS!  
 Precios: impuestos, portes y mano de obra no incluidos.

Consulta por las  
puntas desechables  
**Pro-Tip TURBO**



**Jeringas Luzzani® Minimate: Conexión Abierta / Open End**

Conexión Abierta / Open End		Características
	Jeringa Minimate 3F Conexión equipo: Abierta  <b>Ref.: 39-251</b>	Longitud: 170cm Forma: Recta Color: Gris (RAL 7038) Material: Acero  <b>213<sup>80</sup>€</b>
	Jeringa Minimate 3F Conexión equipo: Abierta  <b>Ref.: 39-261</b>	Longitud: 170cm Forma: Angulada Color: Gris (RAL 7038) Material: Acero  <b>223<sup>80</sup>€</b>

**Jeringas Luzzani® Minimate: Conector a equipo Cefla® (desde 2006)**

















Conector a equipo Cefla® desde 2006		Descripción
 	Jeringa Minimate 3F <b>Conexión equipo Cefla® (desde 2006):</b> Anthos®: A3, A5, A6, A7, A9, L6, L9, R7; Stern Weber®: S200, S220TR S250, S280TRC, S300, 320TR, S320TR, S380TRC; Castellini®: SKEMA 5, SKEMA 6, SKEMA 8  <b>Ref.: 39-251C1</b>	Longitud: 120cm Forma: Recta Color: Gris (RAL 7038) Material: Acero  <b>323<sup>80</sup>€</b>
 	Jeringa Minimate 3F <b>Conexión equipo Cefla® (desde 2006):</b> Anthos®: A3, A5, A6, A7, A9, L6, L9, R7; Stern Weber®: S200, S220TR S250, S280TRC, S300, 320TR, S320TR, S380TRC; Castellini®: SKEMA 5, SKEMA 6, SKEMA 8  <b>Ref.: 39-251C2</b>	Longitud: 135cm Forma: Recta Color: Gris (RAL 7038) Material: Acero  <b>323<sup>80</sup>€</b>
 	Jeringa Minimate 3F <b>Conexión equipo Cefla® (desde 2006):</b> Anthos®: A3, A5, A6, A7, A9, L6, L9, R7; Stern Weber®: S200, S220TR S250, S280TRC, S300, 320TR, S320TR, S380TRC; Castellini®: SKEMA 5, SKEMA 6, SKEMA 8  <b>Ref.: 39-261C1</b>	Longitud: 120cm Forma: Angulada Color: Gris (RAL 7038) Material: Acero  <b>344<sup>80</sup>€</b>
 	Jeringa Minimate 3F <b>Conexión equipo Cefla® (desde 2006):</b> Anthos®: A3, A5, A6, A7, A9, L6, L9, R7; Stern Weber®: S200, S220TR S250, S280TRC, S300, 320TR, S320TR, S380TRC; Castellini®: SKEMA 5, SKEMA 6, SKEMA 8  <b>Ref.: 39-261C2</b>	Longitud: 135cm Forma: Angulada Color: Gris (RAL 7038) Material: Acero  <b>344<sup>80</sup>€</b>

TODOS LOS REPUESTOS JERINGAS LUZZANI® CONSULTE PRECIOS Y DESPIECES

## Jeringas Luzzani® Minimate: Conector a equipo KaVo®

### Conexión a equipo KaVo®





### Características

		<p>Jeringa Minimate 3F</p> <p><b>Conexión equipo:</b> KaVo® 1057, 1058, 1060, 1062, 1063, 1065, 1066, 1078, 1080 (Series 1) <b>**Excepto**</b> 1058 Primus Life</p>	<p><b>Longitud:</b> 120cm</p> <p><b>Forma:</b> Recta</p> <p><b>Color:</b> Gris (RAL 7038)</p> <p><b>Material:</b> Acero</p>
<b>Ref.:</b>	<b>39-251K1</b>	<b>323´80€</b>	
		<p>Jeringa Minimate 3F</p> <p><b>Conexión equipo:</b> KaVo® 1057, 1058, 1060, 1062, 1063, 1065, 1066, 1078, 1080 (Series 1) <b>**Excepto**</b> 1058 Primus Life</p>	<p><b>Longitud:</b> 135cm</p> <p><b>Forma:</b> Recta</p> <p><b>Color:</b> Gris (RAL 7038)</p> <p><b>Material:</b> Acero</p>
<b>Ref.:</b>	<b>39-251K2</b>	<b>323´80€</b>	
		<p>Jeringa Minimate 3F</p> <p><b>Conexión equipo:</b> KaVo®, E30, E50, E70, E80, 1058 Primus Life (Serie 2)</p>	<p><b>Longitud:</b> 120cm</p> <p><b>Forma:</b> Recta</p> <p><b>Color:</b> Gris (RAL 7038)</p> <p><b>Material:</b> Acero</p>
<b>Ref.:</b>	<b>39-251K3</b>	<b>333´80€</b>	
		<p>Jeringa Minimate 3F</p> <p><b>Conexión equipo:</b> KaVo®, E30, E50, E70, E80, 1058 Primus Life (Serie 2)</p>	<p><b>Longitud:</b> 135cm</p> <p><b>Forma:</b> Recta</p> <p><b>Color:</b> Gris (RAL 7038)</p> <p><b>Material:</b> Acero</p>
<b>Ref.:</b>	<b>39-251K4</b>	<b>333´80€</b>	<b>BAJO PEDIDO</b>
		<p>Jeringa Minimate 3F</p> <p><b>Conexión equipo:</b> KaVo® 1057, 1058, 1060, 1062, 1063, 1065, 1066, 1078, 1080 (Series 1) <b>**Excepto**</b> 1058 Primus Life</p>	<p><b>Longitud:</b> 120cm</p> <p><b>Forma:</b> Angulada</p> <p><b>Color:</b> Gris (RAL 7038)</p> <p><b>Material:</b> Acero</p>
<b>Ref.:</b>	<b>39-261K1</b>	<b>344´80€</b>	
		<p>Jeringa Minimate 3F</p> <p><b>Conexión equipo:</b> KaVo® 1057, 1058, 1060, 1062, 1063, 1065, 1066, 1078, 1080 (Series 1) <b>**Excepto**</b> 1058 Primus Life</p>	<p><b>Longitud:</b> 135cm</p> <p><b>Forma:</b> Angulada</p> <p><b>Color:</b> Gris (RAL 7038)</p> <p><b>Material:</b> Acero</p>
<b>Ref.:</b>	<b>39-261K2</b>	<b>344´80€</b>	
		<p>Jeringa Minimate 3F</p> <p><b>Conexión equipo:</b> KaVo®, E30, E50, E70, E80, 1058 Primus Life (Serie 2)</p>	<p><b>Longitud:</b> 120cm</p> <p><b>Forma:</b> Angulada</p> <p><b>Color:</b> Gris (RAL 7038)</p> <p><b>Material:</b> Acero</p>
<b>Ref.:</b>	<b>39-261K3</b>	<b>354´80€</b>	

## Jeringas Luzzani® Minimate: Conector a equipo Planmeca®

### Conexión a equipo Planmeca®

### Descripción

		<p>Jeringa Miniassistant 3F</p> <p><b>Conexión equipo:</b> Planmeca®</p>	<p><b>Longitud:</b> 100cm</p> <p><b>Forma:</b> Recta</p> <p><b>Color:</b> Gris real (RAL 9002)</p> <p><b>Material:</b> Acero</p> <p><b>Resistencia:</b> 1.780 Ohm</p>
<b>Ref.:</b>	<b>39-251P1</b>	<b>358´80€</b>	
		<p>Jeringa Miniassistant 3F</p> <p><b>Conexión equipo:</b> Planmeca®</p>	<p><b>Longitud:</b> 100cm</p> <p><b>Forma:</b> Angulada</p> <p><b>Color:</b> Gris real (RAL 9002)</p> <p><b>Material:</b> Acero</p> <p><b>Resistencia:</b> 1.780 Ohm</p>
<b>Ref.:</b>	<b>39-261P1</b>	<b>368´80€</b>	<b>BAJO PEDIDO</b>

TODOS LOS REPUESTOS JERINGAS LUZZANI® CONSULTE PRECIOS Y DESPIECES





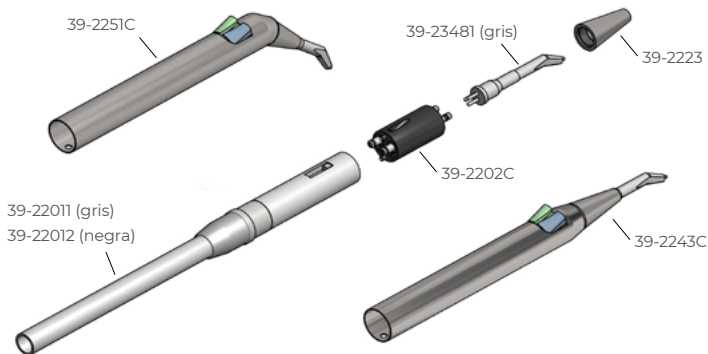

SI NO ENCUENTRAS EL REPUESTO QUE BUCAS, ¡CONSÚLTANOS!  
Precios: impuestos, portes y mano de obra no incluidos.

Consulta por las  
puntas desechables  
**Pro-Tip<sup>TURBO</sup>**



Repuestos Jeringas Minimate

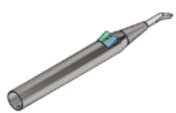

	Descripción	Características
	Kit completo reparación  <b>Ref.: 39-2000</b>	34'80€
	Manguera completa para jeringa 3F  <b>Ref.: 39-22011</b>	Longitud: 170cm Color: Gris (RAL 7038) Material jeringa: Acero  74'80€
	Cuerpo jeringa 3F  <b>Ref.: 39-2202C</b>	102'80€
	Cono Acero  Origen: Italia      Fabricante: Luzzani® Dental S.R.L.      Garantía: 12 meses  <b>Ref.: 39-2223</b>	14'80€
	Carcasa completa recta Acero  <b>Ref.: 39-2243C</b>	Forma: Recta Material: Acero  110'80€
	Carcasa completa angulada Acero  <b>Ref.: 39-2251C</b>	Forma: Angulada Material: Acero  122'80€
	Punta gris  <b>Ref.: 39-23481</b>	19'80€

TODOS LOS REPUESTOS JERINGAS LUZZANI® CONSULTE PRECIOS Y DESPIECES



Consulta por las  
puntas desechables  
**Pro-Tip<sup>TURBO</sup>**



Jeringas Faro<sup>®</sup> SYR3



Conexión Abierta / Open End

Características



Jeringa Faro SYR3  
Conexión equipo: Abierta

**¡ÚLTIMAS UNIDADES!**

Ref.: **80-500100** (Ref. Faro<sup>®</sup>: 094000100)

**225<sup>80</sup>€**

Forma: Recta  
Color: Gris (RAL 7038)  
Material: Acero

**HASTA AGOTAR**

Consulta por las  
puntas desechables  
**Pro-Tip<sup>TURBO</sup>**

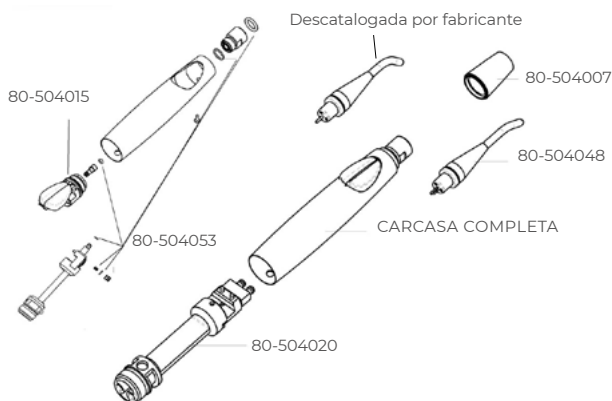

Repuestos Jeringas Faro<sup>®</sup> SYR3



Descripción

Características



Cono acero

Ref.: **80-504007** (Ref. Faro<sup>®</sup>: SP094007)

**27<sup>30</sup>€**



Botonera aire/agua jeringa (luds.)

Ref.: **80-504015** (Ref. Faro<sup>®</sup>: SP094015 /3)

**24<sup>80</sup>€**

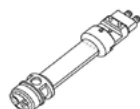

Cuerpo jeringa

Ref.: **80-504020** (Ref. Faro<sup>®</sup>: SP094020)

**152<sup>80</sup>€**

**TODOS LOS REPUESTOS FARO<sup>®</sup> CONSULTE PRECIOS Y DESPIECES**

SI NO ENCUENTRAS EL REPUESTO QUE BUSCAS, ¡CONSÚLTANOS!  
Precios: impuestos, portes y mano de obra no incluidos.

	<p>Punta recta gris jeringa</p> <p><b>Ref.: 80-504048</b> (Ref. Faro®: SP094048)</p> <p><b>42<sup>80</sup>€</b></p>	
 <p>Imagen no disponible</p> <p>Ver despiece</p>	<p>Kit completo reparación jeringa</p> <p><b>Ref.: 80-504053</b> (Ref. Faro®: SP094053)</p> <p><b>64<sup>80</sup>€</b></p>	



Repuestos Jeringas Faro® SM3



	Descripción	Características
	<p>Medios aire/agua</p> <p><b>Ref.: 80-501291</b> (Ref. Faro®: SP091291)</p> <p><b>29<sup>80</sup>€</b></p>	

Jeringas de acero ECO



	Descripción	Características
	<p>Jeringa de acero, 3F angulada (No manguera)*</p> <p><b>Ref.: 44-280</b></p> <p><b>32<sup>80</sup>€</b></p>	<p>*Ver manguera 40-61A2000</p>
	<p>Jeringa de acero, 3F recta (No manguera)*</p> <p><b>Ref.: 44-281</b></p> <p><b>32<sup>80</sup>€</b></p>	<p>*Ver manguera 40-61A2000</p>
	<p>Cánulas de repuesto, esterilizables</p> <p><b>Ref.: 44-285</b></p> <p><b>2<sup>80</sup>€</b></p>	

TODOS LOS REPUESTOS FARO® CONSULTE PRECIOS Y DESPIECES

## Puntas compatibles jeringas

	Descripción	Características
	Punta para jeringa <b>Cefla® 3F</b> . Compatible  <b>Ref.: 44-287</b> (Ref. Cefla®: 95520612)	Esterilizable 135°C  <b>58'00€</b>
	Punta para jeringa <b>KaVo® 3F</b> . Compatible  <b>Ref.: 44-288</b> (Ref. KaVo®: 0.773.0011)	Esterilizable 135°C  <b>108'00€</b>
	Punta para jeringa <b>Sirona® 3F</b> . Compatible  <b>Ref.: 44-289</b> (Ref. Sirona®: 5992206)	Esterilizable 135°C  <b>108'00€</b>

## ▶ MANGUERAS EQUIPO

- Mangueras turbinas con y sin conector a equipo
- Mangueras ultrasonidos con y sin conector a equipo
- Mangueras micromotores con y sin conector a equipo
- Accesorios mangueras
- Mangueras jeringas con y sin conector a equipo
- Mangueras pedales

RUMAR



- **Origen:** Italia
- **Fabricante:** Tekne Dental (TKD®)
- **Silicona de máxima calidad** que garantiza su durabilidad y el mantenimiento de los colores durante más tiempo.
- **Cables y tubos internos de la más alta calidad para una mayor durabilidad**
- **Valvulería de acero** para las mangueras con regulación de spray: mayor precisión y durabilidad.

**12 MESES DE GARANTÍA**

**¡Los fabricantes de sillones, y nosotros, confiamos en ellos!**

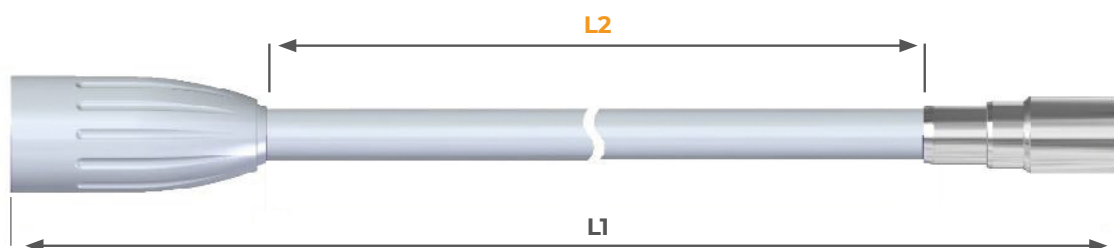

**L2:** Longitud indicada en cada referencia en este catálogo.

### Información sobre tonos de Gris:











Gris CLARO= **RAL 9002** (Tipo: KaVo®, Planmeca® y similares)











Gris = **RAL 7035** (Tipo: ADEC y similares)

Gris OSCURO = **RAL 7038** (Tipo: Fedesa y similares) o RAL 7035+ (EEUU)



**Conexión Abierta / Open End****Características**

	<p><b>Conexión instrumento:</b> Borden 3 - 3 orificios, sin luz <b>Conexión equipo:</b> Abierta</p> <p><b>Origen:</b> Italia      <b>Fabricante:</b> Tekne Dental (TKD®)      <b>Garantía:</b> 12 meses</p> <p><b>Ref.:</b> <b>40-31A2001</b></p>	<p><b>Longitud:</b> 160cm - Rizada <b>Color:</b> Gris oscuro (Ral 7038)</p> <p><b>39' 80€</b></p>
	<p><b>Conexión instrumento:</b> Borden 3 - 3 orificios, sin luz <b>Conexión equipo:</b> Abierta</p> <p><b>Origen:</b> Italia      <b>Fabricante:</b> Tekne Dental (TKD®)      <b>Garantía:</b> 12 meses</p> <p><b>Ref.:</b> <b>40-31A2000</b></p>	<p><b>Longitud:</b> 160cm <b>Color:</b> Gris oscuro (RAL 7038)</p> <p><b>63' 80€</b></p>
	<p><b>Conexión instrumento:</b> Midwest 4 con luz - 6 orificios <b>Conexión equipo:</b> Abierta</p> <p><b>Origen:</b> Italia      <b>Fabricante:</b> Tekne Dental (TKD®)      <b>Garantía:</b> 12 meses</p> <p><b>Ref.:</b> <b>40-11B1000</b></p>	<p><b>Longitud:</b> 200cm <b>Color:</b> Gris claro (RAL 9002)</p> <p><b>75' 80€</b></p>
	<p><b>Conexión instrumento:</b> Midwest 4 con luz - 6 orificios, <b>Conexión equipo:</b> Abierta</p> <p><b>Origen:</b> Italia      <b>Fabricante:</b> Tekne Dental (TKD®)      <b>Garantía:</b> 12 meses</p> <p><b>Ref.:</b> <b>40-11A1000</b></p>	<p><b>Longitud:</b> 160cm <b>Color:</b> Gris claro (RAL 9002)</p> <p><b>64' 80€</b></p>
	<p><b>Conexión instrumento:</b> Midwest 4 con luz - 6 orificios <b>Conexión equipo:</b> Abierta</p> <p><b>Origen:</b> Italia      <b>Fabricante:</b> Tekne Dental (TKD®)      <b>Garantía:</b> 12 meses</p> <p><b>Ref.:</b> <b>40-11A1001</b></p>	<p><b>Longitud:</b> 160cm <b>Color:</b> Gris claro (RAL 9002) <b>Regulación de spray</b></p> <p><b>139' 80€</b></p>
	<p><b>Conexión instrumento:</b> Midwest 4 con luz - 6 orificios <b>Conexión equipo:</b> Abierta</p> <p><b>Origen:</b> Italia      <b>Fabricante:</b> Tekne Dental (TKD®)      <b>Garantía:</b> 12 meses</p> <p><b>Ref.:</b> <b>40-11B2000</b></p>	<p><b>Longitud:</b> 200cm <b>Color:</b> Gris oscuro (RAL 7038)</p> <p><b>75' 80€</b></p>
	<p><b>Conexión instrumento:</b> Midwest 4 con luz - 6 orificios <b>Conexión equipo:</b> Abierta</p> <p><b>Origen:</b> Italia      <b>Fabricante:</b> Tekne Dental (TKD®)      <b>Garantía:</b> 12 meses</p> <p><b>Ref.:</b> <b>40-11A2000</b></p>	<p><b>Longitud:</b> 160cm <b>Color:</b> Gris oscuro (RAL 7038)</p> <p><b>64' 80€</b></p>
	<p><b>Conexión instrumento:</b> Midwest 4 con luz - 6 orificios <b>Conexión equipo:</b> Abierta</p> <p><b>Origen:</b> Italia      <b>Fabricante:</b> Tekne Dental (TKD®)      <b>Garantía:</b> 12 meses</p> <p><b>Ref.:</b> <b>40-11A2001</b></p>	<p><b>Longitud:</b> 160cm <b>Color:</b> Gris oscuro (RAL 7038) <b>Regulación de spray</b></p> <p><b>139' 80€</b></p>
	<p><b>Conexión instrumento:</b> Midwest 4 con luz - 6 orificios <b>Conexión equipo:</b> Abierta</p> <p><b>Origen:</b> Italia      <b>Fabricante:</b> Tekne Dental (TKD®)      <b>Garantía:</b> 12 meses</p> <p><b>Ref.:</b> <b>40-11A2002</b></p>	<p><b>Longitud:</b> 160cm <b>Color:</b> Gris oscuro (RAL 7038) <b>Diámetro:</b> 10,33mm <b>(Especial equipos Vitali, OMS y comp.)</b></p> <p><b>64' 80€</b></p>
	<p><b>Conexión instrumento:</b> Midwest 4 con luz - 6 orificios <b>Conexión equipo:</b> Abierta</p> <p><b>Origen:</b> Italia      <b>Fabricante:</b> Tekne Dental (TKD®)      <b>Garantía:</b> 12 meses</p> <p><b>Ref.:</b> <b>40-11B3000</b></p>	<p><b>Longitud:</b> 200cm <b>Color:</b> Negro</p> <p><b>75' 80€</b></p>

	Conexión Abierta / Open End	Descripción
	<p><b>Conexión instrumento:</b> Midwest 4 con luz – 6 orificios <b>Conexión equipo:</b> Abierta</p> <p><b>Origen:</b> Italia      <b>Fabricante:</b> Tekne Dental (TKD®)      <b>Garantía:</b> 12 meses</p> <p><b>Ref.:</b> <b>40-11B4000</b></p>	<p><b>Longitud:</b> 200cm <b>Color:</b> Blanco</p> <p><b>75'80€</b></p>
	<p><b>Conexión instrumento:</b> Midwest 4 sin luz – 4 orificios <b>Conexión equipo:</b> Abierta</p> <p><b>Origen:</b> Italia      <b>Fabricante:</b> Tekne Dental (TKD®)      <b>Garantía:</b> 12 meses</p> <p><b>Ref.:</b> <b>40-21A2001</b></p>	<p><b>Longitud:</b> 160cm - <b>Rizada</b> <b>Color:</b> Gris oscuro (RAL 7038)</p> <p><b>39'80€</b></p>
	<p><b>Conexión instrumento:</b> Midwest 4 sin luz – 4 orificios <b>Conexión equipo:</b> Abierta</p> <p><b>Origen:</b> Italia      <b>Fabricante:</b> Tekne Dental (TKD®)      <b>Garantía:</b> 12 meses</p> <p><b>Ref.:</b> <b>40-21A1000</b></p>	<p><b>Longitud:</b> 160cm <b>Color:</b> Gris claro (RAL 9002)</p> <p><b>54'80€</b></p>
	<p><b>Conexión instrumento:</b> Midwest 4 sin luz – 4 orificios <b>Conexión equipo:</b> Abierta</p> <p><b>Origen:</b> Italia      <b>Fabricante:</b> Tekne Dental (TKD®)      <b>Garantía:</b> 12 meses</p> <p><b>Ref.:</b> <b>40-21A2000</b></p>	<p><b>Longitud:</b> 160cm <b>Color:</b> Gris oscuro (RAL 7038)</p> <p><b>54'80€</b></p>
	<p><b>Conexión instrumento:</b> Midwest 4 sin luz – 4 orificios <b>Conexión equipo:</b> Abierta</p> <p><b>Origen:</b> Italia      <b>Fabricante:</b> Tekne Dental (TKD®)      <b>Garantía:</b> 12 meses</p> <p><b>Ref.:</b> <b>40-21A2002</b></p>	<p><b>Longitud:</b> 160cm <b>Color:</b> Gris oscuro (RAL 7038) <b>Regulación de spray</b></p> <p><b>119'80€</b></p>
	<p><b>Conexión instrumento:</b> Midwest 4 sin luz – 4 orificios <b>Conexión equipo:</b> Abierta</p> <p><b>Origen:</b> Italia      <b>Fabricante:</b> Tekne Dental (TKD®)      <b>Garantía:</b> 12 meses</p> <p><b>Ref.:</b> <b>40-21B1000</b></p>	<p><b>Longitud:</b> 200cm <b>Color:</b> Gris claro (RAL 9002)</p> <p><b>69'80€</b></p>
	<p><b>Conexión instrumento:</b> Midwest 4 sin luz – 4 orificios <b>Conexión equipo:</b> Abierta</p> <p><b>Origen:</b> Italia      <b>Fabricante:</b> Tekne Dental (TKD®)      <b>Garantía:</b> 12 meses</p> <p><b>Ref.:</b> <b>40-21B2000</b></p>	<p><b>Longitud:</b> 200cm <b>Color:</b> Gris oscuro (RAL 7038)</p> <p><b>69'80€</b></p>
	<p><b>Conexión instrumento:</b> Midwest 4 sin luz – 4 orificios <b>Conexión equipo:</b> Abierta</p> <p><b>Origen:</b> Italia      <b>Fabricante:</b> Tekne Dental (TKD®)      <b>Garantía:</b> 12 meses</p> <p><b>Ref.:</b> <b>40-21B3000</b></p>	<p><b>Longitud:</b> 200cm <b>Color:</b> Negro</p> <p><b>69'80€</b></p>
	<p><b>Conexión instrumento:</b> Midwest 4 sin luz – 4 orificios <b>Conexión equipo:</b> Abierta</p> <p><b>Origen:</b> Italia      <b>Fabricante:</b> Tekne Dental (TKD®)      <b>Garantía:</b> 12 meses</p> <p><b>Ref.:</b> <b>40-21B4000</b></p>	<p><b>Longitud:</b> 200cm <b>Color:</b> Blanco</p> <p><b>78'80€</b></p>
	<p><b>Conexión instrumento:</b> Manguera 4 vías <b>Conexión equipo:</b> Abierta</p> <p><b>Origen:</b> EEUU      <b>Garantía:</b> 6 meses</p> <p><b>Ref.:</b> <b>40-007</b></p>	<p><b>Longitud:</b> 160cm - <b>Rizada</b> <b>Color:</b> Gris oscuro (RAL 7035 +)</p> <p><b>25'80€</b></p> <p><b>HASTA AGOTAR</b></p>

## Mangueras para Turbina: Conector a equipo Cefla® (desde 2006)

RUMAR



## Conector a equipo Cefla® (desde 2006), Castellini, Anthos, Stern Weber

## Características

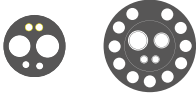
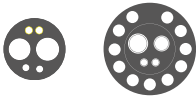
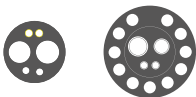
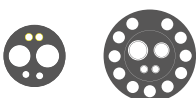
	<p><b>Conexión instrumento:</b> Midwest 4 con luz - 6 orificios</p> <p><b>Conexión equipo Cefla® (desde 2006):</b>  <b>Anthos®:</b> A3, A5, A6, A7, A9, L6, L9, R7; <b>Stern Weber®:</b> S200, S220TR S250, S280TRC, S300, 320TR, S320TR, S380TRC;  <b>Castellini®:</b> SKEMA 5, SKEMA 6, SKEMA 8</p> <p><b>Origen:</b> Italia      <b>Fabricante:</b> Tekne Dental (TKD®)      <b>Garantía:</b> 12 meses</p> <p><b>Ref.:</b> <b>40-12E2021</b>      <b>296<sup>80</sup>€</b></p>	<p><b>Longitud:</b> 135cm  <b>Color:</b> Gris oscuro (RAL 7038)  <b>Regulación de spray</b></p>
	<p><b>Conexión instrumento:</b> Midwest 4 con luz - 6 orificios</p> <p><b>Conexión equipo Cefla® (desde 2006):</b>  <b>Anthos®:</b> A3, A5, A6, A7, A9, L6, L9, R7; <b>Stern Weber®:</b> S200, S220TR S250, S280TRC, S300, 320TR, S320TR, S380TRC;  <b>Castellini®:</b> SKEMA 5, SKEMA 6, SKEMA 8</p> <p><b>Origen:</b> Italia      <b>Fabricante:</b> Tekne Dental (TKD®)      <b>Garantía:</b> 12 meses</p> <p><b>Ref.:</b> <b>40-12G2021</b>      <b>299<sup>80</sup>€</b></p>	<p><b>Longitud:</b> 120cm  <b>Color:</b> Gris oscuro (RAL 7038)  <b>Regulación de spray</b></p>
	<p><b>Conexión instrumento:</b> Midwest 4 con luz - 6 orificios</p> <p><b>Conexión equipo Cefla® (desde 2006):</b>  <b>Anthos®:</b> A3, A5, A6, A7, A9, L6, L9, R7; <b>Stern Weber®:</b> S200, S220TR S250, S280TRC, S300, 320TR, S320TR, S380TRC;  <b>Castellini®:</b> SKEMA 5, SKEMA 6, SKEMA 8</p> <p><b>Origen:</b> Italia      <b>Fabricante:</b> Tekne Dental (TKD®)      <b>Garantía:</b> 12 meses</p> <p><b>Ref.:</b> <b>40-12E2022</b>      <b>143<sup>80</sup>€</b></p>	<p><b>Longitud:</b> 135cm  <b>Color:</b> Gris oscuro (RAL 7038)</p>
	<p><b>Conexión instrumento:</b> Midwest 4 con luz - 6 orificios</p> <p><b>Conexión equipo Cefla® (desde 2006):</b>  <b>Anthos®:</b> A3, A5, A6, A7, A9, L6, L9, R7; <b>Stern Weber®:</b> S200, S220TR S250, S280TRC, S300, 320TR, S320TR, S380TRC;  <b>Castellini®:</b> SKEMA 5, SKEMA 6, SKEMA 8</p> <p><b>Origen:</b> Italia      <b>Fabricante:</b> Tekne Dental (TKD®)      <b>Garantía:</b> 12 meses</p> <p><b>Ref.:</b> <b>40-12G2022</b>      <b>138<sup>80</sup>€</b></p>	<p><b>Longitud:</b> 120cm  <b>Color:</b> Gris oscuro (RAL 7038)</p>



## Mangueras para Turbina: Conector a equipo KaVo®

RUMAR

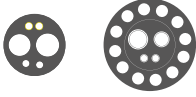
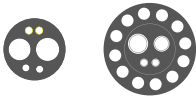
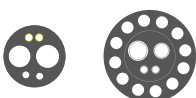

## Conector a equipo KaVo®

## Características

	<p><b>Conexión instrumento:</b> Midwest 4 con luz - 6 orificios</p> <p><b>Conexión equipo:</b> KaVo® 1057, 1058*, 1060, 1062, 1063, 1065, 1066, 1080, (Serie 1), (*Excepto 1058TM Primus Life).</p> <p><b>Origen:</b> Italia      <b>Fabricante:</b> Tekne Dental (TKD®)      <b>Garantía:</b> 12 meses</p> <p><b>Ref.:</b> <b>40-12G6010</b>      <b>156<sup>80</sup>€</b></p>	<p><b>Longitud:</b> 120cm  <b>Color:</b> Gris medio (RAL 7035)</p>
	<p><b>Conexión instrumento:</b> Midwest 4 con luz - 6 orificios</p> <p><b>Conexión equipo:</b> KaVo® 1057, 1058*, 1060, 1062, 1063, 1065, 1066, 1080, (Serie 1), (*Excepto 1058TM Primus Life).</p> <p><b>Origen:</b> Italia      <b>Fabricante:</b> Tekne Dental (TKD®)      <b>Garantía:</b> 12 meses</p> <p><b>Ref.:</b> <b>40-12E6010</b>      <b>159<sup>80</sup>€</b></p>	<p><b>Longitud:</b> 135cm  <b>Color:</b> Gris medio (RAL 7035)</p>
	<p><b>Conexión instrumento:</b> Midwest 4 con luz - 6 orificios</p> <p><b>Conexión equipo:</b> KaVo® 1057, 1058*, 1060, 1062, 1063, 1065, 1066, 1080, (Serie 1), (*Excepto 1058TM Primus Life).</p> <p><b>Origen:</b> Italia      <b>Fabricante:</b> Tekne Dental (TKD®)      <b>Garantía:</b> 12 meses</p> <p><b>Ref.:</b> <b>40-12G6011</b>      <b>296<sup>80</sup>€</b></p>	<p><b>Longitud:</b> 120cm  <b>Color:</b> Gris medio (RAL 7035)  <b>Regulación de spray</b></p> <p style="text-align: right;"><b>BAJO PEDIDO</b></p>
	<p><b>Conexión instrumento:</b> Midwest 4 con luz - 6 orificios</p> <p><b>Conexión equipo:</b> KaVo® 1057, 1058*, 1060, 1062, 1063, 1065, 1066, 1080, (Serie 1), (*Excepto 1058TM Primus Life).</p> <p><b>Origen:</b> Italia      <b>Fabricante:</b> Tekne Dental (TKD®)      <b>Garantía:</b> 12 meses</p> <p><b>Ref.:</b> <b>40-12E6011</b>      <b>299<sup>80</sup>€</b></p>	<p><b>Longitud:</b> 135cm  <b>Color:</b> Gris medio (RAL 7035)  <b>Regulación de spray</b></p> <p style="text-align: right;"><b>BAJO PEDIDO</b></p>
	<p><b>Conexión instrumento:</b> Midwest 4 con luz - 6 orificios</p> <p><b>Conexión equipo:</b> KaVo® E30, E50TM, E70TM, E80TM y 1058 Primus Life (Serie 2).</p> <p><b>Origen:</b> Italia      <b>Fabricante:</b> Tekne Dental (TKD®)      <b>Garantía:</b> 12 meses</p> <p><b>Ref.:</b> <b>40-12G6012</b>      <b>168<sup>00</sup>€</b></p>	<p><b>Longitud:</b> 120cm  <b>Color:</b> Gris medio (RAL 7035)</p>



## Conector a equipo KaVo®

## Características

	<p><b>Conexión instrumento:</b> Midwest 4 con luz - 6 orificios  <b>Conexión equipo:</b> KaVo® E30, E50TM, E70TN, E80TM y 1058 Primus Life (Serie 2).</p> <p><b>Origen:</b> Italia      <b>Fabricante:</b> Tekne Dental (TKD®)      <b>Garantía:</b> 12 meses</p> <p><b>Ref.:</b> <b>40-12E6012</b></p>	<p><b>Longitud:</b> 135cm  <b>Color:</b> Gris medio (RAL 7035)</p>
	<p><b>Conexión instrumento:</b> Midwest 4 con luz - 6 orificios  <b>Conexión equipo:</b> KaVo® E30, E50TM, E70TN, E80TM y 1058 Primus Life (Serie 2).</p> <p><b>Origen:</b> Italia      <b>Fabricante:</b> Tekne Dental (TKD®)      <b>Garantía:</b> 12 meses</p> <p><b>Ref.:</b> <b>40-12G6013</b></p>	<p><b>Longitud:</b> 120cm  <b>Color:</b> Gris medio (RAL 7035)  <b>Regulación de spray</b></p> <p style="text-align: right;"><b>BAJO PEDIDO</b></p>
	<p><b>Conexión instrumento:</b> Midwest 4 con luz - 6 orificios  <b>Conexión equipo:</b> KaVo® E30, E50TM, E70TN, E80TM y 1058 Primus Life (Serie 2).</p> <p><b>Origen:</b> Italia      <b>Fabricante:</b> Tekne Dental (TKD®)      <b>Garantía:</b> 12 meses</p> <p><b>Ref.:</b> <b>40-12E6013</b></p>	<p><b>Longitud:</b> 135cm  <b>Color:</b> Gris medio (RAL 7035)  <b>Regulación de spray</b></p> <p style="text-align: right;"><b>BAJO PEDIDO</b></p>

## Mangueras para Turbina: Conector a equipo Sirona®

RUMAR



## Conector a equipo Sirona®

## Características

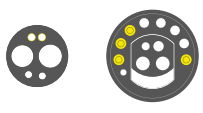
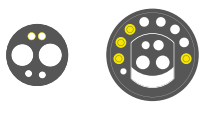
	<p><b>Conexión instrumento:</b> Midwest 4 con luz - 6 orificios  <b>Conexión equipo:</b> Sirona® A1, A2, A4, A5, AC, C1, C1+, C2, C2+, C4, C4+, C5+, C8, C8+, C9+, E1, E2, E4, E5, EC, M1, M1+, Profeel, Spirit, S1, S2, INTEGO, INTEGO PRO, TENEO, SINIUS.</p> <p><b>Origen:</b> Italia      <b>Fabricante:</b> Tekne Dental (TKD®)      <b>Garantía:</b> 12 meses</p> <p><b>Ref.:</b> <b>40-12L1000</b> (Ref. Sirona®: 6216274)</p>	<p><b>Longitud:</b> 137cm  <b>Color:</b> Gris claro (RAL 9002)</p>
	<p><b>Conexión instrumento:</b> Midwest 4 con luz - 6 orificios  <b>Conexión equipo:</b> Sirona® C3, C3+, C6, E3.</p> <p><b>Origen:</b> Italia      <b>Fabricante:</b> Tekne Dental (TKD®)      <b>Garantía:</b> 12 meses</p> <p><b>Ref.:</b> <b>40-12M1000</b> (Ref. Sirona®: 8924631)</p>	<p><b>Longitud:</b> 103cm  <b>Color:</b> Gris claro (RAL 9002)</p>

## Mangueras para Turbina: Conector a equipo Planmeca®

RUMAR







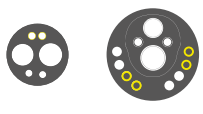
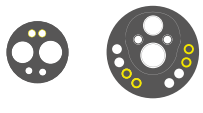





## Conector a equipo Planmeca®

## Características















	<p><b>Conexión instrumento:</b> Midwest 4 con luz - 6 orificios  <b>Conexión equipo:</b> Planmeca®</p> <p><b>Origen:</b> Italia      <b>Fabricante:</b> Tekne Dental (TKD®)      <b>Garantía:</b> 12 meses</p> <p><b>Ref.:</b> <b>40-12M1001</b> (Ref. Planmeca®: J2600265-11)</p>	<p><b>Longitud:</b> 103cm  <b>Color:</b> Gris claro (RAL 9002)  <b>Resistencia:</b> 820 Ohm</p>
	<p><b>Conexión instrumento:</b> Midwest 4 con luz - 6 orificios  <b>Conexión equipo:</b> Planmeca®</p> <p><b>Origen:</b> Italia      <b>Fabricante:</b> Tekne Dental (TKD®)      <b>Garantía:</b> 12 meses</p> <p><b>Ref.:</b> <b>40-12K1001</b> (Ref. Planmeca®: J2600203-8)</p>	<p><b>Longitud:</b> 90cm  <b>Color:</b> Gris claro (RAL 9002)  <b>Resistencia:</b> 560 Ohm</p>
	<p><b>Conexión instrumento:</b> Midwest 4 con luz - 6 orificios  <b>Conexión equipo:</b> Planmeca®</p> <p><b>Origen:</b> Italia      <b>Fabricante:</b> Tekne Dental (TKD®)      <b>Garantía:</b> 12 meses</p> <p><b>Ref.:</b> <b>40-12K1000</b></p>	<p><b>Longitud:</b> 93cm  <b>Color:</b> Gris claro (RAL 9002)  <b>Resistencia:</b> 430 Ohm</p>

**Conexión Abierta / Open End****Características**

	<p><b>Conexión instrumento:</b> Satelec® Newtron/Suprasson, sin luz</p> <p><b>Conexión equipo:</b> Abierta</p> <p><b>Origen:</b> Italia      <b>Fabricante:</b> Tekne Dental (TKD®)      <b>Garantía:</b> 12 meses</p> <p><b>Ref.:</b> <b>40-71B1100</b></p>	<p><b>Longitud:</b> 200cm</p> <p><b>Color:</b> Gris claro (RAL 9002)</p> <p><b>Diámetro:</b> 9mm (STANDARD)</p>
	<p><b>Conexión instrumento:</b> Satelec® Newtron/Suprasson, sin luz</p> <p><b>Conexión equipo:</b> Abierta</p> <p><b>Origen:</b> Italia      <b>Fabricante:</b> Tekne Dental (TKD®)      <b>Garantía:</b> 12 meses</p> <p><b>Ref.:</b> <b>40-71B2100</b></p>	<p><b>Longitud:</b> 200cm</p> <p><b>Color:</b> Gris oscuro (RAL 7038)</p> <p><b>Diámetro:</b> 9mm (STANDARD)</p>
	<p><b>Conexión instrumento:</b> Satelec® Newtron/Suprasson, sin luz</p> <p><b>Conexión equipo:</b> Abierta</p> <p><b>Origen:</b> Italia      <b>Fabricante:</b> Tekne Dental (TKD®)      <b>Garantía:</b> 12 meses</p> <p><b>Ref.:</b> <b>40-71B1110</b></p>	<p><b>Longitud:</b> 200cm</p> <p><b>Color:</b> Gris claro (RAL 9002)</p> <p><b>Diámetro:</b> 7mm (FINA)</p>
	<p><b>Conexión instrumento:</b> Satelec® Newtron/Suprasson, sin luz</p> <p><b>Conexión equipo:</b> Abierta</p> <p><b>Origen:</b> Italia      <b>Fabricante:</b> Tekne Dental (TKD®)      <b>Garantía:</b> 12 meses</p> <p><b>Ref.:</b> <b>40-71B2110</b></p>	<p><b>Longitud:</b> 200cm</p> <p><b>Color:</b> Gris oscuro (RAL 7038)</p> <p><b>Diámetro:</b> 7mm (FINA)</p>
 	<p><b>Conexión instrumento:</b> Satelec® Newtron/Suprasson, sin luz</p> <p><b>Conexión equipo:</b> Satelec® Newtron/Suprasson, sin luz</p> <p><b>Origen:</b> Italia      <b>Fabricante:</b> Tekne Dental (TKD®)      <b>Garantía:</b> 12 meses</p> <p><b>Ref.:</b> <b>40-71B1111</b></p>	<p><b>Longitud:</b> 200cm</p> <p><b>Color:</b> Gris claro (RAL 9002)</p> <p><b>Diámetro:</b> 7mm (FINA)</p>
	<p><b>Conexión instrumento:</b> Satelec® Newtron/Suprasson, con luz</p> <p><b>Conexión equipo:</b> Abierta</p> <p><b>Origen:</b> Italia      <b>Fabricante:</b> Tekne Dental (TKD®)      <b>Garantía:</b> 12 meses</p> <p><b>Ref.:</b> <b>40-71B1120</b></p>	<p><b>Longitud:</b> 200cm</p> <p><b>Color:</b> Gris claro (RAL 9002)</p> <p><b>Diámetro:</b> 7mm (FINA)</p>
	<p><b>Conexión instrumento:</b> Satelec® Newtron/Suprasson, con luz</p> <p><b>Conexión equipo:</b> Abierta</p> <p><b>Origen:</b> Italia      <b>Fabricante:</b> Tekne Dental (TKD®)      <b>Garantía:</b> 12 meses</p> <p><b>Ref.:</b> <b>40-71B1130</b></p>	<p><b>Longitud:</b> 200cm</p> <p><b>Color:</b> Gris claro (RAL 9002)</p> <p><b>Diámetro:</b> 9mm (STANDARD)</p>
	<p><b>Conexión instrumento:</b> EMS Piezon, sin luz</p> <p><b>Conexión equipo:</b> Abierta</p> <p><b>Origen:</b> Italia      <b>Fabricante:</b> Tekne Dental (TKD®)      <b>Garantía:</b> 12 meses</p> <p><b>Ref.:</b> <b>40-71B1200</b></p>	<p><b>Longitud:</b> 200cm</p> <p><b>Color:</b> Gris claro (RAL 9002)</p> <p><b>Diámetro:</b> 9mm (STANDARD)</p>
	<p><b>Conexión instrumento:</b> EMS Piezon, sin luz</p> <p><b>Conexión equipo:</b> Abierta</p> <p><b>Origen:</b> Italia      <b>Fabricante:</b> Tekne Dental (TKD®)      <b>Garantía:</b> 12 meses</p> <p><b>Ref.:</b> <b>40-71B2200</b></p>	<p><b>Longitud:</b> 200cm</p> <p><b>Color:</b> Gris oscuro (RAL 7038)</p> <p><b>Diámetro:</b> 9mm (STANDARD)</p>
	<p><b>Conexión instrumento:</b> EMS Piezon, sin luz</p> <p><b>Conexión equipo:</b> Abierta</p> <p><b>Origen:</b> Italia      <b>Fabricante:</b> Tekne Dental (TKD®)      <b>Garantía:</b> 12 meses</p> <p><b>Ref.:</b> <b>40-71B1210</b></p>	<p><b>Longitud:</b> 200cm</p> <p><b>Color:</b> Gris claro (RAL 9002)</p> <p><b>Diámetro:</b> 7mm (FINA)</p>

## Conexión Abierta / Open End

## Características

	<p><b>Conexión instrumento:</b> EMS Piezon, sin luz <b>Conexión equipo:</b> Abierta</p> <p><b>Origen:</b> Italia      <b>Fabricante:</b> Tekne Dental (TKD®)      <b>Garantía:</b> 12 meses</p> <p><b>Ref.:</b> <b>40-71B2210</b></p>	<p><b>Longitud:</b> 200cm <b>Color:</b> Gris oscuro (RAL 7038) <b>Diámetro:</b> 7mm (FINA)</p> <p><b>88'00€</b></p>
 	<p><b>Conexión instrumento:</b> EMS Piezon, sin luz <b>Conexión equipo:</b> EMS Piezon, sin luz</p> <p><b>Origen:</b> Italia      <b>Fabricante:</b> Tekne Dental (TKD®)      <b>Garantía:</b> 12 meses</p> <p><b>Ref.:</b> <b>40-71B1211</b></p>	<p><b>Longitud:</b> 200cm <b>Color:</b> Gris claro (RAL 9002) <b>Diámetro:</b> 7mm (FINA)</p> <p><b>141'80€</b></p>
	<p><b>Conexión instrumento:</b> EMS Piezon, con luz <b>Conexión equipo:</b> Abierta</p> <p><b>Origen:</b> Italia      <b>Fabricante:</b> Tekne Dental (TKD®)      <b>Garantía:</b> 12 meses</p> <p><b>Ref.:</b> <b>40-71B1220</b></p>	<p><b>Longitud:</b> 200cm <b>Color:</b> Gris claro (RAL 9002) <b>Diámetro:</b> 7mm (FINA)</p> <p><b>131'80€</b></p>
	<p><b>Conexión instrumento:</b> EMS Piezon, con luz <b>Conexión equipo:</b> Abierta</p> <p><b>Origen:</b> Italia      <b>Fabricante:</b> Tekne Dental (TKD®)      <b>Garantía:</b> 12 meses</p> <p><b>Ref.:</b> <b>40-71B1230</b></p>	<p><b>Longitud:</b> 200cm <b>Color:</b> Gris claro (RAL 9002) <b>Diámetro:</b> 9mm (STANDARD)</p> <p><b>131'80€</b></p>
 	<p><b>Conexión instrumento:</b> EMS Piezon, sin luz <b>Conexión equipo:</b> Abierta</p> <p><b>Origen:</b> China      <b>Fabricante:</b> Woodpecker®      <b>Garantía:</b> 6 meses</p> <p><b>Ref.:</b> <b>28-U007</b></p>	<p><b>Longitud:</b> 200cm <b>Color:</b> Gris claro (RAL 9002) <b>Diámetro:</b> 7mm (FINA)</p> <p><b>39'80€</b></p>
 	<p><b>Conexión instrumento:</b> EMS Piezon, con luz <b>Conexión equipo:</b> Abierta</p> <p><b>Origen:</b> China      <b>Fabricante:</b> Woodpecker®      <b>Garantía:</b> 6 meses</p> <p><b>Ref.:</b> <b>28-U010</b></p>	<p><b>Longitud:</b> 200cm <b>Color:</b> Gris claro (RAL 9002) <b>Diámetro:</b> 7mm (FINA)</p> <p><b>50'80€</b></p>
 	<p><b>Conexión instrumento:</b> Satelec® Newtron/Suprasson, sin luz <b>Conexión equipo:</b> Abierta</p> <p><b>Origen:</b> China      <b>Fabricante:</b> Woodpecker®      <b>Garantía:</b> 6 meses</p> <p><b>Ref.:</b> <b>28-U008</b></p>	<p><b>Longitud:</b> 200cm <b>Color:</b> Gris claro (RAL 9002) <b>Diámetro:</b> 7mm (FINA)</p> <p><b>39'80€</b></p>
 	<p><b>Conexión instrumento:</b> Satelec® Newtron/Suprasson, con luz <b>Conexión equipo:</b> Abierta</p> <p><b>Origen:</b> China      <b>Fabricante:</b> Woodpecker®      <b>Garantía:</b> 6 meses</p> <p><b>Ref.:</b> <b>28-U009</b></p>	<p><b>Longitud:</b> 200cm <b>Color:</b> Gris claro (RAL 9002) <b>Diámetro:</b> 7mm (FINA)</p> <p><b>50'80€</b></p>
	<p><b>Conexión instrumento:</b> Mectron, sin luz <b>Conexión equipo:</b> Abierta</p> <p><b>Origen:</b> Italia      <b>Fabricante:</b> Tekne Dental (TKD®)      <b>Garantía:</b> 12 meses</p> <p><b>Ref.:</b> <b>40-71N2300</b></p>	<p><b>Longitud:</b> 200cm <b>Color:</b> Gris oscuro (RAL 7038) <b>Diámetro:</b> 9mm (STANDARD)</p> <p><b>108'00€</b></p>
	<p><b>Conexión instrumento:</b> PiezoLED, con luz <b>Conexión equipo:</b> Abierta</p> <p><b>Origen:</b> Italia      <b>Fabricante:</b> Tekne Dental (TKD®)      <b>Garantía:</b> 12 meses</p> <p><b>Ref.:</b> <b>40-71A6500</b></p>	<p><b>Longitud:</b> 160cm <b>Color:</b> Gris medio (RAL 7035) <b>Diámetro:</b> 9mm (STANDARD) <b>Regulación de spray</b></p> <p><b>208'00€</b></p>

**Conexión Abierta / Open End**

**Características**



**Conexión instrumento:** TKD® (conexión TKD), sin luz  
**Conexión equipo:** Abierta

**Origen:** Italia      **Fabricante:** Tekne Dental (TKD®)      **Garantía:** 12 meses

**Ref.:** 40-71A2400

64´80€

**Longitud:** 160cm  
**Color:** Gris oscuro (RAL 7038)

**Mangueras para Ultrasonidos: Conector a equipo KaVo®**



**Conector a equipo KaVo®**

**Características**

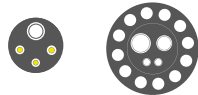

**Conexión instrumento:** EMS Piezon, sin luz  
**Conexión equipo:** KaVo® 1058\*, 1062, 1063, 1065, 1966, 1078 y 1080 (Serie 1) (\*Excepto 1058TM Primus Life)

**Origen:** Italia      **Fabricante:** Tekne Dental (TKD®)      **Garantía:** 12 meses

**Ref.:** 40-72G6201

128´00€

BAJO PEDIDO

**Longitud:** 120cm  
**Color:** Gris medio (RAL 7035)  
**Diámetro:** 9mm (STANDARD)

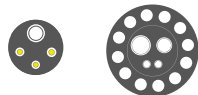

**Conexión instrumento:** EMS Piezon, sin luz,  
**Conexión equipo:** KaVo® 1058\*, 1062, 1063, 1065, 1966, 1078 y 1080 (Serie 1) (\*Excepto 1058TM Primus Life)

**Origen:** Italia      **Fabricante:** Tekne Dental (TKD®)      **Garantía:** 12 meses

**Ref.:** 40-72E6201

128´00€

BAJO PEDIDO

**Longitud:** 135cm  
**Color:** Gris medio (RAL 7035)  
**Diámetro:** 9mm (STANDARD)



**Conexión instrumento:** EMS Piezon, sin luz  
**Conexión equipo:** KaVo® 1058\*, 1062, 1063, 1065, 1966, 1078 y 1080 (Serie 1) (\*Excepto 1058TM Primus Life)

**Origen:** Italia      **Fabricante:** Tekne Dental (TKD®)      **Garantía:** 12 meses

**Ref.:** 40-72G6202

288´00€

BAJO PEDIDO

**Longitud:** 120cm  
**Color:** Gris medio (RAL 7035)  
**Diámetro:** 9mm (STANDARD)  
**Regulación de spray**



**Conexión instrumento:** EMS Piezon, sin luz  
**Conexión equipo:** KaVo® 1058\*, 1062, 1063, 1065, 1966, 1078 y 1080 (Serie 1) (\*Excepto 1058TM Primus Life)

**Origen:** Italia      **Fabricante:** Tekne Dental (TKD®)      **Garantía:** 12 meses

**Ref.:** 40-72E6202

288´00€

BAJO PEDIDO

**Longitud:** 135cm  
**Color:** Gris medio (RAL 7035)  
**Diámetro:** 9mm (STANDARD)  
**Regulación de spray**



**Conexión instrumento:** EMS Piezon, sin luz  
**Conexión equipo:** KaVo® E30, E50, E70, E80 y 1058 Primus Life (Serie 2)

**Origen:** Italia      **Fabricante:** Tekne Dental (TKD®)      **Garantía:** 12 meses

**Ref.:** 40-72G6200

138´00€

**Longitud:** 120cm  
**Color:** Gris medio (RAL 7035)  
**Diámetro:** 9mm (STANDARD)



**Conexión instrumento:** EMS Piezon, sin luz  
**Conexión equipo:** KaVo® E30, E50, E70, E80 y 1058 Primus Life (Serie 2)

**Origen:** Italia      **Fabricante:** Tekne Dental (TKD®)      **Garantía:** 12 meses

**Ref.:** 40-72E6200

138´00€

BAJO PEDIDO

**Longitud:** 135cm  
**Color:** Gris medio (RAL 7035)  
**Diámetro:** 9mm (STANDARD)



**Conexión instrumento:** EMS Piezon, sin luz  
**Conexión equipo:** KaVo® E30, E50, E70, E80 y 1058 Primus Life (Serie 2)

**Origen:** Italia      **Fabricante:** Tekne Dental (TKD®)      **Garantía:** 12 meses

**Ref.:** 40-72G6203

299´80€

BAJO PEDIDO

**Longitud:** 120cm  
**Color:** Gris medio (RAL 7035)  
**Diámetro:** 9mm (STANDARD)  
**Regulación de spray**



**Conexión instrumento:** EMS Piezon, sin luz  
**Conexión equipo:** KaVo® E30, E50, E70, E80 y 1058 Primus Life (Serie 2)

**Origen:** Italia      **Fabricante:** Tekne Dental (TKD®)      **Garantía:** 12 meses

**Ref.:** 40-72E6203

299´80€

BAJO PEDIDO

**Longitud:** 135cm  
**Color:** Gris medio (RAL 7035)  
**Diámetro:** 9mm (STANDARD)  
**Regulación de spray**



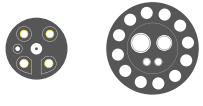
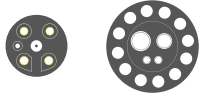
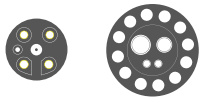
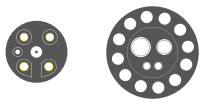
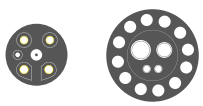
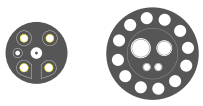
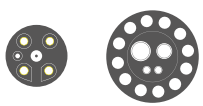
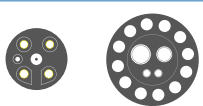
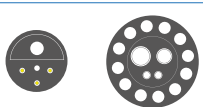
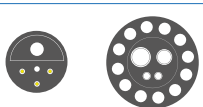

## Conector a equipo KaVo®

## Características

	<p><b>Conexión instrumento:</b> EMS Piezon, con luz</p> <p><b>Conexión equipo:</b> KaVo® 1058*, 1062, 1063, 1065, 1966, 1078 y 1080 (Serie 1) (*Excepto 1058TM Primus Life)</p> <p><b>Origen:</b> Italia      <b>Fabricante:</b> Tekne Dental (TKD®)      <b>Garantía:</b> 12 meses</p> <p><b>Ref.:</b> <b>40-72G6221</b></p>	<p><b>Longitud:</b> 120cm</p> <p><b>Color:</b> Gris medio (RAL 7035)</p> <p><b>Diámetro:</b> 9mm (STANDARD)</p>	<p><b>178´00€</b></p> <p><b>BAJO PEDIDO</b></p>
	<p><b>Conexión instrumento:</b> EMS Piezon, con luz</p> <p><b>Conexión equipo:</b> KaVo® 1058*, 1062, 1063, 1065, 1966, 1078 y 1080 (Serie 1) (*Excepto 1058TM Primus Life)</p> <p><b>Origen:</b> Italia      <b>Fabricante:</b> Tekne Dental (TKD®)      <b>Garantía:</b> 12 meses</p> <p><b>Ref.:</b> <b>40-72E6221</b></p>	<p><b>Longitud:</b> 135cm</p> <p><b>Color:</b> Gris medio (RAL 7035)</p> <p><b>Diámetro:</b> 9mm (STANDARD)</p>	<p><b>178´00€</b></p> <p><b>BAJO PEDIDO</b></p>
	<p><b>Conexión instrumento:</b> EMS Piezon, con luz</p> <p><b>Conexión equipo:</b> KaVo® 1058*, 1062, 1063, 1065, 1966, 1078 y 1080 (Serie 1) (*Excepto 1058TM Primus Life)</p> <p><b>Origen:</b> Italia      <b>Fabricante:</b> Tekne Dental (TKD®)      <b>Garantía:</b> 12 meses</p> <p><b>Ref.:</b> <b>40-72G6222</b></p>	<p><b>Longitud:</b> 120cm</p> <p><b>Color:</b> Gris medio (RAL 7035)</p> <p><b>Diámetro:</b> 9mm (STANDARD)</p> <p><b>Regulación de spray</b></p>	<p><b>338´00€</b></p> <p><b>BAJO PEDIDO</b></p>
	<p><b>Conexión instrumento:</b> EMS Piezon, con luz</p> <p><b>Conexión equipo:</b> KaVo® 1058*, 1062, 1063, 1065, 1966, 1078 y 1080 (Serie 1) (*Excepto 1058TM Primus Life)</p> <p><b>Origen:</b> Italia      <b>Fabricante:</b> Tekne Dental (TKD®)      <b>Garantía:</b> 12 meses</p> <p><b>Ref.:</b> <b>40-72E6222</b></p>	<p><b>Longitud:</b> 135cm</p> <p><b>Color:</b> Gris medio (RAL 7035)</p> <p><b>Diámetro:</b> 9mm (STANDARD)</p> <p><b>Regulación de spray</b></p>	<p><b>338´00€</b></p> <p><b>BAJO PEDIDO</b></p>
	<p><b>Conexión instrumento:</b> EMS Piezon, con luz</p> <p><b>Conexión equipo:</b> KaVo® E30, E50, E70, E80 y 1058 Primus Life (Serie 2)</p> <p><b>Origen:</b> Italia      <b>Fabricante:</b> Tekne Dental (TKD®)      <b>Garantía:</b> 12 meses</p> <p><b>Ref.:</b> <b>40-72G6223</b></p>	<p><b>Longitud:</b> 120cm</p> <p><b>Color:</b> Gris medio (RAL 7035)</p> <p><b>Diámetro:</b> 9mm (STANDARD)</p>	<p><b>178´00€</b></p> <p><b>BAJO PEDIDO</b></p>
	<p><b>Conexión instrumento:</b> EMS Piezon, con luz</p> <p><b>Conexión equipo:</b> KaVo® E30, E50, E70, E80 y 1058 Primus Life (Serie 2)</p> <p><b>Origen:</b> Italia      <b>Fabricante:</b> Tekne Dental (TKD®)      <b>Garantía:</b> 12 meses</p> <p><b>Ref.:</b> <b>40-72E6223</b></p>	<p><b>Longitud:</b> 135cm</p> <p><b>Color:</b> Gris medio (RAL 7035)</p> <p><b>Diámetro:</b> 9mm (STANDARD)</p>	<p><b>168´00€</b></p> <p><b>BAJO PEDIDO</b></p>
	<p><b>Conexión instrumento:</b> EMS Piezon, con luz</p> <p><b>Conexión equipo:</b> KaVo® E30, E50, E70, E80 y 1058 Primus Life (Serie 2)</p> <p><b>Origen:</b> Italia      <b>Fabricante:</b> Tekne Dental (TKD®)      <b>Garantía:</b> 12 meses</p> <p><b>Ref.:</b> <b>40-72G6224</b></p>	<p><b>Longitud:</b> 120cm</p> <p><b>Color:</b> Gris medio (RAL 7035)</p> <p><b>Diámetro:</b> 9mm (STANDARD)</p> <p><b>Regulación de spray</b></p>	<p><b>348´00€</b></p> <p><b>BAJO PEDIDO</b></p>
	<p><b>Conexión instrumento:</b> EMS Piezon, con luz</p> <p><b>Conexión equipo:</b> KaVo® E30, E50, E70, E80 y 1058 Primus Life (Serie 2)</p> <p><b>Origen:</b> Italia      <b>Fabricante:</b> Tekne Dental (TKD®)      <b>Garantía:</b> 12 meses</p> <p><b>Ref.:</b> <b>40-72E6224</b></p>	<p><b>Longitud:</b> 135cm</p> <p><b>Color:</b> Gris medio (RAL 7035)</p> <p><b>Diámetro:</b> 9mm (STANDARD)</p> <p><b>Regulación de spray</b></p>	<p><b>348´00€</b></p> <p><b>BAJO PEDIDO</b></p>
	<p><b>Conexión instrumento:</b> Satelec® Newtron/Suprasson, sin luz</p> <p><b>Conexión equipo:</b> KaVo® 1058*, 1062, 1063, 1065, 1966, 1078 y 1080 (Serie 1) (*Excepto 1058TM Primus Life)</p> <p><b>Origen:</b> Italia      <b>Fabricante:</b> Tekne Dental (TKD®)      <b>Garantía:</b> 12 meses</p> <p><b>Ref.:</b> <b>40-72G6101</b></p>	<p><b>Longitud:</b> 120cm</p> <p><b>Color:</b> Gris medio (RAL 7035)</p> <p><b>Diámetro:</b> 9mm (STANDARD)</p>	<p><b>128´00€</b></p> <p><b>BAJO PEDIDO</b></p>
	<p><b>Conexión instrumento:</b> Satelec® Newtron/Suprasson, sin luz</p> <p><b>Conexión equipo:</b> KaVo® 1058*, 1062, 1063, 1065, 1966, 1078 y 1080 (Serie 1) (*Excepto 1058TM Primus Life)</p> <p><b>Origen:</b> Italia      <b>Fabricante:</b> Tekne Dental (TKD®)      <b>Garantía:</b> 12 meses</p> <p><b>Ref.:</b> <b>40-72E6101</b></p>	<p><b>Longitud:</b> 135cm</p> <p><b>Color:</b> Gris medio (RAL 7035)</p> <p><b>Diámetro:</b> 9mm (STANDARD)</p>	<p><b>128´00€</b></p> <p><b>BAJO PEDIDO</b></p>

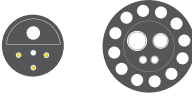
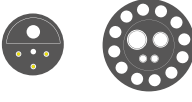
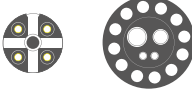
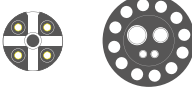
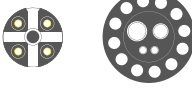
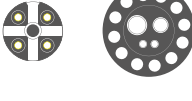

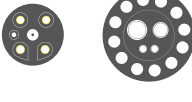
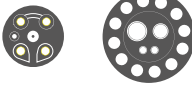

















**Conector a equipo KaVo®**

**Características**

	<p><b>Conexión instrumento:</b> Satelec® Newtron/Suprasson, sin luz  <b>Conexión equipo:</b> KaVo® E30, E50, E70, E80 y 1058 Primus Life (Serie 2)</p> <p><b>Origen:</b> Italia      <b>Fabricante:</b> Tekne Dental (TKD®)      <b>Garantía:</b> 12 meses</p> <p><b>Ref.:</b> <b>40-72G6100</b></p>	<p><b>Longitud:</b> 120cm  <b>Color:</b> Gris medio (RAL 7035)  <b>Diámetro:</b> 9mm (STANDARD)</p>	
	<p><b>Conexión instrumento:</b> Satelec® Newtron/Suprasson, sin luz  <b>Conexión equipo:</b> KaVo® E30, E50, E70, E80 y 1058 Primus Life (Serie 2)</p> <p><b>Origen:</b> Italia      <b>Fabricante:</b> Tekne Dental (TKD®)      <b>Garantía:</b> 12 meses</p> <p><b>Ref.:</b> <b>40-72E6100</b></p>	<p><b>Longitud:</b> 135cm  <b>Color:</b> Gris medio (RAL 7035)  <b>Diámetro:</b> 9mm (STANDARD)</p>	
	<p><b>Conexión instrumento:</b> Satelec® Newtron/Suprasson, con luz  <b>Conexión equipo:</b> KaVo® 1058*, 1062, 1063, 1065, 1966, 1078 y 1080 (Serie 1) (*Excepto 1058TM Primus Life)</p> <p><b>Origen:</b> Italia      <b>Fabricante:</b> Tekne Dental (TKD®)      <b>Garantía:</b> 12 meses</p> <p><b>Ref.:</b> <b>40-72G6111</b></p>	<p><b>Longitud:</b> 120cm  <b>Color:</b> Gris medio (RAL 7035)  <b>Diámetro:</b> 9mm (STANDARD)</p> <p style="text-align: right;"><b>BAJO PEDIDO</b></p>	
	<p><b>Conexión instrumento:</b> Satelec® Newtron/Suprasson, con luz  <b>Conexión equipo:</b> KaVo® 1058*, 1062, 1063, 1065, 1966, 1078 y 1080 (Serie 1) (*Excepto 1058TM Primus Life)</p> <p><b>Origen:</b> Italia      <b>Fabricante:</b> Tekne Dental (TKD®)      <b>Garantía:</b> 12 meses</p> <p><b>Ref.:</b> <b>40-72E6111</b></p>	<p><b>Longitud:</b> 135cm  <b>Color:</b> Gris medio (RAL 7035)  <b>Diámetro:</b> 9mm (STANDARD)</p> <p style="text-align: right;"><b>BAJO PEDIDO</b></p>	
	<p><b>Conexión instrumento:</b> Satelec® Newtron/Suprasson, con luz  <b>Conexión equipo:</b> KaVo® E30, E50, E70, E80 (Serie 2)</p> <p><b>Origen:</b> Italia      <b>Fabricante:</b> Tekne Dental (TKD®)      <b>Garantía:</b> 12 meses</p> <p><b>Ref.:</b> <b>40-72G6112</b></p>	<p><b>Longitud:</b> 120cm  <b>Color:</b> Gris medio (RAL 7035)  <b>Diámetro:</b> 9mm (STANDARD)</p> <p style="text-align: right;"><b>BAJO PEDIDO</b></p>	
	<p><b>Conexión instrumento:</b> Satelec® Newtron/Suprasson, con luz  <b>Conexión equipo:</b> KaVo® E30, E50, E70, E80 (Serie 2)</p> <p><b>Origen:</b> Italia      <b>Fabricante:</b> Tekne Dental (TKD®)      <b>Garantía:</b> 12 meses</p> <p><b>Ref.:</b> <b>40-72E6112</b></p>	<p><b>Longitud:</b> 135cm  <b>Color:</b> Gris medio (RAL 7035)  <b>Diámetro:</b> 9mm (STANDARD)</p> <p style="text-align: right;"><b>BAJO PEDIDO</b></p>	
<p style="writing-mode: vertical-rl; transform: rotate(180deg);"><b>NUEVO</b></p>		<p><b>Conexión instrumento:</b> PiezoSOFT, con luz  <b>Conexión equipo:</b> KaVo® E30, E50, E70, E80 (Serie 2)</p> <p><b>Origen:</b> Italia      <b>Fabricante:</b> Tekne Dental (TKD®)      <b>Garantía:</b> 12 meses</p> <p><b>Ref.:</b> <b>40-72G6600</b></p>	<p><b>Longitud:</b> 120cm  <b>Color:</b> Gris medio (RAL 7035)</p>
<p style="writing-mode: vertical-rl; transform: rotate(180deg);"><b>NUEVO</b></p>		<p><b>Conexión instrumento:</b> PiezoSOFT, con luz  <b>Conexión equipo:</b> KaVo® E30, E50, E70, E80 (Serie 2)</p> <p><b>Origen:</b> Italia      <b>Fabricante:</b> Tekne Dental (TKD®)      <b>Garantía:</b> 12 meses</p> <p><b>Ref.:</b> <b>40-72E6600</b></p>	<p><b>Longitud:</b> 135cm  <b>Color:</b> Gris medio (RAL 7035)</p>
<p style="writing-mode: vertical-rl; transform: rotate(180deg);"><b>NUEVO</b></p>		<p><b>Conexión instrumento:</b> PiezoLED, con luz  <b>Conexión equipo:</b> KaVo® E30, E50, E70, E80 (Serie 2)</p> <p><b>Origen:</b> Italia      <b>Fabricante:</b> Tekne Dental (TKD®)      <b>Garantía:</b> 12 meses</p> <p><b>Ref.:</b> <b>40-72G6500</b></p>	<p><b>Longitud:</b> 120cm  <b>Color:</b> Gris medio (RAL 7035)  <b>Regulación de spray</b></p>
<p style="writing-mode: vertical-rl; transform: rotate(180deg);"><b>NUEVO</b></p>		<p><b>Conexión instrumento:</b> PiezoLED, con luz  <b>Conexión equipo:</b> KaVo® E30, E50, E70, E80 (Serie 2)</p> <p><b>Origen:</b> Italia      <b>Fabricante:</b> Tekne Dental (TKD®)      <b>Garantía:</b> 12 meses</p> <p><b>Ref.:</b> <b>40-72E6500</b></p>	<p><b>Longitud:</b> 135cm  <b>Color:</b> Gris medio (RAL 7035)  <b>Regulación de spray</b></p>

## Conector a equipo Cefla® (desde 2006), Castellini, Anthos, Stern Weber

## Características

 	<p><b>Conexión instrumento:</b> Satelec® Newtron/Suprasson, sin luz</p> <p><b>Conexión equipo Cefla® (desde 2006):</b>  <b>Anthos®:</b> A3, A5, A6, A7, A9, L6, L9, R7; <b>Stern Weber®:</b> S200, S220TR S250, S280TRC, S300, 320TR, S320TR, S380TRC;  <b>Castellini®:</b> SKEMA 5, SKEMA 6, SKEMA 8</p> <p><b>Origen:</b> Italia <b>Fabricante:</b> Tekne Dental (TKD®) <b>Garantía:</b> 12 meses</p> <p><b>Ref.:</b> <b>40-72E2100</b></p>	<p><b>Longitud:</b> 135cm  <b>Color:</b> Gris oscuro (RAL 7038)</p> <p><b>128´00€</b></p>
 	<p><b>Conexión instrumento:</b> Satelec® Newtron/Suprasson, sin luz</p> <p><b>Conexión equipo Cefla® (desde 2006):</b>  <b>Anthos®:</b> A3, A5, A6, A7, A9, L6, L9, R7; <b>Stern Weber®:</b> S200, S220TR S250, S280TRC, S300, 320TR, S320TR, S380TRC;  <b>Castellini®:</b> SKEMA 5, SKEMA 6, SKEMA 8</p> <p><b>Origen:</b> Italia <b>Fabricante:</b> Tekne Dental (TKD®) <b>Garantía:</b> 12 meses</p> <p><b>Ref.:</b> <b>40-72G2100</b></p>	<p><b>Longitud:</b> 120cm  <b>Color:</b> Gris oscuro (RAL 7038)</p> <p><b>108´00€</b></p>
 	<p><b>Conexión instrumento:</b> Satelec® Newtron/Suprasson LED, con luz</p> <p><b>Conexión equipo Cefla® (desde 2006):</b>  <b>Anthos®:</b> A3, A5, A6, A7, A9, L6, L9, R7; <b>Stern Weber®:</b> S200, S220TR S250, S280TRC, S300, 320TR, S320TR, S380TRC;  <b>Castellini®:</b> SKEMA 5, SKEMA 6, SKEMA 8</p> <p><b>Origen:</b> Italia <b>Fabricante:</b> Tekne Dental (TKD®) <b>Garantía:</b> 12 meses</p> <p><b>Ref.:</b> <b>40-72E2120</b></p>	<p><b>Longitud:</b> 135cm  <b>Color:</b> Gris oscuro (RAL 7038)</p> <p><b>188´00€</b></p> <p><b>BAJO PEDIDO</b></p>
 	<p><b>Conexión instrumento:</b> Satelec® Newtron/Suprasson LED, con luz</p> <p><b>Conexión equipo Cefla® (desde 2006):</b>  <b>Anthos®:</b> A3, A5, A6, A7, A9, L6, L9, R7; <b>Stern Weber®:</b> S200, S220TR S250, S280TRC, S300, 320TR, S320TR, S380TRC;  <b>Castellini®:</b> SKEMA 5, SKEMA 6, SKEMA 8</p> <p><b>Origen:</b> Italia <b>Fabricante:</b> Tekne Dental (TKD®) <b>Garantía:</b> 12 meses</p> <p><b>Ref.:</b> <b>40-72G2120</b></p>	<p><b>Longitud:</b> 120cm  <b>Color:</b> Gris oscuro (RAL 7038)</p> <p><b>198´00€</b></p> <p><b>BAJO PEDIDO</b></p>
 	<p><b>Conexión instrumento:</b> EMS Piezon, sin luz</p> <p><b>Conexión equipo Cefla® (desde 2006):</b>  <b>Anthos®:</b> A3, A5, A6, A7, A9, L6, L9, R7; <b>Stern Weber®:</b> S200, S220TR S250, S280TRC, S300, 320TR, S320TR, S380TRC;  <b>Castellini®:</b> SKEMA 5, SKEMA 6, SKEMA 8</p> <p><b>Origen:</b> Italia <b>Fabricante:</b> Tekne Dental (TKD®) <b>Garantía:</b> 12 meses</p> <p><b>Ref.:</b> <b>40-72E2200</b></p>	<p><b>Longitud:</b> 135cm  <b>Color:</b> Gris oscuro (RAL 7038)</p> <p><b>108´00€</b></p>
 	<p><b>Conexión instrumento:</b> EMS Piezon, sin luz</p> <p><b>Conexión equipo Cefla® (desde 2006):</b>  <b>Anthos®:</b> A3, A5, A6, A7, A9, L6, L9, R7; <b>Stern Weber®:</b> S200, S220TR S250, S280TRC, S300, 320TR, S320TR, S380TRC;  <b>Castellini®:</b> SKEMA 5, SKEMA 6, SKEMA 8</p> <p><b>Origen:</b> Italia <b>Fabricante:</b> Tekne Dental (TKD®) <b>Garantía:</b> 12 meses</p> <p><b>Ref.:</b> <b>40-72G2200</b></p>	<p><b>Longitud:</b> 120cm  <b>Color:</b> Gris oscuro (RAL 7038)</p> <p><b>128´00€</b></p>
 	<p><b>Conexión instrumento:</b> EMS Piezon LED, con luz</p> <p><b>Conexión equipo Cefla® (desde 2006):</b>  <b>Anthos®:</b> A3, A5, A6, A7, A9, L6, L9, R7; <b>Stern Weber®:</b> S200, S220TR S250, S280TRC, S300, 320TR, S320TR, S380TRC;  <b>Castellini®:</b> SKEMA 5, SKEMA 6, SKEMA 8</p> <p><b>Origen:</b> Italia <b>Fabricante:</b> Tekne Dental (TKD®) <b>Garantía:</b> 12 meses</p> <p><b>Ref.:</b> <b>40-72E2220</b></p>	<p><b>Longitud:</b> 135cm  <b>Color:</b> Gris oscuro (RAL 7038)</p> <p><b>178´00€</b></p> <p><b>BAJO PEDIDO</b></p>
 	<p><b>Conexión instrumento:</b> EMS Piezon LED, con luz</p> <p><b>Conexión equipo Cefla® (desde 2006):</b>  <b>Anthos®:</b> A3, A5, A6, A7, A9, L6, L9, R7; <b>Stern Weber®:</b> S200, S220TR S250, S280TRC, S300, 320TR, S320TR, S380TRC;  <b>Castellini®:</b> SKEMA 5, SKEMA 6, SKEMA 8</p> <p><b>Origen:</b> Italia <b>Fabricante:</b> Tekne Dental (TKD®) <b>Garantía:</b> 12 meses</p> <p><b>Ref.:</b> <b>40-72G2220</b></p>	<p><b>Longitud:</b> 120cm  <b>Color:</b> Gris oscuro (RAL 7038)</p> <p><b>178´00€</b></p> <p><b>BAJO PEDIDO</b></p>
 	<p><b>Conexión instrumento:</b> EMS Piezon LED, con luz</p> <p><b>Conexión equipo Cefla® (desde 2006):</b>  <b>Anthos®:</b> A3, A5, A6, A7, A9, L6, L9, R7; <b>Stern Weber®:</b> S200, S220TR S250, S280TRC, S300, 320TR, S320TR, S380TRC;  <b>Castellini®:</b> SKEMA 5, SKEMA 6, SKEMA 8</p> <p><b>Origen:</b> Italia <b>Fabricante:</b> Tekne Dental (TKD®) <b>Garantía:</b> 12 meses</p> <p><b>Ref.:</b> <b>40-72E2221</b></p>	<p><b>Longitud:</b> 135cm  <b>Color:</b> Gris oscuro (RAL 7038)  <b>Regulación de spray</b></p> <p><b>348´00€</b></p> <p><b>BAJO PEDIDO</b></p>
 	<p><b>Conexión instrumento:</b> EMS Piezon LED, con luz</p> <p><b>Conexión equipo Cefla® (desde 2006):</b>  <b>Anthos®:</b> A3, A5, A6, A7, A9, L6, L9, R7; <b>Stern Weber®:</b> S200, S220TR S250, S280TRC, S300, 320TR, S320TR, S380TRC;  <b>Castellini®:</b> SKEMA 5, SKEMA 6, SKEMA 8</p> <p><b>Origen:</b> Italia <b>Fabricante:</b> Tekne Dental (TKD®) <b>Garantía:</b> 12 meses</p> <p><b>Ref.:</b> <b>40-72G2221</b></p>	<p><b>Longitud:</b> 120cm  <b>Color:</b> Gris oscuro (RAL 7038)  <b>Regulación de spray</b></p> <p><b>348´00€</b></p> <p><b>BAJO PEDIDO</b></p>

## Mangueras para Ultrasonidos: Conector a equipo Planmeca®

RUMAR



Conexión a equipo Planmeca®		Características
	<b>Conexión instrumento:</b> EMS Piezon, sin luz <b>Conexión equipo:</b> Planmeca®	<b>Longitud:</b> 93cm <b>Color:</b> Gris claro (RAL 9002) <b>Diámetro:</b> 7mm <b>Resistencia:</b> 1300 Ohm
	<b>Origen:</b> Italia <b>Fabricante:</b> Tekne Dental (TKD®) <b>Garantía:</b> 12 meses <b>Ref.:</b> <b>40-72K1210</b> (Ref. Planmeca®: J2900263-16)	<b>178<sup>00</sup>€</b>
	<b>Conexión instrumento:</b> EMS Piezon, sin luz <b>Conexión equipo:</b> Planmeca	<b>Longitud:</b> 93cm <b>Color:</b> Gris claro (RAL 9002) <b>Diámetro:</b> 9mm <b>Resistencia:</b> 1300 Ohm
	<b>Origen:</b> Italia <b>Fabricante:</b> Tekne Dental (TKD®) <b>Garantía:</b> 12 meses <b>Ref.:</b> <b>40-72K1200</b> (Ref. Planmeca®: J2900263-16)	<b>178<sup>00</sup>€</b>

BAJO PEDIDO

## Mangueras para Micromotores: Conector a Bien Air® / Open End

RUMAR



NUEVO

Conexión Abierta / Open End		Características
	<b>Conexión instrumento:</b> MC2, Isolite/LED, ISO300 con luz <b>Conexión equipo:</b> Abierta	<b>Longitud:</b> 200cm <b>Color:</b> Gris claro (RAL 9002) ** Adquiriendo casquillo Ref: 40-010 se transforma en versión s/luz = "2 EN 1"
	<b>Origen:</b> Italia <b>Fabricante:</b> Tekne Dental (TKD®) <b>Garantía:</b> 12 meses <b>Ref.:</b> <b>40-51B1006**</b>	<b>106<sup>80</sup>€</b>
	<b>Conexión instrumento:</b> MC2, Isolite/LED, ISO300 con luz <b>Conexión equipo:</b> Abierta	<b>Longitud:</b> 160cm <b>Color:</b> Gris claro (RAL 9002) ** Adquiriendo casquillo Ref: 40-010 se transforma en versión s/luz = "2 EN 1"
	<b>Origen:</b> Italia <b>Fabricante:</b> Tekne Dental (TKD®) <b>Garantía:</b> 12 meses <b>Ref.:</b> <b>40-51A1006**</b>	<b>98<sup>00</sup>€</b>
	<b>Conexión instrumento:</b> MC2, Isolite/LED, ISO300 con luz <b>Conexión equipo:</b> Abierta	<b>Longitud:</b> 200cm <b>Color:</b> Gris oscuro (RAL 7038) ** Adquiriendo casquillo Ref: 40-010 se transforma en versión s/luz = "2 EN 1"
	<b>Origen:</b> Italia <b>Fabricante:</b> Tekne Dental (TKD®) <b>Garantía:</b> 12 meses <b>Ref.:</b> <b>40-51B2006**</b>	<b>106<sup>80</sup>€</b>
	<b>Conexión instrumento:</b> MC2, Isolite/LED, ISO300 con luz <b>Conexión equipo:</b> Abierta	<b>Longitud:</b> 160cm <b>Color:</b> Gris oscuro (RAL 7038) ** Adquiriendo casquillo Ref: 40-010 se transforma en versión s/luz = "2 EN 1"
	<b>Origen:</b> Italia <b>Fabricante:</b> Tekne Dental (TKD®) <b>Garantía:</b> 12 meses <b>Ref.:</b> <b>40-51A2006**</b>	<b>98<sup>00</sup>€</b>
	<b>Conexión instrumento:</b> MC2, Isolite/LED, ISO300 con luz <b>Conexión equipo:</b> Abierta	<b>Longitud:</b> 160cm <b>Color:</b> Gris claro (RAL 9002) <b>Terminal giratorio:</b> 540° ** Adquiriendo casquillo Ref: 40-010 se transforma en versión s/luz = "2 EN 1"
	<b>Origen:</b> Italia <b>Fabricante:</b> Tekne Dental (TKD®) <b>Garantía:</b> 12 meses <b>Ref.:</b> <b>40-51A1001**</b>	<b>138<sup>80</sup>€</b>
	<b>Conexión instrumento:</b> MC2, Isolite/LED, ISO300 con luz <b>Conexión equipo:</b> Abierta	<b>Longitud:</b> 160cm <b>Color:</b> Gris oscuro (RAL 7038) <b>Terminal giratorio:</b> 540° ** Adquiriendo casquillo Ref: 40-010 se transforma en versión s/luz = "2 EN 1"
	<b>Origen:</b> Italia <b>Fabricante:</b> Tekne Dental (TKD®) <b>Garantía:</b> 12 meses <b>Ref.:</b> <b>40-51A2001**</b>	<b>138<sup>80</sup>€</b>
	<b>Conexión instrumento:</b> MC2 IR, sin luz <b>Conexión equipo:</b> Abierta	<b>Longitud:</b> 200cm <b>Color:</b> Gris claro (RAL 9002)
	<b>Origen:</b> Italia <b>Fabricante:</b> Tekne Dental (TKD®) <b>Garantía:</b> 12 meses <b>Ref.:</b> <b>40-51B1002</b>	<b>102<sup>80</sup>€</b>

BAJO PEDIDO

BAJO PEDIDO

BAJO PEDIDO











NUEVO

NUEVO



## Conexión Abierta / Open End

## Características



	<p><b>Conexión instrumento:</b> MC2 IR, sin luz</p> <p><b>Conexión equipo:</b> Abierta</p> <p><b>Origen:</b> Italia      <b>Fabricante:</b> Tekne Dental (TKD®)      <b>Garantía:</b> 12 meses</p> <p><b>Ref.:</b> <b>40-51A1002</b></p>	<p><b>Longitud:</b> 160cm</p> <p><b>Color:</b> Gris claro (RAL 9002)</p> <p><b>93'80€</b></p>	
	<p><b>Conexión instrumento:</b> MC2 IR, sin luz</p> <p><b>Conexión equipo:</b> Abierta</p> <p><b>Origen:</b> Italia      <b>Fabricante:</b> Tekne Dental (TKD®)      <b>Garantía:</b> 12 meses</p> <p><b>Ref.:</b> <b>40-51A2002</b></p>	<p><b>Longitud:</b> 160cm</p> <p><b>Color:</b> Gris oscuro (RAL 7038)</p> <p><b>93'80€</b></p>	
NUEVO		<p><b>Conexión instrumento:</b> MC3/LK/LED + turbina, Polivalente, con y sin luz</p> <p><b>Conexión equipo:</b> Abierta</p> <p><b>Origen:</b> Italia      <b>Fabricante:</b> Tekne Dental (TKD®)      <b>Garantía:</b> 12 meses</p> <p><b>Ref.:</b> <b>40-51B1003</b></p>	<p><b>Longitud:</b> 200cm</p> <p><b>Color:</b> Gris claro (RAL 9002)</p> <p><b>103'80€</b></p> <p><b>BAJO PEDIDO</b></p>
		<p><b>Conexión instrumento:</b> MC3/LK/LED + turbina, Polivalente, con y sin luz</p> <p><b>Conexión equipo:</b> Abierta</p> <p><b>Origen:</b> Italia      <b>Fabricante:</b> Tekne Dental (TKD®)      <b>Garantía:</b> 12 meses</p> <p><b>Ref.:</b> <b>40-51A1003</b></p>	<p><b>Longitud:</b> 160cm</p> <p><b>Color:</b> Gris claro (RAL 9002)</p> <p><b>94'80€</b></p>
NUEVO		<p><b>Conexión instrumento:</b> MC3/LK/LED + turbina, Polivalente, con y sin luz</p> <p><b>Conexión equipo:</b> Abierta</p> <p><b>Origen:</b> Italia      <b>Fabricante:</b> Tekne Dental (TKD®)      <b>Garantía:</b> 12 meses</p> <p><b>Ref.:</b> <b>40-51B2003</b></p>	<p><b>Longitud:</b> 200cm</p> <p><b>Color:</b> Gris oscuro (RAL 7038)</p> <p><b>103'80€</b></p> <p><b>BAJO PEDIDO</b></p>
		<p><b>Conexión instrumento:</b> MC3/LK/LED + turbina, Polivalente, con y sin luz</p> <p><b>Conexión equipo:</b> Abierta</p> <p><b>Origen:</b> Italia      <b>Fabricante:</b> Tekne Dental (TKD®)      <b>Garantía:</b> 12 meses</p> <p><b>Ref.:</b> <b>40-51A2003</b></p>	<p><b>Longitud:</b> 160cm</p> <p><b>Color:</b> Gris oscuro (RAL 7038)</p> <p><b>94'80€</b></p>
	<p><b>Conexión instrumento:</b> MC3/LK/LED, con y sin luz</p> <p><b>Conexión equipo:</b> Abierta</p> <p><b>Origen:</b> Italia      <b>Fabricante:</b> Tekne Dental (TKD®)      <b>Garantía:</b> 12 meses</p> <p><b>Ref.:</b> <b>40-51A2005</b></p>	<p><b>Longitud:</b> 160cm</p> <p><b>Color:</b> Gris oscuro (RAL 7038)</p> <p><b>87'80€</b></p>	
	<p><b>Conexión instrumento:</b> MC3/LK/LED con y sin luz</p> <p><b>Conexión equipo:</b> Abierta</p> <p><b>Origen:</b> Italia      <b>Fabricante:</b> Tekne Dental (TKD®)      <b>Garantía:</b> 12 meses</p> <p><b>Ref.:</b> <b>40-51A2004</b></p>	<p><b>Longitud:</b> 160cm</p> <p><b>Color:</b> Gris oscuro (RAL 7038)</p> <p><b>Regulación de spray</b></p> <p><b>198'00€</b></p> <p><b>BAJO PEDIDO</b></p>	
	<p><b>Conexión instrumento:</b> MCX LED</p> <p><b>Conexión equipo:</b> Abierta</p> <p><b>Origen:</b> Italia      <b>Fabricante:</b> Tekne Dental (TKD®)      <b>Garantía:</b> 12 meses</p> <p><b>Ref.:</b> <b>40-51A1007</b></p>	<p><b>Longitud:</b> 160cm</p> <p><b>Color:</b> Gris claro (RAL 9002)</p> <p><b>148'00€</b></p>	
	<p><b>Conexión instrumento:</b> MCX LED</p> <p><b>Conexión equipo:</b> Abierta</p> <p><b>Origen:</b> Italia      <b>Fabricante:</b> Tekne Dental (TKD®)      <b>Garantía:</b> 12 meses</p> <p><b>Ref.:</b> <b>40-51A2007</b></p>	<p><b>Longitud:</b> 160cm</p> <p><b>Color:</b> Gris oscuro (RAL 7038)</p> <p><b>148'00€</b></p>	

Conexión Abierta / Open End		Características
	<p><b>Conexión instrumento:</b> MCX LED <b>Conexión equipo:</b> Abierta</p> <p><b>Origen:</b> Italia      <b>Fabricante:</b> Tekne Dental (TKD®)      <b>Garantía:</b> 12 meses</p> <p><b>Ref.: 40-51A1008</b> <span style="float: right;"><b>168<sup>00</sup>€</b></span></p>	<p><b>Longitud:</b> 160cm <b>Color:</b> Gris claro (RAL 9002) <b>Terminal giratorio:</b> 540°</p> <p style="text-align: right;"><b>BAJO PEDIDO</b></p>
	<p><b>Conexión instrumento:</b> MCX LED <b>Conexión equipo:</b> Abierta</p> <p><b>Origen:</b> Italia      <b>Fabricante:</b> Tekne Dental (TKD®)      <b>Garantía:</b> 12 meses</p> <p><b>Ref.: 40-51A2008</b> <span style="float: right;"><b>168<sup>00</sup>€</b></span></p>	<p><b>Longitud:</b> 160cm <b>Color:</b> Gris oscuro (RAL 7038) <b>Terminal giratorio:</b> 540°</p> <p style="text-align: right;"><b>BAJO PEDIDO</b></p>

**Mangueras para Micromotores: Conector a Chirana® / Open End** RUMAR 







Conexión Abierta / Open End		Características
	<p><b>Conexión instrumento:</b> Micromotor Chirana® CH660 <b>Conexión equipo:</b> Abierta</p> <p><b>Origen:</b> Italia      <b>Fabricante:</b> Tekne Dental (TKD®)      <b>Garantía:</b> 12 meses</p> <p><b>Ref.: 40-51B1201</b> <span style="float: right;"><b>161<sup>80</sup>€</b></span></p>	<p><b>Longitud:</b> 200cm <b>Color:</b> Gris claro (RAL 9002)</p>

**Mangueras para Micromotores: Conector a KaVo® / Open End** RUMAR 

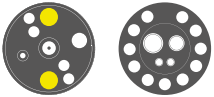
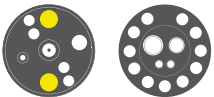
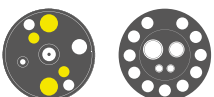
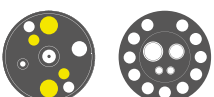
Conexión Abierta / Open End		Características
	<p><b>Conexión instrumento:</b> Micromotor KaVo® K190, K196, K197 y K200 <b>Conexión equipo:</b> Abierta</p> <p><b>Origen:</b> Italia      <b>Fabricante:</b> Tekne Dental (TKD®)      <b>Garantía:</b> 12 meses</p> <p><b>Ref.: 40-51B1201</b> <span style="float: right;"><b>161<sup>80</sup>€</b></span></p>	<p><b>Longitud:</b> 200cm <b>Color:</b> Gris claro (RAL 9002)</p>
	<p><b>Conexión instrumento:</b> Micromotor KaVo® K192 y K201 <b>Conexión equipo:</b> Abierta</p> <p><b>Garantía:</b> 6 meses</p> <p><b>Ref.: 40-51N1204</b> <span style="float: right;"><b>219<sup>80</sup>€</b></span></p>	<p><b>Longitud:</b> 190cm <b>Color:</b> Gris claro (RAL 9002)</p>
	<p><b>Conexión instrumento:</b> Micromotor KaVo® K192 y K201 <b>Conexión equipo:</b> Abierta</p> <p><b>Garantía:</b> 6 meses</p> <p><b>Ref.: 40-51N2204</b> <span style="float: right;"><b>219<sup>80</sup>€</b></span></p>	<p><b>Longitud:</b> 190cm <b>Color:</b> Gris oscuro (RAL 7038)</p>
	<p><b>Conexión instrumento:</b> KaVo® K700, KL700 y KL701 <b>Conexión equipo:</b> Abierta</p> <p><b>Garantía:</b> 6 meses</p> <p><b>Ref.: 40-51N1206</b> <span style="float: right;"><b>168<sup>00</sup>€</b></span></p>	<p><b>Longitud:</b> 190cm <b>Color:</b> Gris claro (RAL 9002)</p>
	<p><b>Conexión instrumento:</b> KaVo® K700, KL700 y KL701 <b>Conexión equipo:</b> Abierta</p> <p><b>Origen:</b> Italia      <b>Fabricante:</b> Tekne Dental (TKD®)      <b>Garantía:</b> 12 meses</p> <p><b>Ref.: 40-51B1202</b> <span style="float: right;"><b>281<sup>80</sup>€</b></span></p>	<p><b>Longitud:</b> 200cm <b>Color:</b> Gris claro (RAL 9002) <b>Regulación de spray</b></p>











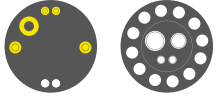







## Conector a equipo Cefla® (desde 2006), Castellini®, Anthos®, Stern Weber®

## Características

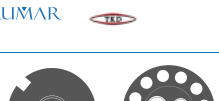
	<p><b>Conexión instrumento:</b> Bien Air® MC2 IR</p> <p><b>Conexión equipo Cefla® (desde 2006):</b> Anthos®: A3, A5, A6, A7, A9, L6, L9, R7; Stern Weber®: S200, S220TR S250, S280TRC, S300, 320TR, S320TR, S380TRC; Castellini®: SKEMA 5, SKEMA 6, SKEMA 8</p> <p><b>Origen:</b> Italia <b>Fabricante:</b> Tekne Dental (TKD®) <b>Garantía:</b> 12 meses</p> <p><b>Ref.:</b> <b>40-52E2002</b> <b>148'80€</b></p>	<p><b>Longitud:</b> 135cm <b>Color:</b> Gris oscuro (RAL 7038)</p>
	<p><b>Conexión instrumento:</b> Bien Air® MC2 IR</p> <p><b>Conexión equipo Cefla® (desde 2006):</b> Anthos®: A3, A5, A6, A7, A9, L6, L9, R7; Stern Weber®: S200, S220TR S250, S280TRC, S300, 320TR, S320TR, S380TRC; Castellini®: SKEMA 5, SKEMA 6, SKEMA 8</p> <p><b>Origen:</b> Italia <b>Fabricante:</b> Tekne Dental (TKD®) <b>Garantía:</b> 12 meses</p> <p><b>Ref.:</b> <b>40-52G2002</b> <b>158'80€</b></p>	<p><b>Longitud:</b> 120cm <b>Color:</b> Gris oscuro (RAL 7038)</p>
	<p><b>Conexión instrumento:</b> Bien Air® MC2 Isolite/LED</p> <p><b>Conexión equipo Cefla® (desde 2006):</b> Anthos®: A3, A5, A6, A7, A9, L6, L9, R7; Stern Weber®: S200, S220TR S250, S280TRC, S300, 320TR, S320TR, S380TRC; Castellini®: SKEMA 5, SKEMA 6, SKEMA 8</p> <p><b>Origen:</b> Italia <b>Fabricante:</b> Tekne Dental (TKD®) <b>Garantía:</b> 12 meses</p> <p><b>Ref.:</b> <b>40-52E2006</b> <b>174'80€</b></p>	<p><b>Longitud:</b> 135cm <b>Color:</b> Gris oscuro (RAL 7038)</p> <p style="text-align: right;"><b>BAJO PEDIDO</b></p>
	<p><b>Conexión instrumento:</b> Bien Air® MC2 Isolite/LED</p> <p><b>Conexión equipo Cefla® (desde 2006):</b> Anthos®: A3, A5, A6, A7, A9, L6, L9, R7; Stern Weber®: S200, S220TR S250, S280TRC, S300, 320TR, S320TR, S380TRC; Castellini®: SKEMA 5, SKEMA 6, SKEMA 8</p> <p><b>Origen:</b> Italia <b>Fabricante:</b> Tekne Dental (TKD®) <b>Garantía:</b> 12 meses</p> <p><b>Ref.:</b> <b>40-52G2006</b> <b>185'80€</b></p>	<p><b>Longitud:</b> 120cm <b>Color:</b> Gris oscuro (RAL 7038)</p>
	<p><b>Conexión instrumento:</b> Bien Air® MC3, MC3LK, MC3 LED, con y sin luz.</p> <p><b>Conexión equipo Cefla® (desde 2006):</b> Anthos®: A3, A5, A6, A7, A9, L6, L9, R7; Stern Weber®: S200, S220TR S250, S280TRC, S300, 320TR, S320TR, S380TRC; Castellini®: SKEMA 5, SKEMA 6, SKEMA 8</p> <p><b>Origen:</b> Italia <b>Fabricante:</b> Tekne Dental (TKD®) <b>Garantía:</b> 12 meses</p> <p><b>Ref.:</b> <b>40-52E2005</b> <b>164'80€</b></p>	<p><b>Longitud:</b> 135cm <b>Color:</b> Gris oscuro (RAL 7038)</p>
	<p><b>Conexión instrumento:</b> Bien Air® MC3, MC3LK, MC3 LED, con y sin luz.</p> <p><b>Conexión equipo Cefla® (desde 2006):</b> Anthos®: A3, A5, A6, A7, A9, L6, L9, R7; Stern Weber®: S200, S220TR S250, S280TRC, S300, 320TR, S320TR, S380TRC; Castellini®: SKEMA 5, SKEMA 6, SKEMA 8</p> <p><b>Origen:</b> Italia <b>Fabricante:</b> Tekne Dental (TKD®) <b>Garantía:</b> 12 meses</p> <p><b>Ref.:</b> <b>40-52G2005</b> <b>178'00€</b></p>	<p><b>Longitud:</b> 120cm <b>Color:</b> Gris oscuro (RAL 7038)</p>
	<p><b>Conexión instrumento:</b> Bien Air® MC3, MC3LK, MC3 LED, con y sin luz.</p> <p><b>Conexión equipo Cefla® (desde 2006):</b> Anthos®: A3, A5, A6, A7, A9, L6, L9, R7; Stern Weber®: S200, S220TR S250, S280TRC, S300, 320TR, S320TR, S380TRC; Castellini®: SKEMA 5, SKEMA 6, SKEMA 8</p> <p><b>Origen:</b> Italia <b>Fabricante:</b> Tekne Dental (TKD®) <b>Garantía:</b> 12 meses</p> <p><b>Ref.:</b> <b>40-52E2004</b> <b>184'80€</b></p>	<p><b>Longitud:</b> 135cm <b>Color:</b> Gris oscuro (RAL 7038) <b>Terminal giratorio</b></p>
	<p><b>Conexión instrumento:</b> Bien Air® MC3, MC3LK, MC3 LED, con y sin luz.</p> <p><b>Conexión equipo Cefla® (desde 2006):</b> Anthos®: A3, A5, A6, A7, A9, L6, L9, R7; Stern Weber®: S200, S220TR S250, S280TRC, S300, 320TR, S320TR, S380TRC; Castellini®: SKEMA 5, SKEMA 6, SKEMA 8</p> <p><b>Origen:</b> Italia <b>Fabricante:</b> Tekne Dental (TKD®) <b>Garantía:</b> 12 meses</p> <p><b>Ref.:</b> <b>40-52G2004</b> <b>196'80€</b></p>	<p><b>Longitud:</b> 120cm <b>Color:</b> Gris oscuro (RAL 7038) <b>Terminal giratorio</b></p>
	<p><b>Conexión instrumento:</b> Bien Air® MC3/LK/LED + turbina, polivalente con y sin luz</p> <p><b>Conexión equipo Cefla® (desde 2006):</b> Anthos®: A3, A5, A6, A7, A9, L6, L9, R7; Stern Weber®: S200, S220TR S250, S280TRC, S300, 320TR, S320TR, S380TRC; Castellini®: SKEMA 5, SKEMA 6, SKEMA 8</p> <p><b>Origen:</b> Italia <b>Fabricante:</b> Tekne Dental (TKD®) <b>Garantía:</b> 12 meses</p> <p><b>Ref.:</b> <b>40-52E2003</b> <b>184'80€</b></p>	<p><b>Longitud:</b> 135cm <b>Color:</b> Gris oscuro (RAL 7038)</p> <p style="text-align: right;"><b>BAJO PEDIDO</b></p>
	<p><b>Conexión instrumento:</b> Bien Air® MC3/LK/LED + turbina, polivalente con y sin luz</p> <p><b>Conexión equipo Cefla® (desde 2006):</b> Anthos®: A3, A5, A6, A7, A9, L6, L9, R7; Stern Weber®: S200, S220TR S250, S280TRC, S300, 320TR, S320TR, S380TRC; Castellini®: SKEMA 5, SKEMA 6, SKEMA 8</p> <p><b>Origen:</b> Italia <b>Fabricante:</b> Tekne Dental (TKD®) <b>Garantía:</b> 12 meses</p> <p><b>Ref.:</b> <b>40-52G2003</b> <b>196'80€</b></p>	<p><b>Longitud:</b> 120cm <b>Color:</b> Gris oscuro (RAL 7038)</p>

























**Conector a equipo KaVo®**

**Características**

 RUMAR	<p><b>Conexión instrumento:</b> KaVo® K192 y K201  <b>Conexión equipo:</b> KaVo® 1057 y 1060</p> <p><b>Garantía:</b> 6 meses</p> <p><b>Ref.: 40-52M1205</b></p>	<p><b>Longitud:</b> 135cm  <b>Color:</b> Gris claro (RAL 9002)  <b>Regulación de spray</b></p> <p><b>254<sup>80</sup>€</b></p>
 RUMAR	<p><b>Conexión instrumento:</b> KaVo® K192 y K201  <b>Conexión equipo:</b> KaVo® 1058, 1063, 1065, 1078 y 1080</p> <p><b>Garantía:</b> 6 meses</p> <p><b>Ref.: 40-52M1206</b></p>	<p><b>Longitud:</b> 135cm  <b>Color:</b> Gris claro (RAL 9002)  <b>Terminal giratorio</b>  <b>Regulación de spray</b></p> <p><b>254<sup>80</sup>€</b></p>
 RUMAR 	<p><b>Conexión instrumento:</b> KaVo® K190, K196 y K200  <b>Conexión equipo:</b> KaVo® 1057 y 1060</p> <p><b>Origen:</b> Italia      <b>Fabricante:</b> Tekne Dental (TKD®)      <b>Garantía:</b> 12 meses</p> <p><b>Ref.: 40-52G6201</b></p>	<p><b>Longitud:</b> 120cm  <b>Color:</b> Gris medio (RAL 7035)  <b>Terminal giratorio</b></p> <p><b>218<sup>00</sup>€</b></p>
 RUMAR 	<p><b>Conexión instrumento:</b> Micromotor KaVo® K190, K196 y K200  <b>Conexión equipo:</b> KaVo® 1057 y 1060</p> <p><b>Origen:</b> Italia      <b>Fabricante:</b> Tekne Dental (TKD®)      <b>Garantía:</b> 12 meses</p> <p><b>Ref.: 40-52E6201</b></p>	<p><b>Longitud:</b> 135cm  <b>Color:</b> Gris claro (RAL 7035)  <b>Terminal giratorio</b></p> <p><b>218<sup>00</sup>€</b></p>
 RUMAR 	<p><b>Conexión instrumento:</b> Micromotor KaVo® K190, K196 y K200  <b>Conexión equipo:</b> KaVo® 1057 y 1060</p> <p><b>Origen:</b> Italia      <b>Fabricante:</b> Tekne Dental (TKD®)      <b>Garantía:</b> 12 meses</p> <p><b>Ref.: 40-52G6211</b></p>	<p><b>Longitud:</b> 120cm  <b>Color:</b> Gris medio (RAL 7035)  <b>Terminal giratorio</b>  <b>Regulación de spray</b></p> <p><b>318<sup>00</sup>€</b></p> <p style="text-align: right;"><b>BAJO PEDIDO</b></p>
 RUMAR 	<p><b>Conexión instrumento:</b> KaVo® K190, K196 y K200  <b>Conexión equipo:</b> KaVo® 1057 y 1060</p> <p><b>Origen:</b> Italia      <b>Fabricante:</b> Tekne Dental (TKD®)      <b>Garantía:</b> 12 meses</p> <p><b>Ref.: 40-52E6211</b></p>	<p><b>Longitud:</b> 135cm  <b>Color:</b> Gris medio (RAL 7035)  <b>Terminal giratorio</b>  <b>Regulación de spray</b></p> <p><b>324<sup>80</sup>€</b></p> <p style="text-align: right;"><b>BAJO PEDIDO</b></p>
 RUMAR 	<p><b>Conexión instrumento:</b> KaVo® K190, K196 y K200  <b>Conexión equipo:</b> KaVo® 1058*, 1062, 1063, 1065, 1066, 1078 y 1080 (Serie 1), (*Excepto 1058TM Primus Life)</p> <p><b>Origen:</b> Italia      <b>Fabricante:</b> Tekne Dental (TKD®)      <b>Garantía:</b> 12 meses</p> <p><b>Ref.: 40-52G6221</b></p>	<p><b>Longitud:</b> 120cm  <b>Color:</b> Gris medio (RAL 7035)  <b>Terminal giratorio</b></p> <p><b>208<sup>00</sup>€</b></p> <p style="text-align: right;"><b>BAJO PEDIDO</b></p>
 RUMAR 	<p><b>Conexión instrumento:</b> KaVo® K190, K196 y K200  <b>Conexión equipo:</b> KaVo® 1058*, 1062, 1063, 1065, 1066, 1078 y 1080 (Serie 1), (*Excepto 1058TM Primus Life)</p> <p><b>Origen:</b> Italia      <b>Fabricante:</b> Tekne Dental (TKD®)      <b>Garantía:</b> 12 meses</p> <p><b>Ref.: 40-52E6221</b></p>	<p><b>Longitud:</b> 135cm  <b>Color:</b> Gris medio (RAL 7035)  <b>Terminal giratorio</b></p> <p><b>214<sup>80</sup>€</b></p>
 RUMAR 	<p><b>Conexión instrumento:</b> KaVo® K190, K196 y K200  <b>Conexión equipo:</b> KaVo® 1058*, 1062, 1063, 1065, 1066, 1078 y 1080 (Serie 1), (*Excepto 1058TM Primus Life)</p> <p><b>Origen:</b> Italia      <b>Fabricante:</b> Tekne Dental (TKD®)      <b>Garantía:</b> 12 meses</p> <p><b>Ref.: 40-52G6231</b></p>	<p><b>Longitud:</b> 120cm  <b>Color:</b> Gris medio (RAL 7035)  <b>Terminal giratorio</b>  <b>Regulación de spray</b></p> <p><b>350<sup>80</sup>€</b></p> <p style="text-align: right;"><b>BAJO PEDIDO</b></p>
 RUMAR 	<p><b>Conexión instrumento:</b> KaVo® K190, K196 y K200  <b>Conexión equipo:</b> KaVo® 1058*, 1062, 1063, 1065, 1066, 1078 y 1080 (Serie 1), (*Excepto 1058TM Primus Life)</p> <p><b>Origen:</b> Italia      <b>Fabricante:</b> Tekne Dental (TKD®)      <b>Garantía:</b> 12 meses</p> <p><b>Ref.: 40-52E6231</b></p>	<p><b>Longitud:</b> 135cm  <b>Color:</b> Gris medio (RAL 7035)  <b>Terminal giratorio</b>  <b>Regulación de spray</b></p> <p><b>350<sup>80</sup>€</b></p> <p style="text-align: right;"><b>BAJO PEDIDO</b></p>

**Conector a equipo KaVo®**

**Características**

  <p>RUMAR </p>	<p><b>Conexión instrumento:</b> KaVo® K700, KL700 y KL701  <b>Conexión equipo:</b> KaVo® 1058*, 1062, 1063, 1065, 1066, 1078 y 1080 (Serie 1), (*Excepto 1058TM Primus Life)</p> <p><b>Origen:</b> Italia      <b>Fabricante:</b> Tekne Dental (TKD®)      <b>Garantía:</b> 12 meses</p> <p><b>Ref.:</b> <b>40-52G6300</b></p>	<p><b>Longitud:</b> 120cm  <b>Color:</b> Gris medio (RAL 7035)</p> <p style="text-align: right;"><b>211<sup>80</sup>€</b></p> <p style="text-align: right;"><b>BAJO PEDIDO</b></p>
  <p>RUMAR </p>	<p><b>Conexión instrumento:</b> KaVo® K700, KL700 y KL701  <b>Conexión equipo:</b> KaVo® 1058*, 1062, 1063, 1065, 1066, 1078 y 1080 (Serie 1), (*Excepto 1058TM Primus Life)</p> <p><b>Origen:</b> Italia      <b>Fabricante:</b> Tekne Dental (TKD®)      <b>Garantía:</b> 12 meses</p> <p><b>Ref.:</b> <b>40-52E6300</b></p>	<p><b>Longitud:</b> 135cm  <b>Color:</b> Gris medio (RAL 7035)</p> <p style="text-align: right;"><b>216<sup>80</sup>€</b></p>
  <p>RUMAR </p>	<p><b>Conexión instrumento:</b> KaVo® K700, KL700 y KL701  <b>Conexión equipo:</b> KaVo® 1058*, 1062, 1063, 1065, 1066, 1078 y 1080 (Serie 1), (*Excepto 1058TM Primus Life)</p> <p><b>Origen:</b> Italia      <b>Fabricante:</b> Tekne Dental (TKD®)      <b>Garantía:</b> 12 meses</p> <p><b>Ref.:</b> <b>40-52G6301</b></p>	<p><b>Longitud:</b> 120cm  <b>Color:</b> Gris medio (RAL 7035)  <b>Regulación de spray</b></p> <p style="text-align: right;"><b>375<sup>80</sup>€</b></p> <p style="text-align: right;"><b>BAJO PEDIDO</b></p>
  <p>RUMAR </p>	<p><b>Conexión instrumento:</b> KaVo® K700, KL700 y KL701  <b>Conexión equipo:</b> KaVo® 1058*, 1062, 1063, 1065, 1066, 1078 y 1080 (Serie 1), (*Excepto 1058TM Primus Life)</p> <p><b>Origen:</b> Italia      <b>Fabricante:</b> Tekne Dental (TKD®)      <b>Garantía:</b> 12 meses</p> <p><b>Ref.:</b> <b>40-52E6301</b></p>	<p><b>Longitud:</b> 135cm  <b>Color:</b> Gris medio (RAL 7035)  <b>Regulación de spray</b></p> <p style="text-align: right;"><b>381<sup>80</sup>€</b></p> <p style="text-align: right;"><b>BAJO PEDIDO</b></p>
  <p>RUMAR </p>	<p><b>Conexión instrumento:</b> KaVo® K700, KL700 y KL701  <b>Conexión equipo:</b> KaVo® E30, E50, E70, E80 y 1058 Primus Life (Serie 2)</p> <p><b>Origen:</b> Italia      <b>Fabricante:</b> Tekne Dental (TKD®)      <b>Garantía:</b> 12 meses</p> <p><b>Ref.:</b> <b>40-52G6310</b></p>	<p><b>Longitud:</b> 120cm  <b>Color:</b> Gris medio (RAL 7035)</p> <p style="text-align: right;"><b>222<sup>80</sup>€</b></p> <p style="text-align: right;"><b>BAJO PEDIDO</b></p>
  <p>RUMAR </p>	<p><b>Conexión instrumento:</b> KaVo® K700, KL700 y KL701  <b>Conexión equipo:</b> KaVo® E30, E50, E70, E80 y 1058 Primus Life (Serie 2)</p> <p><b>Origen:</b> Italia      <b>Fabricante:</b> Tekne Dental (TKD®)      <b>Garantía:</b> 12 meses</p> <p><b>Ref.:</b> <b>40-52E6310</b></p>	<p><b>Longitud:</b> 135cm  <b>Color:</b> Gris medio (RAL 7035)</p> <p style="text-align: right;"><b>228<sup>00</sup>€</b></p> <p style="text-align: right;"><b>BAJO PEDIDO</b></p>
  <p>RUMAR </p>	<p><b>Conexión instrumento:</b> KaVo® K700, KL700 y KL701  <b>Conexión equipo:</b> KaVo® E30, E50, E70, E80 y 1058 Primus Life (Serie 2)</p> <p><b>Origen:</b> Italia      <b>Fabricante:</b> Tekne Dental (TKD®)      <b>Garantía:</b> 12 meses</p> <p><b>Ref.:</b> <b>40-52G6311</b></p>	<p><b>Longitud:</b> 120cm  <b>Color:</b> Gris medio (RAL 7035)  <b>Regulación de spray</b></p> <p style="text-align: right;"><b>386<sup>80</sup>€</b></p> <p style="text-align: right;"><b>BAJO PEDIDO</b></p>
  <p>RUMAR </p>	<p><b>Conexión instrumento:</b> KaVo® K700, KL700 y KL701  <b>Conexión equipo:</b> KaVo® E30, E50, E70, E80 y 1058 Primus Life (Serie 2)</p> <p><b>Origen:</b> Italia      <b>Fabricante:</b> Tekne Dental (TKD®)      <b>Garantía:</b> 12 meses</p> <p><b>Ref.:</b> <b>40-52E6311</b></p>	<p><b>Longitud:</b> 135cm  <b>Color:</b> Gris medio (RAL 7035)  <b>Regulación de spray</b></p> <p style="text-align: right;"><b>392<sup>80</sup>€</b></p>

Mangueras para Micromotores: **Conector a equipos Sirona®**

RUMAR





**Conector a equipos Sirona®****Características**

	<p><b>Conexión instrumento:</b> Bien Air® MC2 e Isolite 300, con luz <b>Conexión equipo:</b> A1, A2, A4, A5, AC, C1, C1+, C2, C2+, C4.</p> <p><b>Origen:</b> Italia      <b>Fabricante:</b> Tekne Dental (TKD®)      <b>Garantía:</b> 12 meses</p> <p><b>Ref.:</b> <b>40-52L1006</b>      <b>258<sup>00</sup>€</b></p>	<p><b>Longitud:</b> 137cm <b>Color:</b> Gris claro (RAL 9002)</p> <p><b>BAJO PEDIDO</b></p>
	<p><b>Conexión instrumento:</b> Bien Air® MC3 <b>Conexión equipo:</b> A1, A2, A4, A5, AC, C1, C1+, C2, C2+, C4, C4+, C5+, C8, C8+, E1, E2, E4, EC, M1, M1+, PROFEEL, SPIRIT, S1, S2.</p> <p><b>Origen:</b> Italia      <b>Fabricante:</b> Tekne Dental (TKD®)      <b>Garantía:</b> 12 meses</p> <p><b>Ref.:</b> <b>40-52L1008</b>      <b>318<sup>00</sup>€</b></p>	<p><b>Longitud:</b> 137cm <b>Color:</b> Gris claro (RAL 9002) <b>Regulación de spray</b></p>
	<p><b>Conexión instrumento:</b> Bien Air® MC3 y NSK® TI-MAX M40 <b>Conexión equipo:</b> M1, C6 y E3, M1+, M196, C3, C3+.</p> <p><b>Origen:</b> Italia      <b>Fabricante:</b> Tekne Dental (TKD®)      <b>Garantía:</b> 12 meses</p> <p><b>Ref.:</b> <b>40-52L1005</b>      <b>268<sup>00</sup>€</b></p>	<p><b>Longitud:</b> 137cm <b>Color:</b> Gris claro (RAL 9002) <b>Terminal giratorio:</b> 400°</p>

Mangueras para Micromotores: **Conector a equipo Planmeca®**

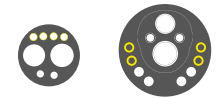
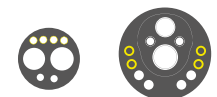
RUMAR

**Conector a equipo Planmeca®****Características**

	<p><b>Conexión instrumento:</b> Bien Air® MC3 <b>Conexión equipo:</b> Planmeca®</p> <p><b>Origen:</b> Italia      <b>Fabricante:</b> Tekne Dental (TKD®)      <b>Garantía:</b> 12 meses</p> <p><b>Ref.:</b> <b>40-52M1007</b> (Ref. Planmeca®: J10044908-1)      <b>258<sup>00</sup>€</b></p>	<p><b>Longitud:</b> 100cm <b>Color:</b> Gris claro (RAL9002) <b>Terminal giratorio:</b> 400° <b>Resistencia:</b> 82 Ohm</p>
	<p><b>Conexión instrumento:</b> Polivalente Bien Air® MC3 + Turbina, <b>Polivalente</b> <b>Conexión equipo:</b> Planmeca®</p> <p><b>Origen:</b> Italia      <b>Fabricante:</b> Tekne Dental (TKD®)      <b>Garantía:</b> 12 meses</p> <p><b>Ref.:</b> <b>40-52M1003</b> (Ref. Planmeca®: J10044909-1)      <b>282<sup>80</sup>€</b></p>	<p><b>Longitud:</b> 98cm <b>Color:</b> Gris claro (RAL9002) <b>Resistencia:</b> 82 Ohm</p> <p><b>BAJO PEDIDO</b></p>
	<p><b>Conexión instrumento:</b> Polivalente Bien Air® MC3 + Turbina, <b>Polivalente</b> <b>Conexión equipo:</b> Planmeca®</p> <p><b>Origen:</b> Italia      <b>Fabricante:</b> Tekne Dental (TKD®)      <b>Garantía:</b> 12 meses</p> <p><b>Ref.:</b> <b>40-52K1003</b>      <b>282<sup>80</sup>€</b></p>	<p><b>Longitud:</b> 90cm <b>Color:</b> Gris claro (RAL 9002) <b>Resistencia:</b> 82 Ohm</p> <p><b>BAJO PEDIDO</b></p>
	<p><b>Conexión instrumento:</b> KaVo® K190, K196 y K200 y Chirana® Medical CH660, con luz <b>Conexión equipo:</b> Planmeca®</p> <p><b>Origen:</b> Italia      <b>Fabricante:</b> Tekne Dental (TKD®)      <b>Garantía:</b> 12 meses</p> <p><b>Ref.:</b> <b>40-52M1201</b> (Ref. Planmeca®: J10007954-4)      <b>198<sup>00</sup>€</b></p>	<p><b>Longitud:</b> 100cm <b>Color:</b> Gris claro (RAL 9002) <b>Resistencia:</b> 270 Ohm</p>
	<p><b>Conexión instrumento:</b> KaVo® K190, K196 y K200, con luz <b>Conexión equipo:</b> Planmeca®</p> <p><b>Origen:</b> Italia      <b>Fabricante:</b> Tekne Dental (TKD®)      <b>Garantía:</b> 12 meses</p> <p><b>Ref.:</b> <b>40-52M1204</b> (Ref. Planmeca®: J10007954-4)      <b>268<sup>00</sup>€</b></p>	<p><b>Longitud:</b> 101cm <b>Color:</b> Gris claro (RAL 9002) <b>Terminal giratorio:</b> 400° <b>Resistencia:</b> 270 Ohm</p> <p><b>BAJO PEDIDO</b></p>
	<p><b>Conexión instrumento:</b> KaVo® K190, K196 y K200, con luz <b>Conexión equipo:</b> Planmeca®</p> <p><b>Garantía:</b> 6 meses</p> <p><b>Ref.:</b> <b>40-52M1203</b>      <b>282<sup>80</sup>€</b></p>	<p><b>Longitud:</b> 101cm <b>Color:</b> Gris claro (RAL 9002) <b>Terminal giratorio:</b> 400° <b>Resistencia:</b> 270 Ohm <b>(Especial Kart)</b></p> <p><b>HASTA AGOTAR</b></p>

**Conector a equipo Planmeca®**

**Características**

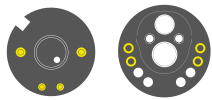

**Conexión instrumento:** KaVo® K190, K196 y K200, con luz

**Conexión equipo:** Planmeca®

**Garantía:** 6 meses

**Ref.:** 40-52M1202 (Ref. Planmeca®: 5180.982.00)

**282<sup>80</sup>€**

**Longitud:** 100cm  
**Color:** Gris claro (RAL 9002)  
**Terminal giratorio:** 400°  
**Resistencia:** 270 Ohm

**PARA EQUIPOS SWIDENT® U OMS® CONTACTE CON NOSOTROS**

**Accesorios y conectores para mangueras**

RUMAR



**Descripción**

**Características**



Casquillo metálico adaptador para mangueras MC2

**Ref.:** 40-010

**12<sup>80</sup>€**



Casquillo metálico adaptador para convertir mangueras MC3 a turbina

**Ref.:** 40-006

**15<sup>80</sup>€**



Kit conector manguera a unidades KaVo® (Serie 1)

**Ref.:** 40-020

**53<sup>80</sup>€**

**Mangueras para Jeringa**

**Descripción**

**Características**



**Conexión instrumento:** Manguera para jeringa, sin luz

**Conexión equipo:** Abierta

**Origen:** Italia

**Fabricante:** Tekne Dental (TKD®)

**Garantía:** 12 meses

**Ref.:** 40-61A2000

**38<sup>00</sup>€**

**Longitud:** 160cm  
**Color:** Gris oscuro (RAL 7038)

RUMAR



**Mangueras para lámparas fotocurado**

RUMAR



**Conexión Abierta / Open End**

**Características**



**Conexión instrumento:** Lámpara TKD® Moon, compatible lámpara Castellini T-LED

**Conexión equipo:** Abierta

**Origen:** Italia

**Fabricante:** Tekne Dental (TKD®)

**Garantía:** 12 meses

**Ref.:** 40-91A2000

**52<sup>80</sup>€**

**Longitud:** 160cm  
**Color:** Gris oscuro (RAL 7038)

## Mangueras para pedales

RUMAR

## Descripción



Manguera para pedales con control de agua y sin chip blower, 3 vías.

Sin conectores

Funda de silicona

Origen: Italia

Fabricante: Tekne Dental (TKD®)

Garantía: 12 meses

Ref.: 37-241

50<sup>80</sup>€

HASTA AGOTAR

## Características

Longitud: 180cm

Color: Gris claro (RAL 9002)

Color: Gris oscuro (RAL 7035+)

Aséptico

**NO ADMITEN DEVOLUCIÓN**

Venta en múltiplos de 1 metro



Manguera para pedales con control de agua y chip blower, 4 tubos paralelos.

Sin conectores

Ref.: 44-850

14<sup>80</sup>€/metro



## RV ▶ REPUESTOS VARIOS







- Repuestos Micron® scaler SSS
- Repuestos pulidor bicarbonato Micron® Quick Jet
- Repuestos lámparas quirófano Derungs®
- Repuestos Nouvag®
- Repuestos Woodpecker® y DTE®
- Repuestos lámparas fotocurado

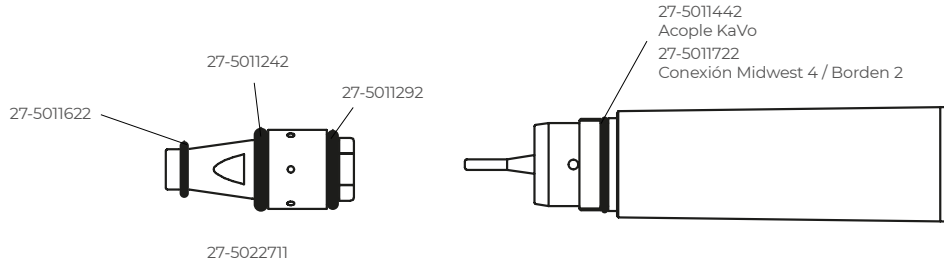

# REPUESTOS ULTRASONIDOS MICRON® SSS



Ultrasonidos Micron® SSS









	Descripción	Observaciones
 <p><b>Ref.: 27-5022711</b></p>	<p>Cartucho cuerpo de oscilación</p> <p><b>348<sup>00</sup>€</b></p>	
 <p><b>Ref.: 27-5011622</b></p>	<p>Anillo tórico</p> <p><b>3<sup>80</sup>€</b></p>	
 <p><b>Ref.: 27-5011242</b></p>	<p>Anillo tórico</p> <p><b>3<sup>80</sup>€</b></p>	
 <p><b>Ref.: 27-5011292</b></p>	<p>Anillo tórico</p> <p><b>3<sup>80</sup>€</b></p>	
 <p><b>Ref.: 27-5011442</b></p>	<p>Anillo tórico (SSS acople KaVo®)</p> <p><b>3<sup>80</sup>€</b></p>	
 <p><b>Ref.: 27-5011722</b></p>	<p>Anillo tórico (SSS conexión Midwest 4 / Borden 2)</p> <p><b>3<sup>80</sup>€</b></p>	

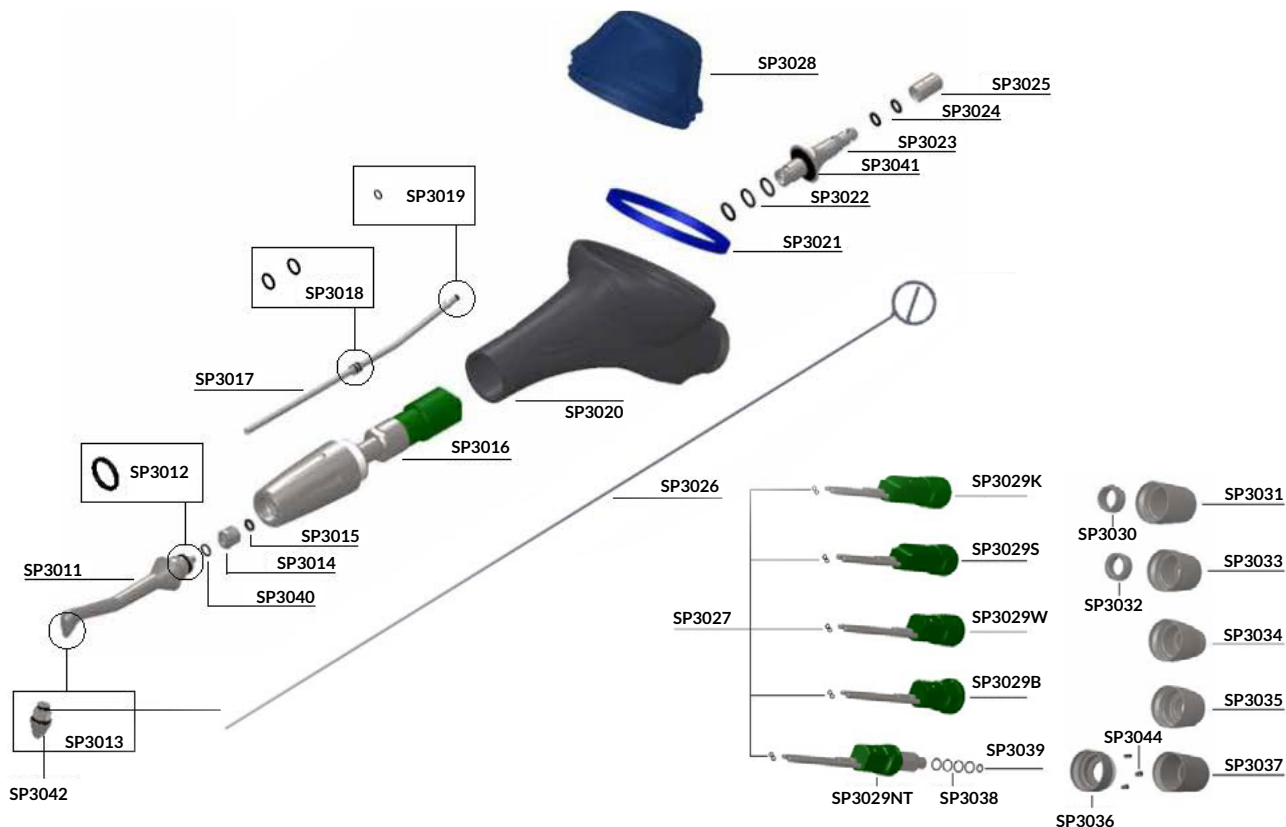



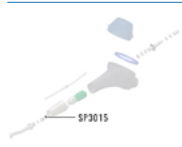



Las PUNTAS y LLAVES se consideran accesorios y se encuentran en el catálogo de APARATOLOGÍA

## Pulidor bicarbonato ECO PULIMAX

	Descripción	Observaciones
	Punta pulidor ECO PULIMAX  <b>Ref.: 44-231</b>	<b>19<sup>80</sup>€</b>
	Kit 2 anillos tóricos conexión punta pulidor ECO PULIMAX  <b>Ref.: OR-232</b>	<b>1<sup>50</sup>€</b>



	Descripción	Observaciones
	Anillo tórico  <b>Ref.: OR-SP3012</b>	2'80.€
	Anillo tórico  <b>Ref.: OR-SP3015</b>	3'00.€
	Anillo tórico  <b>Ref.: OR-SP3018</b>	2'80.€
	Anillo tórico  <b>Ref.: OR-SP3019</b>	2'80.€
	Junta sellado depósito bicarbonato  <b>Ref.: OR-SP3021</b>	10'80.€

	Descripción	Observaciones
	<p>Anillo tórico</p> <p>Ref.: <b>OR-SP3022</b></p>	<p>2'80€</p>
	<p>Anillo tórico</p> <p>Ref.: <b>OR-SP3024</b></p>	<p>2'80€</p>
	<p>Anillo tórico</p> <p>Ref.: <b>OR-SP3027</b></p>	<p>2'80€</p>
	<p>Anillo tórico</p> <p>Ref.: <b>OR-SP3040</b></p>	<p>3'00€</p>
	<p>Anillo tórico</p> <p>Ref.: <b>OR-SP3041</b></p>	<p>3'00€</p>
	<p>Anillo tórico</p> <p>Ref.: <b>OR-SP3042</b></p>	<p>3'00€</p>
	<p>Alambre de desatasco</p> <p>Ref.: <b>HE-3026</b></p>	<p>7'00€</p>
	<p>Punta</p> <p>Ref.: <b>APX-SP3011</b></p>	<p>178'00€</p>

## Scaler ECO S2



RUMAR

	Descripción	Observaciones
	<p>Cuerpo vibrador</p> <p>Ref.: SCX-ECOS2CV</p>	<p>Incluye: Anillos tóricos</p> <p>128<sup>00</sup>€</p>

## REPUESTOS LÁMPARAS DE QUIRÓFANO DERUNGS®

## Modelo Xerus

Derungs 

	Descripción	Observaciones
	<p>Asa central D99205000</p> <p>Ref.: 09-910</p>	<p>69<sup>30</sup>€</p>
	<p>Pantalla D99278000</p> <p>Ref.: 09-916</p>	<p>141<sup>60</sup>€</p>

# REPUESTOS NOUVAG®

Implantología / Cirugía









NOUVAG+

	Descripción	Observaciones
 <p data-bbox="359 400 600 421">Micromotor 31-ESS para MD20</p> <p data-bbox="373 524 528 546">Ref.: 48-2064</p> <p data-bbox="1043 524 1166 555">1.168<sup>00</sup>€</p>		<p data-bbox="1193 400 1310 421">Con cable: 3m</p>
 <p data-bbox="359 598 596 618">Micromotor 31-ESS para MD10</p> <p data-bbox="373 719 528 741">Ref.: 48-2063</p> <p data-bbox="1043 719 1166 750">1.168<sup>00</sup>€</p>		<p data-bbox="1193 598 1310 618">Con cable: 2m</p>
 <p data-bbox="359 786 616 806">Micromotor 21 para MD30 / MD11</p> <p data-bbox="373 907 528 929">Ref.: 48-2097</p> <p data-bbox="1043 907 1166 938">1.108<sup>00</sup>€</p>		<p data-bbox="1193 786 1310 806">Con cable: 2m</p>
 <p data-bbox="359 974 863 994">Varilla soporte suero motores Nouvag® MD10, MD11, MD20, MD30</p> <p data-bbox="373 1095 523 1117">Ref.: 48-1770</p> <p data-bbox="1070 1095 1166 1126">34<sup>80</sup>€</p>		











# REPUESTOS WOODPECKER® Y DTE®







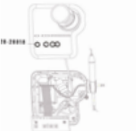



## Repuestos Ultrasonidos























	Descripción	Observaciones
	Placa electrónica Kit <b>UDS-N3</b> y <b>UDS-N3 LED</b>  <b>Ref.: 28-PCB005</b>	<b>112<sup>80</sup>€</b>
	Placa electrónica Kit <b>DTE-V3</b> y <b>DTE-V3 LED</b>  <b>Ref.: 28-PCB001</b>	<b>112<sup>80</sup>€</b>
	Válvula solenoide ultrasonidos Woodpecker® <b>UDS-E</b> y DTE® <b>D5</b> y compatibles  <b>Ref.: 28-U013</b>	<b>28<sup>80</sup>€</b>
	Válvula solenoide ultrasonidos Woodpecker® <b>U6</b> y DTE® <b>S6</b>  <b>Ref.: 28-U043</b>	<b>28<sup>80</sup>€</b>
	Fusible ultrasonidos Woodpecker® <b>UDS-E</b> , DTE® <b>D3, D5</b> y <b>D7</b> y compatibles  <b>Ref.: 28-U014</b>	<b>12<sup>80</sup>€</b>  Voltaje: 250V Tensión: 5K Amperaje: 0,5A
	Tubo gris ultrasonidos Woodpecker® <b>UDS-E</b> ; DTE® <b>D5</b> y <b>D7</b> y compatibles  <b>Ref.: 28-U015</b>	<b>12<sup>80</sup>€</b>
	Transformador ultrasonidos Woodpecker® <b>UDS-E</b> y <b>U6</b> ; DTE® <b>D5, D7</b> y <b>S6</b> y compatibles  <b>Ref.: 28-TRA005</b>	<b>38<sup>00</sup>€</b>
	Pedal ultrasonidos Woodpecker® <b>UDS-E</b> y <b>U6</b> ; DTE® <b>D5, D7, S6</b> y <b>D600</b> y compatibles  <b>Ref.: 28-U016</b>	<b>30<sup>80</sup>€</b>
	Botella con tapa 500ml DTE® <b>D7</b> y Woodpecker® <b>UDS-E</b>  <b>Ref.: 28-U017</b>	<b>13<sup>80</sup>€</b>























	Descripción	Observaciones
	<p>Conector espigas entrada ultrasonidos DTE® D7</p> <p><b>Ref.: 28-U018</b></p> <p><b>11'80€</b></p>	
	<p>Conectores receptor hembra botella ultrasonidos Woodpecker® UDS-E y DTE® D7</p> <p><b>Ref.: 28-U019</b></p> <p><b>10'80€</b></p>	
	<p>Potenciómetro regulación caudal ultrasonidos Woodpecker® UDS-E y DTE® D7 y compatibles</p> <p><b>Ref.: 28-U020</b></p> <p><b>10'80€</b></p>	
	<p>Regulador caudal ultrasonidos Woodpecker® y DTE® D5 y compatibles</p> <p><b>Ref.: 28-U030</b></p> <p><b>13'80€</b></p>	
	<p>Soporte pieza de mano ultrasonidos Woodpecker® UDS-E y DTE® D7, D5, D3 y compatibles</p> <p><b>Ref.: 28-U022</b></p> <p><b>12'80€</b></p>	
	<p>Conexión entrada agua ultrasonidos Woodpecker® y DTE® D5 y compatibles</p> <p><b>Ref.: 28-U023</b></p> <p><b>2'80€</b></p>	
	<p>Anillo tórico conexión botella suministro agua ultrasonidos Woodpecker® UDS-E y DTE® D7</p> <p><b>Ref.: 28-U027</b></p> <p><b>0'90€</b></p>	
	<p>Placa electrónica central ultrasonidos DTE® D7</p> <p><b>Ref.: 28-PCB002</b></p> <p><b>118'00€</b></p>	
	<p>Panel botonera ultrasonidos DTE® D7</p> <p><b>Ref.: 28-U028</b></p> <p><b>50'80€</b></p>	
	<p>Manguera ultrasonidos UDS-E, UDS-P, UDS-A, UDS-K y UDS-N3</p> <p><b>Ref.: 28-U007</b></p> <p><b>39'80€</b></p>	<p><b>Longitud:</b> 200cm  <b>Color:</b> Gris claro (RAL 9002)  <b>Diámetro:</b> 7mm (FINA)</p>







	Descripción	Observaciones
	Manguera ultrasonidos <b>U600 LED, U6 LED, UDS-E LED, UDS-P LED, UDS-A LED, UDS-K LED y UDS-N3 LED</b>  <b>Ref.: 28-U010</b>	Longitud: 200cm Color: Gris claro (RAL 9002) Diámetro: 7mm (FINA)  <b>50<sup>80</sup>€</b>
	Manguera ultrasonidos <b>D3, D5, D7 y V3</b>  <b>Ref.: 28-U008</b>	Longitud: 200cm Color: Gris claro (RAL 9002) Diámetro: 7mm (FINA)  <b>39<sup>80</sup>€</b>
	Manguera ultrasonidos <b>D3 LED, D5 LED, D7 LED y V3 LED</b>  <b>Ref.: 28-U009</b>	Longitud: 200cm Color: Gris claro (RAL 9002) Diámetro: 7mm (FINA)  <b>50<sup>80</sup>€</b>
 Imagen no disponible	Manguera ultrasonidos <b>U600 y U6</b>  <b>Ref.: 28-U046</b>	Longitud: 200cm Color: Gris claro (RAL 9002) Diámetro: 7mm  <b>50<sup>80</sup>€</b>
	Manguera ultrasonidos DTE <b>D600 LED y S6 LED</b>  <b>Ref.: 28-U044</b>	Longitud: 200cm Color: Gris claro (RAL 9002) Diámetro: 7mm  <b>50<sup>80</sup>€</b>
	Potenciometro regulación caudal ultrasonidos para <b>suministro interno</b> Woodpecker® <b>U600 y DTE® D600</b>  <b>Ref.: 28-U021</b>	<b>13<sup>80</sup>€</b>
	Regulador caudal ultrasonidos para <b>suministro externo</b> Woodpecker® <b>U6 y U600, DTE® S6 y D600</b>  <b>Ref.: 28-U031</b>	<b>13<sup>80</sup>€</b>
	Tanque con tapa ultrasonidos Woodpecker® <b>U600 y DTE® D600</b>  <b>Ref.: 28-U032</b>	<b>18<sup>80</sup>€</b>
	Válvula solenoide ultrasonidos Woodpecker® <b>U600 y DTE® D7, D600 Y comp.</b>  <b>Ref.: 28-U025</b>	<b>28<sup>80</sup>€</b>
	Bomba de agua ultrasonidos Woodpecker® <b>U600, AP-B, y DTE® D600 y D7</b>  <b>Ref.: 28-U026</b>	<b>42<sup>80</sup>€</b>

	Descripción	Observaciones
	<p>Cable alimentación ultrasonidos Woodpecker® U600 y DTE® D600</p> <p>Ref.: <b>28-TRA014</b></p>	<p>9´80€</p>
	<p>Manguera aeropilador AP-B, AP-A y PT-A</p> <p>Ref.: <b>28-U033</b></p>	<p>Terminal dorado</p> <p>128´00€</p>
	<p>Manguera ultrasonidos AP-B</p> <p>Ref.: <b>28-U034</b></p>	<p>48´00€</p>
	<p>Pedal AP-A, AP-B y COMP</p> <p>Ref.: <b>28-U016</b></p>	<p>6´24€</p>
	<p>Soporte pieza de mano ultrasonidos y pieza de mano aeropilador AP-B (Naranja)</p> <p>Ref.: <b>28-U064</b></p>	<p>13´80€</p>
	<p>Soporte pieza de mano ultrasonidos y pieza de mano aeropilador AP-B (Blanca)</p> <p>Ref.: <b>28-U065</b></p>	<p>13´80€</p>
	<p>Válvula solenoide ultrasonidos AP-B</p> <p>Ref.: <b>28-U035</b></p>	<p>28´00€</p>
	<p>Cartucho válvula solenoide aeropilador AP-B y AP-A</p> <p>Ref.: <b>28-U036</b></p>	<p>64´80€</p>
	<p>Placa electrónica central AP-B</p> <p>Ref.: <b>28-PCB004</b></p>	<p>548´00€</p>
	<p>Fuente alimentación AP-B y AP-A</p> <p>Ref.: <b>28-TRA015</b></p>	<p>54´80€</p>











	Descripción	Observaciones
	Depósito con tapa dorada para polvos de tratamiento <b>subgingival AP-B</b> (Naranja)*  <b>Ref.: 28-U038</b>	*Dispositivos con N/S < AP23A0071PB <b>Anillos tóricos conexión Ref.: 28-U045</b>  <b>78<sup>00</sup>€</b>
	Depósito con tapa dorada para polvos de tratamiento <b>supragingival AP-B</b> (Naranja)*  <b>Ref.: 28-U039</b>	*Dispositivos con N/S < AP23A0071PB <b>Anillos tóricos conexión Ref.: 28-U045</b>  <b>78<sup>00</sup>€</b>
 <small>Imagen no disponible</small>	Kit 2 anillos tóricos conexión depósitos polvo <b>AP-B, AP-A, PT-A y PT-B</b>  <b>Ref.: 28-U045</b>	<b>2<sup>80</sup>€</b>
 <small>Imagen no disponible</small>	Kit completo 28 anillos tóricos <b>AP-B</b>  <b>Ref.: 28-U070</b>	<b>22<sup>80</sup>€</b>
 <small>Imagen no disponible</small>	Anillo tórico conexiones botellas agua <b>AP-B, AP-A, PT-A y PT-B</b>  <b>Ref.: 28-U071</b>	<b>0<sup>80</sup>€</b>  Nota: La conexión requiere de 2 anillos tóricos
	Botella 700ml <b>AP-B</b> (Naranja) con tapa dorada  <b>Ref.: 28-U040</b>	<b>38<sup>00</sup>€</b>
 <small>Imagen no disponible</small>	Botella 700ml <b>AP-B</b> y <b>AP-A</b> (Blanco) con tapa plateada  <b>Ref.: 28-U068</b>	<b>38<sup>00</sup>€</b>
	Conector rápido entrada aire comprimido <b>AP-B</b> y <b>AP-A</b>  <b>Ref.: 28-U041</b>	<b>28<sup>00</sup>€</b>
	Filtro aire <b>AP-B</b> y <b>AP-A</b>  <b>Ref.: 28-U042</b>	<b>20<sup>80</sup>€</b>
	Depósito con tapa plateada para polvo tratamiento Supragingival <b>PT-A*, AP-A*</b> y <b>AP-B*</b> (Blanco)  <b>Ref.: 28-PB0013</b>	*Dispositivos con N/S > AP23A0540A  <b>78<sup>00</sup>€</b>

	Descripción	Observaciones
	Depósito con tapa plateada para polvo tratamiento Subgingival <b>PT-A*</b> , <b>AP-A*</b> y <b>AP-B*</b> (Blanco)  <b>Ref.: 28-PB0014</b>	*Dispositivos con N/S > AP23A0540A  <b>78<sup>00</sup>€</b>
 <small>Imagen no disponible</small>	Depósito 600 ml <b>PT-A</b> y <b>PT-B</b>  <b>Ref.: 28-U057</b>	<b>22<sup>80</sup>€</b>
 <small>Imagen no disponible</small>	Depósito 1400 ml <b>PT-A</b> y <b>PT-B</b>  <b>Ref.: 28-U058</b>	<b>44<sup>80</sup>€</b>
	Soporte pieza de mano ultrasonidos <b>YZ-2L, PT-A</b>  <b>Ref.: 28-U050</b>	<b>13<sup>80</sup>€</b>
	Manguera ultrasonidos <b>YZ-2L, PT-A</b>  <b>Ref.: 28-U051</b>	<b>188<sup>00</sup>€</b>
	Válvula solenoide <b>PT-A</b> y <b>PT-B</b>  <b>Ref.: 28-U052</b>	*Confirmar antes, PT-A tiene tres solenoides distintas  <b>41<sup>80</sup>€</b>
	Válvula solenoide <b>PT-A</b> y <b>PT-B</b>  <b>Ref.: 28-U059</b>	*Confirmar antes PT-A tiene tres solenoides distintas  <b>22<sup>80</sup>€</b>
 <small>Imagen no disponible</small>	Válvula solenoide <b>PT-A</b> y <b>PT-B</b>  <b>Ref.: 28-U060</b>	*Confirmar antes PT-A tiene tres solenoides distintas  <b>54<sup>80</sup>€</b>
	Regulador caudal para <b>suministro externo</b> <b>PT-A</b>  <b>Ref.: 28-U031</b>	<b>13<sup>80</sup>€</b>
	Sistema calentador <b>PT-A</b>  <b>Ref.: 28-U053</b>	<b>138<sup>00</sup>€</b>







	Descripción	Observaciones
 <small>Imagen no disponible</small>	Kit completo 32 anillos tóricos <b>PT-A</b>  <b>Ref.: 28-U056</b>	22 <sup>80</sup> €
	Pedal multifunción <b>PT-A</b>  <b>Ref.: 28-U061</b>	13 <sup>80</sup> €
	Transformador <b>PT-A</b>  <b>Ref.: 28-TRA016</b>	42 <sup>80</sup> €
 <small>Imagen no disponible</small>	Filtro de aire <b>PT-A</b>  <b>Ref.: 28-U062</b>	28 <sup>00</sup> €
	Toma de agua <b>PT-A</b>  <b>Ref.: 28-U063</b>	6 <sup>80</sup> €
	Potenciometro kits built in <b>V3, V3 LED, UDS-N3, UDS-N3 LED</b>  <b>Ref.: 28-U001</b>	15 <sup>80</sup> €
	LED pieza de mano <b>HW-5L</b>  <b>Ref.: 28-U004</b>	6 <sup>80</sup> €
 <small>Imagen no disponible</small>	Soporte LED pieza de mano <b>HW-5L</b>  <b>Ref.: 28-U003</b>	3 <sup>80</sup> €
 <small>Imagen no disponible</small>	Punta pieza de mano <b>HW-5L</b>  <b>Ref.: 28-U049</b>	6 <sup>80</sup> €
	LED pieza de mano <b>HD-7L y HD-8L</b>  <b>Ref.: 28-U002</b>	6 <sup>80</sup> €

	Descripción	Observaciones
 <small>Imagen no disponible</small>	Soporte LED pieza de mano <b>HD-7L</b>  <b>Ref.: 28-U005</b>	<b>3'80€</b>
 <small>Imagen no disponible</small>	Soporte LED pieza de mano <b>HD-8L</b>  <b>Ref.: 28-U006</b>	<b>3'80€</b>
	Transformador <b>AT-1</b>  <b>Ref.: 28-TRA002</b>	<b>16'80€</b>
	Tubos grises paralelos <b>AT-1</b>  <b>Ref.: 28-U024</b>	<b>8'00€</b>
 <small>Imagen no disponible</small>	LED pieza de mano <b>HB-1L</b>  <b>Ref.: 28-U047</b>	<b>9'80€</b>
 <small>Imagen no disponible</small>	Soporte LED pieza de mano <b>HB-1L</b>  <b>Ref.: 28-U048</b>	<b>3'80€</b>

## Repuestos Aeropulidores / Pulidores de Bicarbonato &amp; Glicina



	Descripción	Observaciones
 <small>Imagen no disponible</small>	Cabeza pieza de mano <b>AP-1</b>  <b>Ref.: 28-PB0001</b> <span style="float: right;"><b>138<sup>00</sup>€</b></span>	Válido para modelo actual de AP-1.  Consultar
 <small>Imagen no disponible</small>	Cabeza pieza de mano <b>AP-2</b>  <b>Ref.: 28-PB0002</b> <span style="float: right;"><b>138<sup>00</sup>€</b></span>	
 <small>Imagen no disponible</small>	Kit 2 anillos tóricos conexión manguera piezas de mano <b>AP-1</b> y <b>AP-2</b>  <b>Ref.: 28-PB0003</b> <span style="float: right;"><b>2<sup>80</sup>€</b></span>	Válido para modelo actual de AP-1.  Consultar
 <small>Imagen no disponible</small>	Kit 2 anillos tóricos cabeza pieza de mano <b>AP-1</b> y <b>AP-1 PLUS</b>  <b>Ref.: 28-PB0004</b> <span style="float: right;"><b>2<sup>80</sup>€</b></span>	Válido para modelo actual de AP-1.  Consultar
 <small>Imagen no disponible</small>	Kit 2 anillos tóricos cabeza pieza de mano <b>AP-2</b> y <b>AP-2 PLUS</b>  <b>Ref.: 28-PB0005</b> <span style="float: right;"><b>2<sup>80</sup>€</b></span>	
	Aguja limpieza GRANDE <b>AP-1</b> , <b>AP-1 PLUS</b> , <b>AP-2</b> y <b>AP-2 PLUS</b>  <b>Ref.: 28-WA017</b> <span style="float: right;"><b>2<sup>80</sup>€</b></span>	
	Aguja limpieza PEQUEÑA <b>AP-1</b> , <b>AP-1 PLUS</b> , <b>AP-2</b> y <b>AP-2 PLUS</b>  <b>Ref.: 28-WA018</b> <span style="float: right;"><b>2<sup>80</sup>€</b></span>	
 <small>Imagen no disponible</small>	Conexión <b>Midwest 4 AP-H</b> y <b>AP-H PLUS</b>  <b>Ref.: 28-PB0006</b> <span style="float: right;"><b>83<sup>80</sup>€</b></span>	
 <small>Imagen no disponible</small>	Conexión tipo <b>KaVo® AP-H</b> y <b>AP-H PLUS</b>  <b>Ref.: 28-PB0007</b> <span style="float: right;"><b>83<sup>80</sup>€</b></span>	
 <small>Imagen no disponible</small>	Conexión tipo <b>NSK® AP-H</b> y <b>AP-H PLUS</b>  <b>Ref.: 28-PB0008</b> <span style="float: right;"><b>83<sup>80</sup>€</b></span>	













	Descripción	Observaciones
 <small>Imagen no disponible</small>	Conexión tipo <b>Sirona® AP-H y AP-H PLUS</b>  <b>Ref.: 28-PB0009</b> <span style="float: right;"><b>83'80€</b></span>	
 <small>Imagen no disponible</small>	Kit 2 anillos tóricos conexión <b>AP-H / AP-H PLUS</b> con piezas de mano <b>AP-1 PLUS y AP-2 PLUS</b>  <b>Ref.: 28-PB0010</b> <span style="float: right;"><b>2'80€</b></span>	
	Tapa contenedor <b>AP-H y AP-H PLUS</b>  <b>Ref.: 28-PB0011</b> <span style="float: right;"><b>14'80€</b></span>	
	Junta para contenedor <b>AP-H y AP-H PLUS</b>  <b>Ref.: 28-PB0012</b> <span style="float: right;"><b>1'80€</b></span>	
 <small>Imagen no disponible</small>	Kit completo 18 anillos tóricos <b>AP-H y AP-H PLUS*</b>  <b>Ref.: 28-PB0023</b> <span style="float: right;"><b>22'80€</b></span>	*Conexión NSK®: No incluye anillos tóricos conexión manguera. Ver Ref 28-PB0024
 <small>Imagen no disponible</small>	Kit 4 anillos tóricos conexión NSK® aeropulidores <b>AP-H y AP-H PLUS</b>  <b>Ref.: 28-PB0024</b> <span style="float: right;"><b>2'80€</b></span>	











Repuestos Motores Endodoncia y EndoActivadores













	Descripción	Observaciones
	Pieza de mano endo activador ultrasónico <b>Woodpecker® Endo 1</b> (Blanco)  <b>Ref.: 28-PM006</b> <span style="float: right;"><b>108'00€</b></span>	Roscas tipo: EMS
	Pieza de mano endo activador ultrasónico <b>DTE® Endo 1</b> (Violeta)  <b>Ref.: 28-PM007</b> <span style="float: right;"><b>108'00€</b></span>	Roscas tipo: S
 <small>Imagen no disponible</small>	Pieza de mano motor endo <b>Ai-Motor Terauchi® Black Edition</b>  <b>Ref.: 28-PM013</b> <span style="float: right;"><b>748'00€</b></span>	Color: Negro  Sin contra ángulo









	<p>Pieza de mano <b>Motopex</b></p> <p>Ref.: <b>28-PM003</b></p>	<p>Color: Blanca</p> <p>Sin contra ángulo</p> <p><b>498<sup>00</sup>€</b></p>
	<p>Pieza de mano <b>Endo Smart Plus</b></p> <p>Ref.: <b>28-PM001</b></p>	<p>Sin contra ángulo</p> <p><b>280<sup>00</sup>€</b></p>
	<p>Pieza de mano <b>Endo Radar Plus</b> (Modelo antiguo - sin modo ARI)*</p> <p>Ref.: <b>28-PM002</b></p>	<p>Color: Blanca</p> <p>Sin contra ángulo</p> <p>*No compatible con modelo nuevo</p> <p><b>348<sup>00</sup>€</b></p>
	<p>Pieza de mano <b>Endo Radar Plus</b> (Modelo nuevo - con modo ARI)*</p> <p>Ref.: <b>28-PM014</b></p>	<p>Color: Blanca</p> <p>Sin contra ángulo</p> <p>*No compatible con modelo antiguo</p> <p><b>348<sup>00</sup>€</b></p>
	<p>Pieza de mano <b>Smart-A</b></p> <p>Ref.: <b>28-PM005</b></p>	<p>Color: Naranja</p> <p>Sin contra ángulo</p> <p><b>918<sup>00</sup>€</b></p>
	<p>Pieza de mano <b>Smart-A</b></p> <p>Ref.: <b>28-PM004</b></p>	<p>Color: Blanca</p> <p>Sin contra ángulo</p> <p><b>918<sup>00</sup>€</b></p>
	<p>Cabeza contra ángulo <b>Endo Radar, Endo Smart y E-com</b></p> <p>Ref.: <b>28-ME001</b></p>	<p><b>180<sup>00</sup>€</b></p>
	<p>Cabeza contra ángulo motores endo Woodpecker® / DTE®:</p> <p><b>Endo Radar Plus</b>                      <b>Ai-Motor</b>  <b>Endo Smart +</b>  <b>Motopex</b></p> <p>Ref.: <b>28-ME004</b></p>	<p>Inluye: Boquilla de lubricación</p> <p><b>280<sup>00</sup>€</b></p>
	<p>Cabeza contra ángulo <b>Smart-A</b></p> <p>Ref.: <b>28-ME007</b></p>	<p>Inluye: Boquilla de lubricación</p> <p>*Recubrimiento aislante</p> <p><b>348<sup>00</sup>€</b></p>
	<p>Cabeza contra ángulo motores endo Woodpecker® / DTE® con movimiento <b>Rotatorio</b> y movimiento <b>Vertical</b> (arriba-abajo)</p> <p><b>Endo Radar Plus</b>                      <b>Ai-Motor</b>  <b>Endo Smart +</b>                              <b>Smart-A</b>  <b>Motopex</b></p> <p>Ref.: <b>28-CA161RR</b></p>	<p>Inluye: Boquilla de lubricación</p> <p>Movimiento VERTICAL  +  Movimiento ROTATORIO</p> <p><b>328<sup>00</sup>€</b></p>

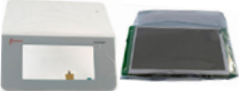

	<p>Gancho labial motores Endo Woodpecker® y DTE®:</p> <p><b>Endo Radar</b> <b>Endo Radar "Plus"</b> <b>Motopex</b></p> <p><b>Ai-Motor</b> <b>Smart A</b></p> <p>Ref.: <b>28-WA012</b></p>	<p>Pack: 2 Unidades</p> <p>Compatible con Morita Triauto</p> <p><b>10´80€</b></p>
	<p>Cable medición motores <b>Endo Radar Plus</b> y <b>Endo Radar</b>.</p> <p>Ref.: <b>28-CAB001</b></p>	<p><b>18´80€</b></p>
	<p>Cable medición motor Endo <b>Ai-Motor</b></p> <p>Ref.: <b>28-CAB007</b></p>	<p><b>18´80€</b></p>
	<p>Cable gancho limas</p> <p><b>Endo Radar</b> <b>Endo Radar "Plus"</b> <b>Motopex</b></p> <p><b>Ai-Motor</b> <b>Smart A</b></p> <p>Ref.: <b>28-CAB002</b></p>	<p><b>19´80€</b></p>
	<p>Cable mini USB (Base-pieza de mano) <b>E-com+</b></p> <p>Ref.: <b>28-CAB004</b></p>	<p><b>18´00€</b></p>
	<p>Cable USB (Base-pieza de mano) <b>Endo Radar</b> y <b>Endo Radar Plus</b></p> <p>Ref.: <b>28-CAB005</b></p>	<p><b>28´80€</b></p>
	<p>Cable medición <b>Motopex</b></p> <p>Ref.: <b>28-CAB006</b></p>	<p><b>28´00€</b></p>
 <p>Imagen no disponible</p>	<p>Cable transformador / medición <b>Smart-A</b></p> <p>Ref.: <b>28-CAB008</b></p>	<p><b>28´00€</b></p>
	<p>Funda aislante motores Endo Woodpecker® / DTE®:</p> <p><b>Endo Radar Plus</b> <b>Endo Smart +</b> <b>Motopex</b></p> <p><b>Ai-Motor</b></p> <p>Ref.: <b>28-WA008</b></p>	<p>1 Unidad</p> <p><b>4´80€</b></p>
 <p>Imagen no disponible</p>	<p>Funda protectora <b>Endo 3</b></p> <p>Ref.: <b>28-WA011</b></p>	<p>1 Unidad</p> <p><b>3´80€</b></p>

	Descripción	Observaciones
	Base <b>Motopex</b>  <b>Ref.: 28-BAS008</b>	78 <sup>00</sup> €
	Base <b>Endo Smart +</b>  <b>Ref.: 28-BAS017</b>	78 <sup>00</sup> €
	Base <b>Smart-A</b>  <b>Ref.: 28-BAS009</b>	Color: Naranja  228 <sup>00</sup> €
	Base <b>Smart-A</b>  <b>Ref.: 28-BAS010</b>	Color: Blanca  228 <sup>00</sup> €
	Base <b>Ai-Motor Terauchi® Black Edition</b>  <b>Ref.: 28-BAS018</b>	108 <sup>00</sup> €
	Base Endo activador <b>Endo1</b>  <b>Ref.: 28-BAS002</b>	Color: Blanco  28 <sup>00</sup> €
	Base Endo activador <b>Endo1</b>  <b>Ref.: 28-BAS003</b>	Color: Violeta  28 <sup>00</sup> €
	Base Endo activador <b>Endo3</b>  <b>Ref.: 28-BAS013</b>	98 <sup>00</sup> €
	Pedal <b>Smart-A</b>  <b>Ref.: 28-ME009</b>	Color: Naranja  208 <sup>00</sup> €
	Pedal <b>Smart-A</b>  <b>Ref.: 28-ME008</b>	Color: Blanca  208 <sup>00</sup> €

	Descripción	Observaciones
	<p>Soporte LED <b>E-com+</b></p> <p>Ref.: <b>28-U029</b></p>	<p><b>8'00.€</b></p>











	Descripción	Observaciones
	Cable micromotor LED SPM-58L Woodpecker® <b>Implanter LED</b> y <b>DTE® Implant X LED</b>  <b>Ref.: 28-MI001</b> <span style="float: right;"><b>118´00.€</b></span>	Longitud: 180cm Conector gris 6 pines
 <small>Imagen no disponible</small>	Cable micromotor LED SPM-58L Woodpecker® <b>Implanter LED PLUS</b> y <b>DTE® Implant X LED Plus</b>  <b>Ref.: 28-MI006</b> <span style="float: right;"><b>118´00.€</b></span>	Longitud: 180cm Conector azul 10 pines
	Placa electrónica Woodpecker® <b>Implanter LED</b> y <b>DTE® Implant X LED</b>  <b>Ref.: 28-PCB003</b> <span style="float: right;"><b>280´00.€</b></span>	
	Display Woodpecker® <b>Implanter LED</b> y <b>DTE® Implant X LED</b>  <b>Ref.: 28-MI002</b> <span style="float: right;"><b>218´80.€</b></span>	
	Bomba Woodpecker® <b>Implanter LED, Implanter LED Plus, DTE® Implant X LED, Implant X LED Plus, Surgic Touch LED, Surgic X LED</b> y sus versiones sin luz  <b>Ref.: 28-MI003</b> <span style="float: right;"><b>139´80.€</b></span>	
	Cable suministro eléctrico Woodpecker® <b>Implanter LED, Implanter LED Plus, DTE® Implant X LED, Implant X LED Plus, Surgic Touch LED, Surgic X LED</b> y sus versiones sin luz  <b>Ref.: 28-TRA013</b> <span style="float: right;"><b>49´80.€</b></span>	
 <small>Imagen no disponible</small>	Pedal multifuncional con cable Woodpecker® <b>Implanter LED, Implanter LED Plus, DTE® Implant X LED, Implant X LED Plus</b> y sus versiones sin luz  <b>Ref.: 28-MI005</b> <span style="float: right;"><b>84´80.€</b></span>	Longitud cable: 280cm
	Pedal multifuncional con cable Woodpecker® <b>Surgic Touch LED, Surgic X LED</b> y sus versiones sin luz  <b>Ref.: 28-U069</b> <span style="float: right;"><b>84´80.€</b></span>	Longitud cable: 280cm
 <small>Imagen no disponible</small>	Soporte goma Woodpecker® piezas de mano y micromotor  <b>Ref.: 28-MI007</b> <span style="float: right;"><b>13´80.€</b></span>	
 <small>Imagen no disponible</small>	Soporte suero Woodpecker® <b>Implanter LED, Implanter LED Plus, DTE® Implant X LED, Implant X LED Plus, Surgic Touch LED, Surgic X LED</b> y sus versiones sin luz  <b>Ref.: 28-MI009</b> <span style="float: right;"><b>10´80.€</b></span>	

Para repuestos contra ángulos Woodpecker® consultar sección repuestos rotatorio.

SI NO ENCUENTRAS EL REPUESTO QUE BUSCAS, ¡CONSÚLTANOS!  
 Precios: impuestos, portes y mano de obra no incluidos.

## Repuestos Localizador de Ápices









	Descripción	Observaciones
	<p>Gancho labial localizadores de ápices y motores Endo con localizador de ápices Woodpecker® y DTE®:</p> <p><b>Woodpex V</b> <b>Ai-PEX</b> <b>Minipex</b></p> <p><b>Endo Radar</b> <b>Endo Radar "Plus"</b> <b>Motopex</b></p> <p><b>Ai-Motor</b> <b>Smart A</b></p> <p>Ref.: <b>28-WA012</b></p>	<p>Pack: 2 Unidades</p> <p>Compatible con Morita Triauto</p> <p>10'80€</p>
	<p>Punta test pulpa <b>Ai-Pex</b>.</p> <ul style="list-style-type: none"> <li>- Fino para piezas dentales con coronas metálicas.</li> <li>- Grueso para todas las piezas dentales.</li> </ul> <p>Ref.: <b>28-WA014</b></p>	<p>Pack: 2 Unidades</p> <p>12'80€</p>
	<p>Cable medición motores.</p> <p><b>Woodpex I</b> <b>Woodpex III</b> <b>Woodpex V</b></p> <p><b>DPEX I</b> <b>DPEX III</b></p> <p>Ref.: <b>28-CAB001</b></p>	<p>18'80€</p>
	<p>Cable gancho labial <b>Minipex</b>.</p> <p>Ref.: <b>28-CAB003</b></p>	<p>15'80€</p>
	<p>Cable gancho limas.</p> <p><b>Woodpex I</b> <b>Woodpex III</b> <b>Woodpex V</b></p> <p><b>DPEX I</b> <b>DPEX III</b> <b>DPEX III</b></p> <p><b>Ai-Pex</b> <b>Minipex</b></p> <p>Ref.: <b>28-CAB002</b></p>	<p>19'80€</p>
	<p>Cable medición <b>Ai-Pex</b>.</p> <p>Ref.: <b>28-CAB007</b></p>	<p>18'80€</p>
	<p>Transformador <b>Woodpex III, Woodpex V y DPEX III</b>.</p> <p>Ref.: <b>28-TRA002</b></p>	<p>16'80€</p>
 <p>Imagen no disponible</p>	<p>Transformador <b>Minipex</b>.</p> <p>Ref.: <b>28-TRA004</b></p>	<p>16'80€</p>
	<p>Transformador <b>Ai-Pex</b>.</p> <p>Ref.: <b>28-TRA010</b></p>	<p>28'00€</p>
	<p>Batería <b>Woodpex III, Woodpex V y DPEX III</b>.</p> <p>Ref.: <b>28-BAT004</b></p>	<p>19'80€</p>



	Descripción	Observaciones
	Batería <b>Ai-Pex</b> .  <b>Ref.: 28-BAT007</b>	28'80€

## Repuestos Sistema de Obturación



	Descripción	Observaciones
	Batería Sistema de Obturación Gutapercha <b>Fi-G</b> .  <b>Ref.: 28-BAT005</b>	58'00€
	Batería Sistema de Obturación Gutapercha <b>Fi-P</b> y <b>Fi-E</b> .  <b>Ref.: 28-BAT006</b>	58'00€
	Transformador Sistema de Obturación Gutapercha <b>Fi-G</b> , <b>Fi-P</b> y <b>Fi-E</b> .  <b>Ref.: 28-TRA012</b>	58'00€
	Martillo accionador Sistema de Obturación Gutapercha <b>Fi-G</b> .  <b>Ref.: 28-SO001</b>	66'80€
	Cierre y junta martillo accionador Sistema de Obturación Gutapercha <b>Fi-G</b> .  <b>Ref.: 28-SO003</b>	Para Ref.: 28-SO001  3'80€
	Gatillo Sistema de Obturación Woodpecker® <b>Fi-G</b> .  <b>Ref.: 28-SO002</b>	8'00€
	Base de carga Sistema de Obturación Gutapercha <b>Fi-G</b> .  <b>Ref.: 28-BAS006</b>	58'00€
	Base de carga Sistema de Obturación Gutapercha <b>Fi-P</b> .  <b>Ref.: 28-BAS007</b>	58'00€

	Descripción	Observaciones
	Anillo limpiador Sistema de Obturación Gutapercha Fi-E.  <b>Ref.: 28-SO006</b>	<b>5'80€</b>
	Base de carga Sistema de Obturación Gutapercha Fi-E.  <b>Ref.: 28-BAS014</b>	<b>48'00€</b>
 <small>Imagen no disponible</small>	Pieza de mano Fi-E Blanco  <b>Ref.: 28-PM008</b>	<b>478'00€</b>
 <small>Imagen no disponible</small>	Pieza de mano Fi-P Blanco  <b>Ref.: 28-PM009</b>	<b>280'00€</b>







## Repuestos Imágen Radiografía Oral Digital



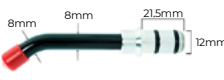
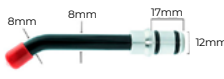
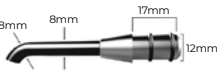
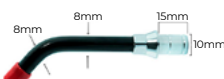





	Descripción	Observaciones
	Transformador <b>i-Scan</b> .  <b>Ref.: 28-TRA011</b>	<b>49'80€</b>
	Funda silicona <b>i-Sensor H1</b> .  <b>Ref.: 28-WA009</b>	<b>3'80€</b>
	Funda silicona <b>i-Sensor H2</b> .  <b>Ref.: 28-WA010</b>	<b>3'80€</b>
	Soporte goma <b>i-Sensor H1 y H2</b> .  <b>Ref.: 28-WA015</b>	<b>6'80€</b>

Guías de luz / Fibra Óptica Lámparas Fotocurado

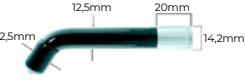
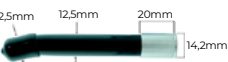







	Descripción	Observaciones
	<p>Guía de luz / Fibra óptica <b>Woodpecker® LED.G, LED.C, LED.D, LED.F, LED.P, LED.B y LUX E PLUS.</b></p> <p><b>Ref.: 28-FO001</b> <span style="float: right;"><b>18´80€</b></span></p>	<p>Campo Fotocurado: 8mm</p>
	<p>Guía de luz / Fibra óptica, <b>Woodpecker® LED.H LED.H ORTHO y BA OPTIMA 10.</b></p> <p><b>Ref.: 28-FO002</b> <span style="float: right;"><b>18´80€</b></span></p>	<p>Campo Fotocurado: 8mm</p>
	<p>Guía de luz / Fibra óptica, Biselada <b>Woodpecker® LED.H, LED.H ORTHO y BA OPTIMA 10.</b></p> <p><b>Ref.: 28-FO003</b> <span style="float: right;"><b>22´80€</b></span></p>	<p>Campo Fotocurado: 8mm</p>
	<p>Guía de luz / Fibra óptica 8mm diám. / conector: Ø10mm</p> <p><b>Ref.: 44-225</b> <span style="float: right;"><b>18´80€</b></span></p>	<p>Campo Fotocurado: 8mm</p>
	<p>Punta DTE® <b>iLED MAX</b></p> <p><b>Ref.: 28-FO008</b> <span style="float: right;"><b>59´80€</b></span></p>	<p>Metálica Campo fotocurado: 10mm</p>
	<p>Tapa transparente punta DTE® <b>iLED MAX.</b></p> <p><b>Ref.: 28-LF006</b> <span style="float: right;"><b>16´80€</b></span></p>	
	<p>Tapa transparente punta metálica DTE® <b>iLED PLUS</b> (modelo antiguo), 1ud.</p> <p><b>Ref.: 28-LF004</b> <span style="float: right;"><b>0´90€</b></span></p>	<p style="text-align: right;"><b>HASTA AGOTAR</b></p>
	<p>Tapa transparente punta metálica DTE® <b>iLED PLUS</b> (modelo nuevo) y B-Cure Plus, 1ud.</p> <p><b>Ref.: 28-LF005</b> <span style="float: right;"><b>0´90€</b></span></p>	<p style="text-align: right;"><b>HASTA AGOTAR</b></p>
	<p>Punta DTE® <b>B-Cure Plus metálica.</b></p> <p><b>Ref.: 28-FO010</b> <span style="float: right;"><b>64´80€</b></span></p>	<p>Metálica Campo Fotocurado: 8mm</p> <p style="text-align: right;"><b>HASTA AGOTAR</b></p>
 <p style="font-size: small;">Imagen no disponible</p>	<p>Punta DTE® <b>VV Light</b></p> <p><b>Ref.: 28-FO011</b> <span style="float: right;"><b>39´80€</b></span></p>	<p>Metálica Campo Fotocurado: 10mm</p>

	Descripción	Observaciones
 <p>Imagen no disponible</p>	<p>Guía de luz / Fibra óptica DTE® <b>B-Cure (modelo antiguo)</b>.</p> <p><b>Ref.: 28-FO009</b> <span style="float: right;"><b>36<sup>80</sup>€</b></span></p>	<p>Campo Fotocurado: 8mm</p> <p style="text-align: right;"><b>HASTA AGOTAR</b></p>
	<p>Guía de luz / Fibra óptica Woodpecker® <b>LUX VI</b>.</p> <p><b>Ref.: 28-FO004</b> <span style="float: right;"><b>18<sup>80</sup>€</b></span></p>	<p>Campo Fotocurado: 8mm</p>
	<p>Guía de luz / Fibra óptica Woodpecker® <b>X-cure standard</b>.</p> <p><b>Ref.: 28-FO005</b> <span style="float: right;"><b>44<sup>80</sup>€</b></span></p>	<p>Campo Fotocurado: 10mm</p>
	<p>Guía de luz / Fibra óptica Woodpecker® <b>X-cure biselada</b></p> <p><b>Ref.: 28-FO007</b> <span style="float: right;"><b>44<sup>80</sup>€</b></span></p>	<p>Campo Fotocurado: 10mm</p>
	<p>Punta Woodpecker® <b>O-Star</b></p> <p><b>Ref.: 28-FO006</b> <span style="float: right;"><b>108<sup>00</sup>€</b></span></p>	<p>Metálica Campo Fotocurado: 10mm</p>
	<p>Lente de cura de puntos lámpara Woodpecker® O-Star, iLed MAX</p> <p><b>Ref.: 28-LF007</b> <span style="float: right;"><b>19<sup>80</sup>€</b></span></p>	
	<p>Guía de luz / Fibra óptica TKD® Moon Ø8mm.</p> <p><b>Ref.: 40-53001</b> <span style="float: right;"><b>118<sup>00</sup>€</b></span></p>	<p>Campo Fotocurado: 8mm</p>



Baterías lámparas de fotocurado





	Descripción	Observaciones
	<p>Batería <b>ECO LED1</b>, Woodpecker® <b>LED.H</b> y <b>LED.H ORTHO</b></p> <p><b>Ref.: 28-BAT001</b> <span style="float: right;"><b>19<sup>80</sup>€</b></span></p>	
	<p>Batería Woodpecker® <b>LUX VI</b></p> <p><b>Ref.: 28-BAT004</b> <span style="float: right;"><b>19<sup>80</sup>€</b></span></p>	

	Descripción	Observaciones
	Batería lámpara DTE® <b>iLED</b> "todos los modelos" y Woodpecker® <b>LED.D, X-Cure y LUX E PLUS.</b>  <b>Ref.: 28-BAT002</b>	19'80.€
	Batería lámpara Woodpecker® <b>LED.C</b>  <b>Ref.: 28-BAT003</b>	19'80.€
	Batería lámpara DTE® <b>B-Cure</b>  <b>Ref.: 28-BAT011</b>	34'80.€
	Batería localizador de ápices Woodpecker <b>Minipex</b>  <b>Ref.: 28-BAT012</b>	19'80.€
	Batería lámpara <b>O-Star</b> (Modelo con conexión)  <b>Ref.: 28-BAT013</b>	*Estación base con conexión 28-BAS012  58'00.€
	Batería lámpara <b>O-Star</b> (Modelo contactless)*  <b>Ref.: 28-BAT014</b>	*Estación base contactless 28-BAS020  58'00.€







▶ Protectores vista lámparas de fotocurado  





	Descripción	Observaciones
	Protector para vista <b>LED.L, LED.D, LED.G, LED.H, LED.H ORTHO, LED.C, LED.B, B-Cure, LUX E Plus.</b>  <b>Ref.: 28-LF001</b>	5'80.€
	Protector para vista <b>LUX VI</b>  <b>Ref.: 28-LF003</b>	5'80.€
	Protector para vista <b>iLED "todos los modelos"</b>  <b>Ref.: 28-LF002</b>	5'80.€

	Descripción	Observaciones
 <p>Imagen no disponible</p>	Protector para vista <b>O-Star</b>  Ref.: <b>28-LF009</b>	Gafas protectoras modo check Ver lista aparatología.  5'80€
	Protector para vista <b>VV Light</b>  Ref.: <b>28-LF010</b>	5'80€

► Bases lámparas fotocurado



	Descripción	Observaciones
	Base <b>ECO LED1</b> y <b>Woodpecker® LED.H</b>  Ref.: <b>28-BAS001</b>	Color: Dorado  28'00€
	Base lámpara <b>DTE® iLED "todos los modelos"</b>  Ref.: <b>28-BAS002</b>	Color: Blanco  28'00€
	Base lámpara <b>DTE® iLED "todos los modelos"</b>  Ref.: <b>28-BAS003</b>	Color: Violeta  28'00€
	Base lámpara <b>Woodpecker® LED.D</b>  Ref.: <b>28-BAS004</b>	18'80€
	Base lámpara <b>Woodpecker® LED.C</b>  Ref.: <b>28-BAS005</b>	18'80€
	Base lámpara <b>Woodpecker® X-Cure "Golden"</b>  Ref.: <b>28-BAS016</b>	83'80€
	Base lámpara <b>Woodpecker® X-Cure "Silver"</b>  Ref.: <b>28-BAS015</b>	83'80€

	Descripción	Observaciones
	Base lámpara <b>DTE® B-Cure</b>  <b>Ref.: 28-BAS011</b> <span style="float: right;"><b>28´00€</b></span>	
	Base lámpara <b>Woodpecker® O-Star</b> (Modelo con conexión)*  <b>Ref.: 28-BAS012</b> <span style="float: right;"><b>64´80€</b></span>	*Revisar tipo de conexión de carga base-pieza de mano
	Base lámpara <b>Woodpecker® O-Star</b> (Modelo contactless)*  <b>Ref.: 28-BAS020</b> <span style="float: right;"><b>64´80€</b></span>	*Revisar tipo de conexión de carga base-pieza de mano
 <small>Imagen no disponible</small>	Base lámpara <b>Woodpecker® LUX E PLUS</b>  <b>Ref.: 28-BAS019</b> <span style="float: right;"><b>18´80€</b></span>	

Transformadores lámparas fotocurado





	Descripción	Observaciones
	Transformador <b>Woodpecker® LED.H, DTE ILED, LED.C, LED.D, B-Cure, O-Star, Lux E Plus, y comp.</b>  <b>Ref.: 28-TRA002</b> <span style="float: right;"><b>16´80€</b></span>	
	Transformador lámpara <b>Woodpecker® LUX VI</b>  <b>Ref.: 28-TRA001</b> <span style="float: right;"><b>16´80€</b></span>	
	Transformador lámpara <b>Woodpecker® X-Cure</b>  <b>Ref.: 28-TRA003</b> <span style="float: right;"><b>19´80€</b></span>	

Mangueras para lámparas fotocurado



	Descripción	Observaciones
	Manguera lámpara <b>TKD® Moon</b>  <b>Ref.: 40-91A2000</b> <span style="float: right;"><b>52´80€</b></span>	Open end Longitud: 160cm Color: Gris oscuro (RAL 7038) Regulación de spray  Compatible lámpara <b>Castellini T-LED</b>

	Descripción	Observaciones
	<p>Fuente de alimentación para dotar de luz a sillones dentales sin luz. Regulador de retardo apagado luz por manguera.</p> <p><b>Ref.: 44-480</b></p>	<p><b>Tensión alimentación:</b> 12 – 30 V. <b>Tensión salida:</b> 2,5 – 3,5 V. Actuación neumática</p> <p><b>109<sup>80</sup>€</b></p>
	<p>Soporte instrumento polivalente.</p> <p><b>Ref.: 44-650</b></p>	<p><b>9<sup>80</sup>€</b></p>



# RUMAR

RCD



## ▶ REPUESTOS COMPRESORES Y SECADORES DÜRR® DENTAL

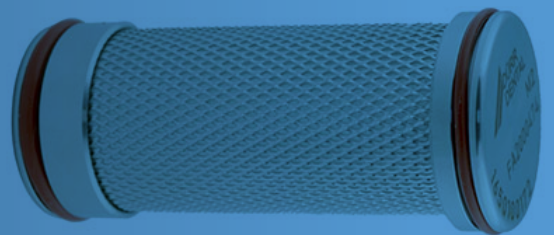
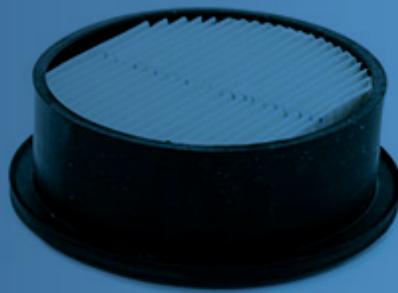
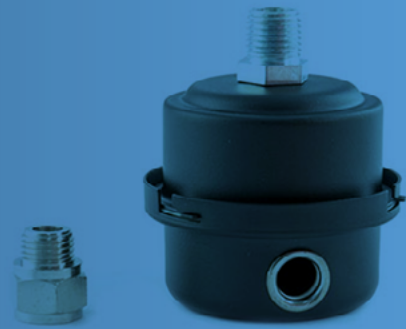
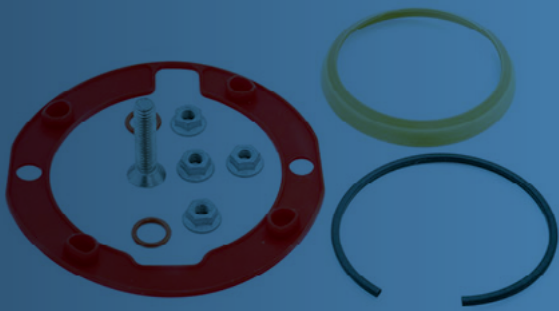
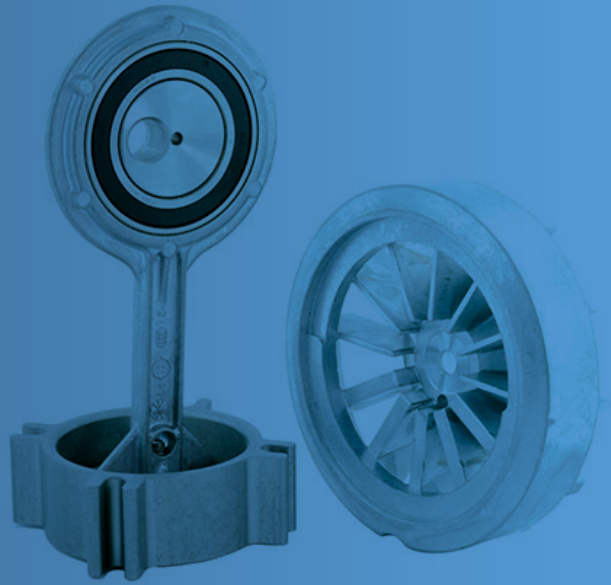







Compresores DÜRR® PRIMO, DUO, TRIO Y CUATRO



	Descripción	Observaciones
	Kit reparación compresor 51 / 52 (PRIMO, DUO, TRIO y CUATRO). <b>Ref.: 68-11101</b> (Ref. Dürr®: 5110.992.00)	<b>Incluye:</b> 5150.981.00 kit juntas culata, 5110.105.50 culata <b>235<sup>80</sup>€</b>
	Filtro compresor 51 / 52 (PRIMO, DUO, TRIO y CUATRO). <b>Ref.: 68-11102</b> (Ref. Dürr®: 0832.982.00)	<b>53<sup>80</sup>€</b>



Compresores DÜRR® Tornado 70 / 130



	Descripción	Observaciones
	Filtro redondo compresor Tornado 70 / 130. <b>Ref.: 68-13101</b> (Ref. Dürr®: 5430.982.00)	<b>34<sup>80</sup>€</b>
	Kit reparación compresor Tornado 70 / 130. <b>Ref.: 68-13102</b> (Ref. Dürr®: 5430.981.00)	<b>Incluye:</b> Cilindro, aro compresión, tornillo pistón y 2 juntas culata. <b>246<sup>80</sup>€</b>
	Filtro + Porta filtro redondo compresor Tornado 70 / 130. <b>Ref.: 68-13103</b> (Ref. Dürr®: 0852.001.00)	<b>63<sup>80</sup>€</b>
	Biela + pistón compresor Tornado 70 / 130. <b>Ref.: 68-13104</b> (Ref. Dürr®: 5430.984.00)	<b>565<sup>80</sup>€</b>

Compresores DÜRR® Tornado T1 y T2



	Descripción	Observaciones
	Juego filtros compresor Tornado T1 y T2. <b>Ref.: 68-15101</b> (Ref. Dürr®: 5180.980.60)	<b>Incluye:</b> 1610.121.00 filtro anual superior, 1650200323 filtro secador membra- na 1650 / sinterizado, 5180.982.00 filtro admisión. <b>142<sup>80</sup>€</b>
	Filtro admisión compresor DÜRR® Tornado T1 y T2. <b>Ref.: 68-15104</b> (Ref. Dürr®: 5180.982.00)	<b>50<sup>80</sup>€</b>
	Kit reparación juntas cilindro compresor Tornado T1 y T2. <b>Ref.: 68-15102</b> (Ref. Dürr®: 5180.981.00)	<b>Incluye:</b> Junta interior, aro compresión pistón, tornillo sujeción aro de compresión. <b>72<sup>80</sup>€</b>
	Presostato compresor Tornado T1 y T2. <b>Ref.: 68-15103</b> (Ref. Dürr®: 5180.011.00E)	<b>200<sup>80</sup>€</b>

## Secadores DÜRR®



	Descripción	Observaciones
	Filtro secador todos los modelos.  <b>Ref.: 68-18101</b> (Ref. Dürr®: 1610.121.00)	64 <sup>80</sup> €
	Filtro secador membrana 1650 / Sinterizado + Colector + Anillo tórico.  <b>Ref.: 68-18103</b> (Ref. Dürr®: 1650100147) (Antigua: 165010100)	Antigua: 165010100 (Antes no incluía el conector)  62 <sup>80</sup> €
	Filtro HEPA secador todos los modelos.  <b>Ref.: 68-18104</b> (Ref. Dürr®: 1650100172) (Antigua 1640.981.00)	228 <sup>00</sup> €

SAR

## ▶ SISTEMAS DE ASPIRACIÓN Y REPUESTOS

- Motores aspiración Luzzani® Dental y repuestos
- Motores aspiración, centrifugadoras y separadores de amalgama METASYS®
- Válvulas y accesorios METASYS®
- Repuestos aspiraciones METASYS®
- Conectores META connect (METASYS®)
- Motores aspiración, centrifugadoras y separadores de amalgama Dürr® Dental
- Repuestos aspiraciones Dürr® Dental
- Conectores Dürr® connect
- Soportes aspiración Luzzani® Dental
- Mangueras y tubos aspiración
- Terminales de aspiración y adaptadores



# MOTORES ASPIRACIÓN LUZZANI® DENTAL Y SUS REPUESTOS

## Motor de aspiración seca AIRMATIC



- Máxima fiabilidad + Máximo silencio.
- Puede funcionar de forma continuada.
- Depresión estática: 1.300 mm de agua aprox.
- Caudal de aire: 1.200 l/min.

- Funcionamiento: aspiración y compresión.
- Ausencia completa de ruido.
- **Garantía:** 1 año.

### MOTOR ASÍNCRONO MONOFÁSICO

Tensión alimentación	220V / 50Hz
Potencia de absorción	Wa 415
Absorción	A 1,86
Condensación	μ F10
Cos φ	0,96
Velocidad de rotación	2.810 rpm
Modo de trabajo	Continuo
Depresión estática	1.300 mm de agua
Caudal de aire	1.200 l/min.

### DIAGRAMA DE DEPRESIÓN

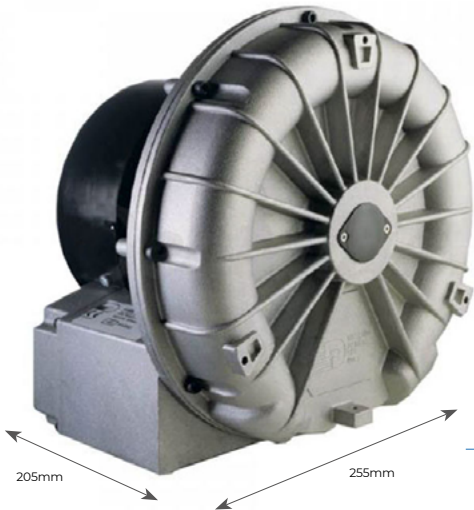
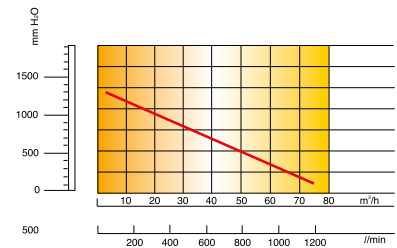

Ref.: **39-8AIRMAT**

**451<sup>80€</sup>**

## Repuestos motor de aspiración seca AIRMATIC

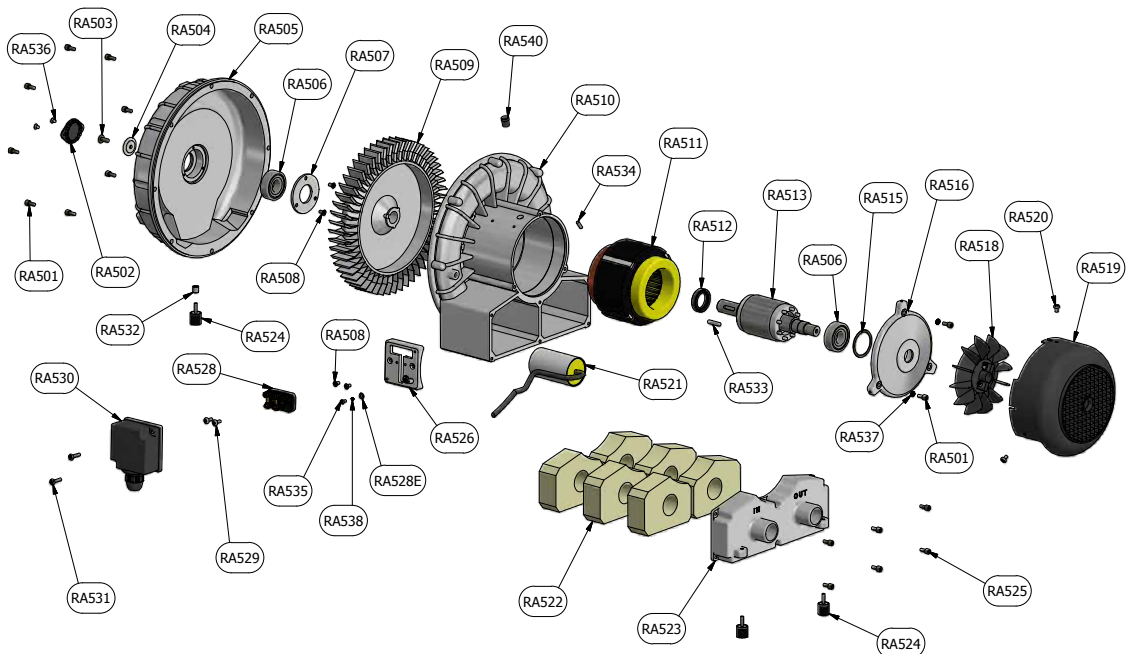

### Descripción

### Observaciones

	Rodamientos (RA506)	<b>Ref.: 39-8RA506</b>	<b>19<sup>80€</sup></b>
	Silenciadores (RA522)	<b>Ref.: 39-8RA522</b>	<b>20<sup>80€</sup></b>

# MOTORES ASPIRACIÓN, CENTRIFUGADORAS Y SEPARADORES DE AMALGAMA METASYS®

Motores de aspiración METASYS®



## Rotor separador centrífugo

Módulo separador que, gracias a su fuerza centrífuga, garantiza una separación continua y perfecta incluso con grandes cargas de espuma. Para que la bomba de vaciado funcione de por vida, la fiabilidad de la separación debe estar garantizada.



## Desagüe de las aguas residuales más alto

Un desagüe de aguas residuales colocado más alto permite una conexión cómoda con el desagüe o el separador de amalgama. Con ello ya no se requiere ninguna otra instalación para una posible elevación necesaria del aparato de aspiración.

## Regulación de presión negativa controlada por frecuencia\*

Según los requisitos de potencia, la regulación de la presión negativa se realiza mediante un control de frecuencia que proporciona a las cánulas una gran presión negativa constante de 180 mbar. Además, la función controlada por frecuencia reduce considerablemente el consumo energético.  
\* Solo para EXCOM Hybrid 5

## Un eje de motor

Un eje de motor para mover tanto el generador de presión negativa como la separación, al mismo tiempo que permite el funcionamiento simultáneo de ambos módulos. Esto impide el peligro de un posible derrame de líquido provocado por una separación que no esté funcionando dentro de una bomba de vacío en marcha.

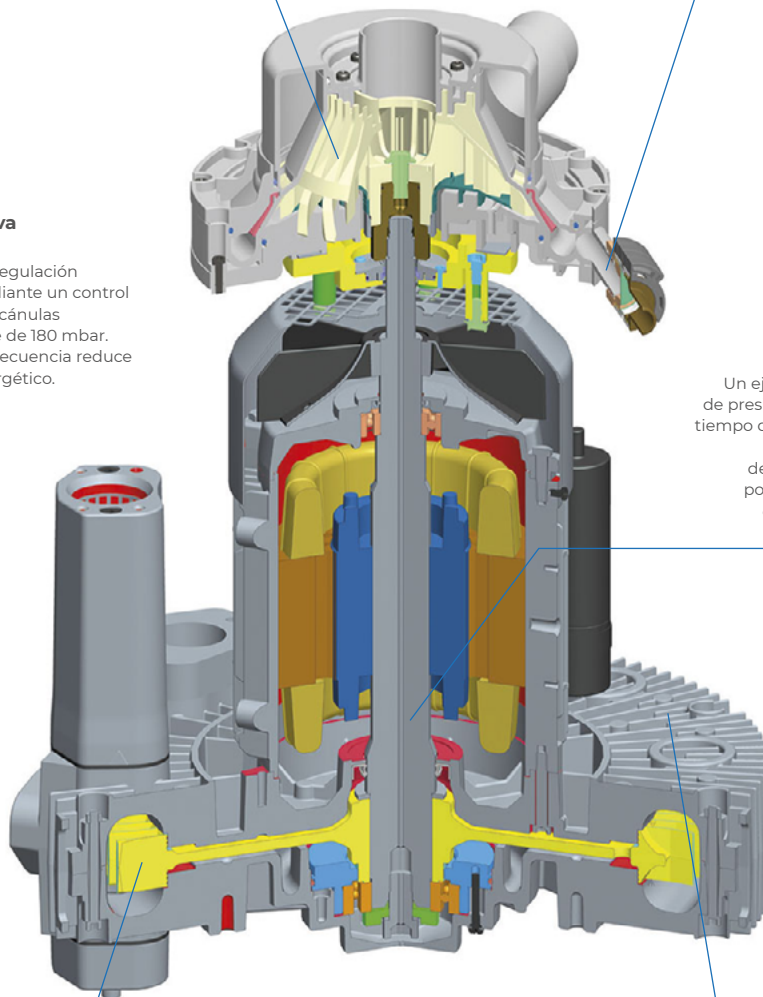

## Rueda de turbina de aluminio

La rueda de turbina de aluminio de marcha libre garantiza la seguridad del funcionamiento a largo plazo. No se utilizan ruedas de plástico.

## Aletas de refrigeración que optimizan el caudal de aire

El diseño especial de estas aletas optimizadas garantiza una mejor refrigeración y una mayor protección contra el sobrecalentamiento. El caudal de aire y refrigeración eficiente que proporcionan estas aletas de refrigeración permite un rápido descenso del calor.

## Garantía de 36 meses\*

\*Excepto el EXCOM Hybrid 1, que tiene una garantía de 24 meses.

# MOTORES ASPIRACIÓN HÍBRIDA (HÚMEDA Y SECA) CENTRALIZADOS SIN SEPARACIÓN AMALGAMA

Motores de aspiración híbrida METASYS® sin separador de amalgama

**METASYS**



EXCOM Hybrid 1S



EXCOM Hybrid 1



EXCOM Hybrid 2



EXCOM Hybrid 5

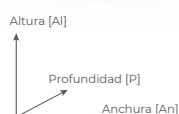

	EXCOM Hybrid 1S	EXCOM Hybrid 1	EXCOM Hybrid 2	EXCOM Hybrid 5
Tensión de alimentación	230 V AC	230 V AC	230 V AC	230 V AC / 400 V AC
Frecuencia	50 / 60 Hz	50 / 60 Hz	50 / 60 Hz	50 / 60 Hz
Consumo máx. corriente	3,5 / 4,5 A	6,7 A	6,7 A	9,0 / 10,0 A // 4,3 / 4,4 A
Consumo máx. potencia	0,55 / 0,63 kW	0,94 / 1,1 kW	1,1 / 1,3 kW	1,5 / 1,75 kW
Temperatura máx. ambiente	40° C	40° C	40° C	40° C
Volumen aspiración	1.100 l/min	1.100 / 1.300 l/min	1.450 / 1.750 l/min	2.000 / 2.400 l/min
Zona presión negativa regulada	120 / 140 mbar	180 mbar	180 mbar	180 mbar
Nivel sonoro	63 dB (A)	57 / 62 dB (A)	58 / 63 dB (A)	64 / 68 dB (A)
Dimensiones (Al x An x P) en mm	530 x 350 x 320	570 x 422 x 400	580 x 450 x 400	620 x 460 x 455
Peso	15 Kg	22 kg	27 kg	30 kg
Duración conexión	100%	100%	100%	100%
Tasa separación	-	-	-	-
Número de equipos	1 equipo	Hasta 2 equipos	Hasta 3 equipos	Hasta 5 equipos
Suministro incluye	Kit básico instalación* (excepto tubo desahogo)	Kit básico instalación*	Kit básico instalación*	Kit básico instalación*
Garantía	24 meses**	36 meses**	36 meses**	36 meses**

\* Incluye: 1m. tubo desahogo, 1m. tubo entrada y kit básico de adaptadores para la instalación.

\*\* Mínimo de mantenimiento requerido. **Consultar**

## Descripción

## Observaciones

EXCOM Hybrid 1S, con unidad de control

Ref.: **98-010154** (Ref. Metasys®: 104000002 / 02010154)

**1.380<sup>00</sup>€**

1 equipo

EXCOM Hybrid 1, con unidad de control

Ref.: **98-010311** (Ref. Metasys®: 104000005 / 02010311)

**1.800<sup>00</sup>€**

Hasta 2 equipos

EXCOM Hybrid 2, con unidad de control

Ref.: **98-010312** (Ref. Metasys®: 104000006 / 02010312)

**2.580<sup>00</sup>€**

Hasta 3 equipos

EXCOM Hybrid 5 (230 V), con unidad de control

Ref.: **98-010313** (Ref. Metasys®: 104000008 / 02010313)

**3.488<sup>00</sup>€**

Hasta 5 equipos

BAJO PEDIDO

EXCOM Hybrid 5 (400 V), con unidad de control

Ref.: **98-010314** (Ref. Metasys®: 104000009 / 02010314)

**3.598<sup>00</sup>€**

Hasta 5 equipos

BAJO PEDIDO



# MOTORES ASPIRACIÓN HÍBRIDA (HÚMEDA Y SECA) CENTRALIZADOS CON SEPARACIÓN AMALGAMA

Motores de aspiración híbrida METASYS® con separador de amalgama

METASYS



EXCOM Hybrid A1



EXCOM Hybrid A2



EXCOM Hybrid A5

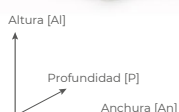

	EXCOM Hybrid A1	EXCOM Hybrid A2	EXCOM Hybrid A5
Tensión de alimentación	230 V AC	230 V AC	230 V AC / 400 V AC
Frecuencia	50 / 60 Hz	50 / 60 Hz	50 / 60 Hz
Consumo máx. corriente	6,7 A	6,7 A	9,0 / 10,0 A // 4,3 / 4,4 A
Consumo máx. potencia	0,94 / 1,1 kW	1,1 / 1,3 kW	1,5 / 1,75 kW
Temperatura máx. ambiente	40° C	40° C	40° C
Volumen aspiración	1.100 / 1.300 l/min	1.450 / 1.750 l/min	2.000 / 2.400 l/min
Zona presión negativa regulada	180 mbar	180 mbar	180 mbar
Nivel sonoro	57 / 62 dB (A)	58 / 63 dB (A)	64 / 68 dB (A)
Dimensiones (Al x An x P) en mm	570 x 422 x 400	580 x 450 x 400	620 x 460 x 455
Peso	24,5 kg	29,5 kg	35 kg
Duración conexión	100%	100%	100%
Tasa separación	99,30%	99,30%	99,30%
Número de equipos	Hasta 2 equipos	Hasta 3 equipos	Hasta 5 equipos
Suministro incluye	Kit básico instalación*	Kit básico instalación*	Kit básico instalación*
Garantía	36 meses**	36 meses**	36 meses**

\* Incluye: 1m tubo deshaogo, 1m tubo entrada, kit básico de adaptadores para la instalación + kit instalación separador de amalgama

\*\* Mínimo de mantenimiento requerido. **Consultar**

Descripción	Observaciones
<b>Opcional EXCOM Hybrid 1S + Separador de amalgama ECO II</b> Ref.: <b>98-010154 + 98-010004</b>	1 equipo
EXCOM Hybrid A1-ECO II, con unidad de control Ref.: <b>98-010251</b> (Ref. Metasys®: 104000011 / 02010251)	Hasta 2 equipos <b>2.380<sup>00</sup>€</b>
EXCOM Hybrid A2-ECO II, con unidad de control Ref.: <b>98-010221</b> (Ref. Metasys®: 104000012 / 02010221)	Hasta 3 equipos <b>2.980<sup>00</sup>€</b>
EXCOM Hybrid A5 (230 V) – ECO II TANDEM, con unidad de control Ref.: <b>98-010222</b> (Ref. Metasys®: 104000014 / 02010222)	Hasta 5 equipos <b>4.658<sup>00</sup>€</b> <span style="background-color: #4CAF50; color: white; padding: 2px;">BAJO PEDIDO</span>
EXCOM Hybrid A5 (400 V) – ECO II TANDEM, con unidad de control Ref.: <b>98-010224</b> (Ref. Metasys®: 104000015 / 02010224)	Hasta 5 equipos <b>4.728<sup>00</sup>€</b> <span style="background-color: #4CAF50; color: white; padding: 2px;">BAJO PEDIDO</span>

SI NO ENCUENTRAS EL REPUESTO QUE BUSCAS, ¡CONSÚLTANOS!  
Precios: impuestos, portes y mano de obra no incluidos.

# CUBIERTAS INSONORIZADORAS MOTORES ASPIRACIÓN METASYS®

Cubiertas insonorizadoras METASYS®

METASYS

Reduce el  
**nivel sonoro**  
un **15%**



## Descripción

Cubierta insonorizadora para EXCOM Hybrid 1s - sin ventilador

Ref.: **98-110007** (Ref. Metasys®: 120000518 / 40030007)

**375<sup>00</sup>€**

## Observaciones

Reducción nivel sonoro 15%

BAJO PEDIDO

Cubierta insonorizadora para EXCOM Hybrid 1, 2, 5, A1, A2 y A5 - con ventilador

Ref.: **98-110004** (Ref. Metasys®: 120000521 / 40030004)

**1.245<sup>00</sup>€**

Reducción nivel sonoro 15%

BAJO PEDIDO

# SEPARADOR DE AMALGAMA

Separador de amalgama METASYS®

METASYS



ECO II

ECO II  
TANDEM



	ECO II	ECO II TANDEM
Caudal máx. agua	1 l/min	2 l/min
Tasa separación	99,30%	99,30%
Volumen recipiente colector	700 cm <sup>3</sup>	2 x 700 cm <sup>3</sup>
Intervalo de cambio	Anual / lleno 100%	Anual / lleno 100%
Dimensiones (Al x An x P) en mm	308 x 164 x 201 mm	371 x 407 x 243 mm
Peso en vacío con soporte / contenedor lleno	1,7 kg / 2,7 kg	3,6 kg / 2x2,7 kg
Suministro incluye	Kit básico instalación	Kit básico instalación

Desde el 1 de enero de 2019 los operadores de los gabinetes dentales que utilicen amalgama dental, que retiren empastes de amalgama dental, o extraigan dientes que contengan dichas amalgamas, **deben contar con separadores de amalgama** (deben garantizar un nivel de retención de, como mínimo, el 95 % de las partículas de amalgama) para retener y recoger las partículas de las mismas, incluidas las contenidas en el agua usada.

## Descripción

ECO II

Ref.: **98-010004** (Ref. Metasys®: 101000015 / 01050004)

**798<sup>00</sup>€**

## Observaciones

\*Tras agotar - **ECO II PLUS**

HASTA AGOTAR

ECO II TANDEM

Ref.: **98-010007** (Ref. Metasys®: 101000018 / 01050007)

**1.380<sup>00</sup>€**

\*Tras agotar - **ECO II PLUS**

HASTA AGOTAR

# CENTRIFUGADORAS METASYS®

Centrifugadoras METASYS®



MST 1 ECO LIGHT



MST 1



COMPACT Dynamic

MST 1  
(Modelo externo)

	MST 1 ECO LIGHT	MST 1	COMPACT Dynamic
Separación de amalgama	No	Si	Si
Sistema de Autolimpieza	-	Si	Si
Tensión de alimentación	24 V AC	24 V AC	24 V AC
Frecuencia	50 / 60 Hz	50 / 60 Hz	50 / 60 Hz
Consumo máx. corriente	1,5 A	2 A	6,3 A
Consumo máx. potencia	46 VA	46 VA	100 VA
Caudal máx. agua	4,5 l/min	4,5 l/min	4,5 l/min
- desde escupidera	3,0 l/min	3,0 l/min	3,0 l/min
- desde línea de aspiración	1,5 l/min	1,5 l/min	1,5 l/min
Zona presión negativa regulada	50-250 mbar	80-250 mbar	80-160 mbar
Tasa separación	-	98,6%	96,4%
Volumen recipiente colector	300 cm <sup>3</sup>	300 cm <sup>3</sup>	300 cm <sup>3</sup>
Dimensiones (Al x An x P) en mm	305 x 163 x 104mm	305 x 210 x 104mm	301 x 173 x 110mm
Suministro incluye	Kit básico instalación	Kit básico instalación	Kit básico instalación
<b>Garantía</b>	36 meses*	36 meses*	36 meses*

\*Mínimo de mantenimiento requerido. **Consultar**

## Descripción

## Observaciones

MST 1 ECO LIGHT **sin separador de amalgama**
**Ref.: 98-010033** (Ref. Metasys®: 13000001 / 01010033)

**878<sup>00</sup>€**
MST 1 **con separador de amalgama**
**Ref.: 98-010001** (Ref. Metasys®: 101000001 / 01010001)

**2.098<sup>00</sup>€**
MST 1 **con separador de amalgama**
**Ref.: 98-010020** (Ref. Metasys®: 101000007 / 01010020)

**2.348<sup>00</sup>€**

Modelo externo

**BAJO PEDIDO**
COMPACT Dynamic **con separador de amalgama**
**Ref.: 98-110001** (Ref. Metasys®: 101000026 / 01060001)

**2.098<sup>00</sup>€**

# MANTENIMIENTO, REPUESTOS Y ACCESORIOS

## Válvulas



### Válvula escupidera

### Válvulas selectoras

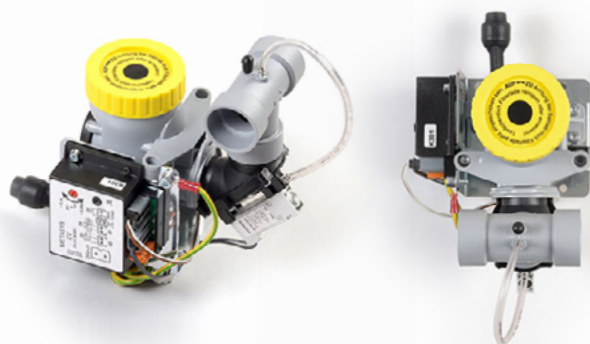

	Descripción	Observaciones
	Válvula escupidera <b>24 V DC / AC</b>  <b>Ref.: 98-020002</b> (Ref. Metasys®: 110000002 / 40050002)	<b>Garantía:</b> 12 meses  <b>489<sup>80</sup>€</b>
	Filtro cesta Metasys MST1, A8 y escupidera  <b>Ref.: 98-030002F</b> (Ref. Metasys®: 120000212 / 55010002)	<b>Pack:</b> 10 unidades  <b>109<sup>80</sup>€</b>
	Válvula selectora <b>24 DC / CC</b>  <b>Ref.: 98-020048</b> (Ref. Metasys®: 110000004 / 40050048)	<b>113<sup>80</sup>€</b>
	Válvula selectora <b>24 DC / CC y 24 AC / CA*</b>  <b>Ref.: 98-020044</b> (Ref. Metasys®: 110000005 / 40050044)	*98-020044 = 98-020048 + complemento que la hace AC / CA. (El complemento se puede utilizar o no).  <b>151<sup>80</sup>€</b>
	Membrana válvula selectora Metasys  <b>Ref.: 98-010003</b>	<b>11<sup>80</sup>€</b>

# REPUESTOS MOTORES ASPIRACIÓN

## Repuestos motores aspiración



	Descripción	Observaciones
	Aspa y tapa superior (Centrifuga) Motores METASYS® EXCOM Hybrid 1, 2, 5, A1, A2 y A5 <b>Ref.: 98-010210</b> (Ref. Metasys®: 120000625 / 50060210 + aspa)	<b>618<sup>00</sup>€</b>
	Filtro entrada motores METASYS EXCOM Hybrid <b>Ref.: 98-010467</b> (Ref. Metasys®: 120000467 / 55010010)	<b>72<sup>80</sup>€</b>

NUEVO



Imagen no disponible

# KITS MANTENIMIENTO MOTORES ASPIRACIÓN

## Kits mantenimiento motores aspiración



	Descripción	Observaciones
	Kit mantenimiento anual motores METASYS EXCOM Hybrid 1, 2, A1 y A2 <b>Ref.: 98-010240</b> (Ref. Metasys®: 120000527 / 50060240)	<b>164<sup>80</sup>€</b> <b>Incluye:</b> Colector de agua con válvula antiretorno, conexión adaptador para separación y tubo PVC

# KITS MANTENIMIENTO CENTRIFUGADORAS

## Kits mantenimiento centrifugadoras





	Descripción	Observaciones
	Kit inspección anual centrifugadora MST 1 <b>Ref.: 98-010109</b> (Ref. Metasys®: 120000235 / 50020109)	<b>164<sup>80</sup>€</b>
	Kit inspección 5 años centrifugadora MST 1 <b>Ref.: 98-010110</b> (Ref. Metasys®: 120000229 / 50020110)	<b>446<sup>80</sup>€</b> <b>Incluye:</b> Cuerpo básico de entrada con válvula antiretorno integrada, membrana válvula selectora, filtro bomba, contenedor reemplazo, cajón de filtro, tapa centrifugadora, anillo desplazamiento agua, deflector de aire, cámara de centrifugado y tapa bomba centrifugado. <b>BAJO PEDIDO</b>
	Kit inspección anual centrifugadora COMPACT Dynamic y COMPACT Dynamic ECO <b>Ref.: 98-010030</b> (Ref. Metasys®: 120000598 / 50040030)	<b>283<sup>80</sup>€</b> <b>Incluye:</b> Rotor completo, junta, parte superior separador con membrana y contenedor reemplazo.
	Kit inspección 5 años centrifugadora COMPACT Dynamic <b>Ref.: 98-010031</b> (Ref. Metasys®: 120000594 / 50040031)	<b>366<sup>80</sup>€</b> <b>Incluye:</b> Rotor completo, junta, parte superior separador con membrana y contenedor reemplazo + centrifugadora y filtro bomba. <b>BAJO PEDIDO</b>
	Kit inspección anual centrifugadora MST 1 ECO Light <b>Ref.: 98-010119</b> (Ref. Metasys®: 120000249 / 50020119)	<b>133<sup>80</sup>€</b> <b>Incluye:</b> Anillo desplazamiento agua, deflector aire, alojamiento entrada bomba, membrana, válvula antiretorno, anillo tórico.

## CONTENEDORES SEPARADORES DE AMALGAMA

### Contenedores separadores de amalgama





	Descripción	Observaciones
	Contenedor reemplazo MST 1 <b>Ref.: 98-210001</b> (Ref. Metasys®: 113000054 / 55020001) <b>47´80€</b>	
	Contenedor reemplazo COMPACT Dynamic <b>Ref.: 98-010005</b> (Ref. Metasys®: 113000013 / 55020005) <b>45´80€</b>	
	Contenedor reemplazo ECO II+, ECO II y ECO II Tandem <b>Ref.: 98-010130</b> (Ref. Metasys®: 113000077) <b>296´80€</b>	Sustituye al antiguo modelo (Ref. Metasys®: 113000034 / 55020130)

## TUBO ENTRADA ASPIRACIONES

### Tubo entrada aspiraciones





	Descripción	Observaciones
	Tubo de entrada de aire de sistemas de aspiración <b>Ref.: 98-020050</b> (Ref. Metasys®: 120000106 / 40300050) <b>42´80€</b>	<b>Diámetro:</b> 40mm <b>BAJO PEDIDO</b> <b>Por metro</b> Compra mínima 1 metro referencia Múltiplos de 1m, NO fracciones)
	Tubo de entrada de aire de sistemas de aspiración <b>Ref.: 98-020051</b> (Ref. Metasys®: 120000105 / 40300051) <b>45´80€</b>	<b>Diámetro:</b> 50mm <b>Por metro</b> Compra mínima 1 metro referencia Múltiplos de 1m, NO fracciones)

## TUBO DESAHOGO ASPIRACIONES

### Tubo desahogo aspiraciones



	Descripción	Observaciones
	Tubo <b>termo resistente</b> para descarga / desahogo de aire de sistemas de aspiración <b>Ref.: 98-020100</b> (Ref. Metasys®: 120000109 / 40300100) <b>76´80€</b>	<b>Diámetro:</b> 32mm <b>Por metro</b> Compra mínima 1 metro referencia Múltiplos de 1m, NO fracciones) Máximo 4m por tramo
	Tubo <b>termo resistente</b> para descarga / desahogo de aire de sistemas de aspiración <b>Ref.: 98-020101</b> (Ref. Metasys®: 120000108 / 40300101) <b>80´80€</b>	<b>Diámetro:</b> 40mm <b>Por metro</b> Compra mínima 1 metro referencia Múltiplos de 1m, NO fracciones) Máximo 4m por tramo
	Tubo <b>termo resistente</b> para descarga / desahogo de aire de sistemas de aspiración <b>Ref.: 98-020102</b> (Ref. Metasys®: 120000107 / 40300102) <b>88´00€</b>	<b>Diámetro:</b> 50mm <b>Por metro</b> Compra mínima 1 metro referencia Múltiplos de 1m, NO fracciones) Máximo 4m por tramo

# FILTROS SALIDA ASPIRACIONES HEPA H14

## Filtros salida aspiraciones HEPA H14

RUMAR

- Filtro **HEPA** (High Efficiency Particulate Air) con nivel de filtración H14 (99,995%)
- Adaptable a todos los sistemas de aspiración dental, fácil de instalar y mantener
- Apto para **hasta 5 sillones dentales** (144 m<sup>3</sup>/h)
- Instalable al final o en la línea de la salida de aire
- Frecuencia de **cambio de cartucho recomendada**: 24 meses
- Material: microfibra HEPA H14

**- Suministro incluye:**

- Filtro con cartucho
- Tubo desahogo termoresistente (80cm aprox.) Ø40mm
- Espigas PVC: 2uds. 1,0" x Ø30mm
- 2uds. 1 1/4" x Ø40mm
- Adaptadores PVC: 2uds. 1 1/4" x 1,0"
- Abrazaderas metálicas: 2uds. para Ø30mm
- 2uds. para Ø40mm





Filtra el **99,99%** de la materia fina suspendida



Separación Flujo nominal de aire (m <sup>3</sup> /h)	ENTRADA A	SALIDA B	ENTRADA A (mm)	SALIDA B (mm)	C (mm)	D (mm)	Øe (mm)	H (mm)	PESO (Kg)
144	G1 1/2 "	G1 1/2 "	38	38	95	98	173	156	1,7

**Descripción**

**Observaciones**

	<p>Filtro salida aspiraciones HEPA H14 completo</p> <p>Ref.: <b>98-030011</b></p> <p><b>398'00€</b></p>	
	<p>Cartucho interno repuesto filtro salida aspiraciones HEPA H14</p> <p>Ref.: <b>98-030011C</b></p> <p><b>184'80€</b></p>	

# CONECTORES META CONNECT - DÜRR CONNECT

## Conectores Meta Connect



	Descripción	Observaciones
	Adaptador Dürr® Connect <b>(G)</b> - META Connect <b>Ref.: 98-040124</b> (Ref. Metasys®: 120000084 / 40010124)	<b>Macho - Macho</b> 1 unidad <b>15'80€</b>
	Adaptador Dürr® Connect <b>(K)</b> - META Connect <b>Ref.: 98-040084</b> (Ref. Metasys®: 120000285 / 40010084)	<b>Macho - Macho</b> 1 unidad <b>15'80€</b>
	Adaptador Dürr® Connect <b>(K)</b> - META Connect <b>Ref.: 98-040102</b> (Ref. Metasys®: 120000286 / 40010102)	<b>Hembra - Hembra</b> 1 unidad <b>15'80€</b>
	Adaptador conexión Ø Interno 27mm X Ø Exterior 32mm - META Connect <b>Ref.: 98-040125</b> (Ref. Metasys®: 120000087 / 40010125)	<b>Macho - Macho</b> 1 unidad <b>14'80€</b>
	Clip cierre META Connect <b>Ref.: 98-040103</b> (Ref. Metasys®: 120000274 / 40010103)	1 unidad <b>11'80€</b>



# LIMPIEZA ASPIRACIONES

Limpiador, desinfectante y desodorizante GREEN & CLEAN®

**METASYS**

Doble concentrado desespumado activo para la limpieza diaria, desinfección y desodorización de sistemas de aspiración y separadores de amalgama.

- Apto para el mantenimiento de aspiraciones de **todas las marcas**.
- Concentrado: fácil de transportar y no ocupa espacio.
- Sistema dual especialmente diseñado para impedir la generación de microorganismos resistentes.
- Extremadamente **cómodo** y **sencillo**.

Apto para el mantenimiento de  
**TODAS LAS MARCAS**



## Modo de empleo

<ol style="list-style-type: none"> <li>1. Accionar dos veces la bomba dosificadora (= 6 ml de concentrado)</li> <li>2. Llenar el recipiente con agua hasta la marca (= 600 ml solución al 1%)</li> <li>3. Colocar la cánula pequeña en el orificio marcado con 1 hasta que se aspire aire (200 ml)</li> </ol>	<ol style="list-style-type: none"> <li>4. Colocar la cánula grande en el orificio marcado con 2 hasta que se aspire aire (200 ml)</li> <li>5. Vaciar el líquido restante en la taza de la escupidera (200 ml)</li> <li>6. Esperar el tiempo de actuación y luego enjuagar (60 min para HBV/HIV/HCV, tuberculida)</li> </ol>				

	Descripción	Observaciones
	Kit iniciación Green & Clean® M2 <b>Ref.: 98-030201</b> (Ref. Metasys®: 122000026 / 60010201)	<b>Incluye:</b> 1 x dispensador 1 x M2 rojo 500ml 1 x M2 verde 500ml Aproximadamente <b>167 aplicaciones</b>
	Kit refill I Green & Clean® M2 <b>Ref.: 98-030202</b> (Ref. Metasys®: 122000027 / 60010202)	<b>Incluye:</b> 2 x M2 rojo 500ml 2 x M2 verde 500ml Aproximadamente <b>334 aplicaciones</b>
	Kit refill II Green & Clean® M2 <b>Ref.: 98-030203</b> (Ref. Metasys®: 122000028 / 60010203)	<b>Incluye:</b> 1 x M2 rojo 500ml 1 x M2 verde 500ml Aproximadamente <b>167 aplicaciones</b>

## LIMPIEZA BIOFILM SILLONES

### Limpiador Biofilm líneas agua sillones



MÁS BAJO

- Diseñado para que al menos una vez al año el servicio técnico haga una limpieza integral de las líneas de agua limpia de los sillones dentales.
- Muy sencillo de utilizar por servicios técnicos.
- Unos pocos sencillos pasos, y una hora de actuación, para que toda la red de tubos de agua limpia del sillón dental, quede completamente pulcra.

Evite obstrucciones en el sillón y en los instrumentos.  
¡Sorprendentes resultados!



	Descripción	Observaciones
	Bomba para BR + 1 botella limpiador BR 1.000ml <b>Ref.: 98-030501</b> (Ref. Metasys®: 108000034 / 40050501)	<b>478´00€</b>
	2 botellas limpiador BR <b>Ref.: 98-030300</b> (Ref. Metasys®: 122000002 / 60040300)	<b>89´80€</b> <b>Pack:</b> 2 unidades <b>Contenido:</b> 1 litro/ud

## MANTENIMIENTO ASPIRACIONES

### Mantenimiento aspiraciones







	Descripción	Observaciones
	Limpiador especial de sistemas aspiración DÜRR® MD-555 - Concentrado sin espuma para instalaciones dentales de aspiración y desagüe. - Complemento idóneo para Orotol Plus para el cuidado completo y perfecta limpieza y mantenimiento de instalaciones de aspiración de todo tipo. <b>Ref.: 68-37003</b>	1 unidad <b>Contenido:</b> 2,5 litros <b>58´80€</b>
<b>NUEVO</b> 	Filtro sólidos aspiraciones Cattani® <b>***Original Cattani***</b> <b>Ref.: 38-1055</b> (Ref. Cattani®: 1041055   Ref. Fedesa®: F034A91)	<b>Pack:</b> 12 unidades Utilizado en la mayoría de unidades Fedesa entre otros. <b>15´20€</b>
<b>NUEVO</b> 	Porta filtros rectangular gris 2 terminales <b>***Original Cattani***</b> <b>Ref.: 38-0854</b> (Ref. Cattani®: 200854)	(Ref. Fedesa®: 2403A03 + 034A91 + 710A12 + 2406A01) <b>48´00€</b>
	Filtro amarillo aspiraciones Dürr® <b>***Original Dürr***</b> <b>Ref.: 68-37001</b> (Ref. Dürr®: 0725.041.00)	<b>Pack:</b> 1 ud. Utilizado en algunas unidades Fedesa entre otros. <b>38´80€</b>
	Filtro amarillo dos entradas Dürr Connect <b>Ref.: 68-37005</b> (Ref. Dürr®: 0700.705.54)	**Adaptadores a manguera de 11mm y 17mm. <b>108´00€</b> <b>Consultar Refs.:</b> 38-011T y 38-017T

## VÁLVULAS DÜRR®

### Válvulas Dürr®





	Descripción	Observaciones
	Válvula antiretorno CAS-1, CSI y compatibles <b>Ref.: 68-26001</b> (Ref. Dürr®: 7117.420.43 - 1ud. de 2)	1 unidad <b>51<sup>80</sup>€</b>
	Retén CAS-1 <b>Ref.: 68-26002</b> (Ref. Dürr®: 7128.100.03)	1 unidad <b>27<sup>80</sup>€</b> <span style="background-color: yellow;">HASTA AGOTAR</span>
	Válvula centralizadora / selectora aspiración <b>Ref.: 68-36001</b> (Ref. Dürr®: 7560.500.60E)	<b>180<sup>00</sup>€</b>
	Membrana válvula centralizadora / selectora aspiración <b>Ref.: 68-36002</b> (Ref. Dürr®: 7560.500.22)	<b>17<sup>80</sup>€</b>
	Válvula antiretorno Dürr Connect <b>Ref.: 68-36005</b> (Ref. Dürr®: 7128.100.03)	<b>19<sup>80</sup>€</b>

## REPUESTOS ASPIRACIONES DÜRR®

### Repuestos aspiraciones Dürr®









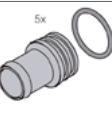
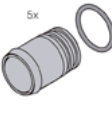

	Descripción	Observaciones
	Aspa / Turbina V300S y VS300S <b>Ref.: 68-25001</b> (Ref. Dürr®: 7119.983.054   Antigua 7119.933.55)	<b>234<sup>80</sup>€</b>
	Aspa / Turbina V600 y VS600 <b>Ref.: 68-25002</b> (Ref. Dürr®: 7127.983.55)	<b>302<sup>80</sup>€</b>
	Aspa / Turbina VSA300S <b>Ref.: 68-25005</b> (Ref. Dürr®: R7110.115.00E)	<b>88<sup>00</sup>€</b>
 <small>Imagen no disponible</small>	Junta tórica desagüe VS-300 <b>Ref.: 68-25006</b> (Ref. Dürr®: R9000.402.23)	<b>9<sup>80</sup>€</b>
 <small>Imagen no disponible</small>	Unión desagüe VS-300, VS-600, VS-900 y compatibles <b>Ref.: 68-25007</b> (Ref. Dürr®: 7128.100.02)	<b>14<sup>20</sup>€</b>
	Tapa + ventilador V300S, VS300S, V600, VS600, V900S y VS900S <b>Ref.: 68-25003</b> (Ref. Dürr®: 7130.982.54)	<b>101<sup>80</sup>€</b>

	Descripción	Observaciones
	Biofiltro HEPA H13 V300, VS300 y VSA 300S <b>Ref.: 68-25004</b> (Ref. Dürr®: R7119100010) <b>138'00€</b>	
	Kit mantenimiento CS-1 <b>Ref.: 68-26003</b> (Ref. Dürr®: 7117.980.33) <b>119'80€</b>	

## CONECTORES DÜRR® CONNECT

### DÜRR® Connect K (20mm)





	Descripción	Observaciones
	Dürr Connect hembra a 15mm (K) <b>Ref.: 68-87004</b> (Ref. Dürr®: 0700.720.15E) <b>18'80€</b>	<b>Pack:</b> 5 unidades
	Dürr Connect macho a 20mm (K) <b>Ref.: 68-87003</b> (Ref. Dürr®: 0700.710.20E) <b>18'80€</b>	<b>Pack:</b> 5 unidades
	Dürr Connect macho a 25mm (K) <b>Ref.: 68-87020</b> (Ref. Dürr®: 0700.710.25E) <b>18'80€</b>	<b>Pack:</b> 5 unidades
	Dürr Connect "T" 2 x macho / 1 x hembra, c/sifón (K) <b>Ref.: 68-87021</b> (Ref. Dürr®: 0700.700.08E) <b>33'80€</b>	<b>Pack:</b> 3 unidades
	Dürr Connect macho-macho (K) <b>Ref.: 68-87014</b> (Ref. Dürr®: 0700.700.13E) <b>18'80€</b>	<b>Pack:</b> 5 unidades
	Dürr Connect hembra a 17mm (K) <b>Ref.: 68-87005</b> (Ref. Dürr®: 0700.720.17E) <b>18'80€</b>	<b>Pack:</b> 5 unidades
	Dürr Connect hembra a 18mm (K) <b>Ref.: 68-87007</b> (Ref. Dürr®: 0700.720.18E) <b>18'80€</b>	<b>Pack:</b> 5 unidades
	Dürr Connect hembra a 20mm (K) <b>Ref.: 68-87017</b> (Ref. Dürr®: 0700.720.20E) <b>18'80€</b>	<b>Pack:</b> 5 unidades
	Dürr Connect hembra a 22mm (K) <b>Ref.: 68-87019</b> (Ref. Dürr®: 0700.720.22E) <b>18'80€</b>	<b>Pack:</b> 5 unidades
	Dürr Connect hembra a 25mm (K) <b>Ref.: 68-87006</b> (Ref. Dürr®: 0700.720.25E) <b>18'80€</b>	<b>Pack:</b> 5 unidades

	Descripción	Observaciones
	Dürr® Connect hembra a 30mm (K) <b>Ref.: 68-87009</b> (Ref. Dürr®: 0700.720.30E) <b>18'80€</b>	<b>Pack:</b> 3 unidades
	Dürr® Connect hembra 36mm (K) <b>Ref.: 68-87008</b> (Ref. Dürr®: 0700.700.21E) <b>18'80€</b>	<b>Pack:</b> 5 unidades
	Dürr® Connect hembra-hembra (K) <b>Ref.: 68-87013</b> (Ref. Dürr®: 0700.700.11E) <b>18'80€</b>	<b>Pack:</b> 5 unidades
	Dürr® Connect manguito a 32mm (K) <b>Ref.: 68-87018</b> (Ref. Dürr®: 0700.700.20E) <b>18'80€</b>	<b>Pack:</b> 5 unidades
	Dürr® Connect codo 90° (K) <b>Ref.: 68-87015</b> (Ref. Dürr®: 0700.700.04E) <b>18'80€</b>	<b>Pack:</b> 5 unidades
	Dürr® Connect tapón sencillo (K) <b>Ref.: 68-87010</b> (Ref. Dürr®: 0700.700.10E) <b>18'80€</b>	<b>Pack:</b> 5 unidades
	Dürr® Connect "T" 1 x macho / 2 x hembra (K) <b>Ref.: 68-87012</b> (Ref. Dürr®: 0700.700.06E) <b>33'80€</b>	<b>Pack:</b> 3 unidades
	Dürr® Connect "T", 3 x macho (K) <b>Ref.: 68-87002</b> (Ref. Dürr®: 0700.700.02E) <b>18'80€</b>	<b>Pack:</b> 5 unidades
	Dürr® Connect "Y", 3 x macho (K) <b>Ref.: 68-87001</b> (Ref. Dürr®: 0700.700.03E) <b>18'80€</b>	<b>Pack:</b> 5 unidades
	Dürr® Connect clip pequeño (K) <b>Ref.: 68-87011</b> (Ref. Dürr®: 0700.700.01E) <b>18'80€</b>	<b>Pack:</b> 20 unidades
	Dürr® Connect anillo tórico (K) <b>Ref.: 68-87016</b> (Ref. Dürr®: 9000.402.54) <b>2'95€</b>	1 unidad

## DÜRR® Connect G (32mm)





	Descripción	Observaciones
	Dürr® Connect clip grande (G) <b>Ref.: 68-88004</b> (Ref. Dürr®: 0700.800.01E) <b>32'80€</b>	<b>Pack:</b> 20 unidades
	Dürr® Connect codo 90° (G) <b>Ref.: 68-88005</b> (Ref. Dürr®: 0700.800.04E) <b>48'00€</b>	<b>Pack:</b> 3 unidades

	Descripción	Observaciones
	Dürr® Connect hembra a 30mm (G) Ref.: <b>68-88003</b> (Ref. Dürr®: 0700.820.30E)	Pack: 3 unidades 31'80€
	Dürr® Connect macho a 30mm (G) Ref.: <b>68-88001</b> (Ref. Dürr®: 0700.810.30E)	Pack: 3 unidades 31'80€
	Dürr® Connect macho-macho (G) Ref.: <b>68-88002</b> (Ref. Dürr®: 0700.800.13E)	Pack: 3 unidades 25'80€



## MANGUERA ASPIRACIÓN EVA EXTRAFLEXIBLE

- Máxima calidad y durabilidad.
- Manguera extra flexible de Etyl-Vinilo-Acetato.
- Corrugada interior y exterior.
- Resistente a todos los desinfectantes homologados.
- Color: gris claro RAL 7035.
- **Diseño especial equipos CEFLA (Stern Weber®, Castellini® y Anthos®).**



	Descripción	Observaciones
	Manguera aspiración EVA extraflexible. Ø interno: 11mm Ref.: <b>36-611R</b>	Longitud: 25 metros Incluye: Adoptadores silicona 174'80€
	Manguera aspiración EVA extraflexible. Ø interno: 11mm Ref.: <b>36-611M</b>	Longitud: a medida, <b>METROS ENTEROS, NO FRACCIÓN</b> Incluye: Adoptadores silicona NO ADMITEN DEVOLUCIÓN 9'20€

11mm

	Descripción	Observaciones
	Manguera aspiración EVA extraflexible. Ø interno: 17mm Ref.: <b>36-617R</b>	Longitud: 25 metros 205'80€
	Manguera aspiración EVA extraflexible. Ø interno: 17mm Ref.: <b>36-617M</b>	Longitud: a medida <b>METROS ENTEROS, NO FRACCIÓN</b> NO ADMITEN DEVOLUCIÓN 10'20€

17mm

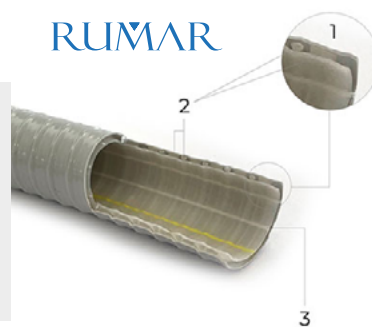

# MANGUERA ASPIRACIÓN PVC PREMIUM

RUMAR

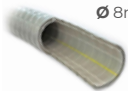
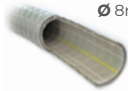
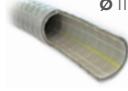
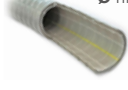
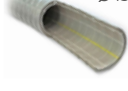
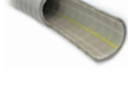
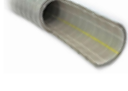
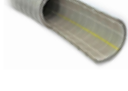

- **Calidad Premium**
- Máxima ligereza, flexibilidad y durabilidad.
- Resistente a todos los desinfectantes homologados.
- Color gris claro RAL 7035.

1. Doble capa de PVC flexible diseñada para una mayor durabilidad sin perder ligereza o flexibilidad.
2. Doble hélice de Polipropileno alrededor del eje para mayor durabilidad.
3. Hilos longitudinales para aumentar la integridad de la manguera.

	Descripción	Observaciones
	Manguera aspiración PVC <b>PREMIUM</b> Ø interno: 8mm Ref.: <b>36-808R</b>	Longitud: 25 metros 568 <sup>00</sup> €
	Manguera aspiración PVC <b>PREMIUM</b> Ø interno: 8mm Ref.: <b>36-808M</b>	Longitud: a medida METROS ENTEROS, NO FRACCIÓN NO ADMITEN DEVOLUCIÓN (< 10metros) 26 <sup>80</sup> € (>= 10metros) 24 <sup>80</sup> €
	Manguera aspiración PVC <b>PREMIUM</b> Ø interno: 11mm Ref.: <b>36-811R</b>	Longitud: 25 metros 448 <sup>00</sup> €
	Manguera aspiración PVC <b>PREMIUM</b> Ø interno: 11mm Ref.: <b>36-811M</b>	Longitud: a medida METROS ENTEROS, NO FRACCIÓN NO ADMITEN DEVOLUCIÓN (< 10metros) 19 <sup>80</sup> € (>= 10metros) 21 <sup>80</sup> €
	Manguera aspiración PVC <b>PREMIUM</b> Ø interno: 15mm Ref.: <b>36-815R</b>	Longitud: 25 metros 568 <sup>00</sup> €
	Manguera aspiración PVC <b>PREMIUM</b> Ø interno: 15mm Ref.: <b>36-815M</b>	Longitud: a medida METROS ENTEROS, NO FRACCIÓN NO ADMITEN DEVOLUCIÓN (< 10metros) 25 <sup>80</sup> € (>= 10metros) 28 <sup>00</sup> €
	Manguera aspiración PVC <b>PREMIUM</b> Ø interno: 17mm Ref.: <b>36-817R</b>	Longitud: 25 metros 498 <sup>00</sup> €
	Manguera aspiración PVC <b>ECO PREMIUM</b> Ø interno: 17mm Ref.: <b>36-817M</b>	Longitud: a medida METROS ENTEROS, NO FRACCIÓN NO ADMITEN DEVOLUCIÓN (< 10metros) 21 <sup>80</sup> € (>= 10metros) 22 <sup>80</sup> €
	Manguera aspiración PVC <b>PREMIUM</b> Ø interno: 20mm Ref.: <b>36-820R</b>	Longitud: 25 metros 698 <sup>00</sup> €
	Manguera aspiración PVC <b>PREMIUM</b> Ø interno: 20mm Ref.: <b>36-820M</b>	Longitud: a medida METROS ENTEROS, NO FRACCIÓN NO ADMITEN DEVOLUCIÓN (< 10metros) 30 <sup>80</sup> € (>= 10metros) 33 <sup>80</sup> €

8mm

11mm

15mm

17mm

20mm











## MANGUERA ASPIRACIÓN PVC FLEXIBLE ECO

RUMAR

- Doble pared reforzada de PVC flexible.
- Buena flexibilidad.

- Resistente a todos los desinfectantes homologados.
- Color gris claro RAL 7035.



	Descripción	Observaciones	
	Manguera aspiración PVC ECO. Ø interno: 8mm <b>Ref.: 36-008</b>	Longitud: 160cm	8 mm
	Manguera aspiración PVC ECO. Ø interno: 11mm <b>Ref.: 36-011R</b>	Longitud: 12 metros	11 mm
	Manguera aspiración PVC ECO. Ø interno: 11mm <b>Ref.: 36-011M</b>	Longitud: a medida <b>METROS ENTEROS, NO FRACCIÓN NO ADMITEN DEVOLUCIÓN</b>	
	Manguera aspiración PVC ECO. Ø interno: 11mm <b>Ref.: 36-011</b>	Longitud: 160cm	
	Manguera aspiración PVC ECO <b>con terminal</b> . Ø interno: 11mm <b>Ref.: 36-111</b>	Longitud: 160cm Incluye: Terminal	
	Manguera aspiración PVC ECO. Ø interno: 15mm <b>Ref.: 36-015</b>	Longitud: 160cm	15 mm
	Manguera aspiración PVC ECO. Ø interno: 17mm <b>Ref.: 36-017R</b>	Longitud: 12 metros	17 mm
	Manguera aspiración PVC ECO. Ø interno: 17mm <b>Ref.: 36-017M</b>	Longitud: a medida <b>METROS ENTEROS, NO FRACCIÓN NO ADMITEN DEVOLUCIÓN</b>	
	Manguera aspiración PVC ECO. Ø interno: 17mm <b>Ref.: 36-017</b>	Longitud: 160cm	
	Manguera aspiración PVC ECO <b>con terminal</b> . Ø interno: 17mm <b>Ref.: 36-117</b>	Longitud: 160cm Incluye: Terminal	
	Manguera aspiración PVC ECO. Ø interno: 20mm <b>Ref.: 36-020</b>	Longitud: 160cm	20 mm



## TERMINALES DE ASPIRACIÓN RUMAR®

- Resistente a todos los desinfectantes homologados.

### Terminales de aspiración

RUMAR

	Descripción	Observaciones
	<b>Terminal aspiración + adaptador</b> para mangueras de 11 mm interno. <b>Ref.: 38-011T</b>	Montaje en manguera con pegamento Compatible Ref. Fedesa®: 034A37 <b>6'80€</b>
	<b>Terminal aspiración + adaptador</b> para mangueras de 17 mm interno. <b>Ref.: 38-017T</b>	Montaje en manguera con calor Compatible Ref. Fedesa®: 034A36 <b>6'80€</b>
	<b>Terminal aspiración conector</b> 6,35 - 7,00mm <b>Ref.: 38-007T</b>	<b>12'80€</b>
	Punta terminal aspiración Ref.: 46-387 <b>Ref.: 38-007TP</b>	<b>5'80€</b>
	<b>Terminal aspiración conector</b> 12,4 - 12,55mm <b>Ref.: 38-013T</b>	<b>10'80€</b>

## ADAPTADORES TERMINALES - CÁNULAS RUMAR®

- Resistentes.

- Color crema.

- Esterilizable en autoclave 135° C.

### Terminales de aspiración

RUMAR

	Descripción	Observaciones
	Adaptador terminal cánula salvador. Ø interno: 11mm interior <b>Ref.: 38-511/5</b>	<b>Pack: 5 unidades</b> <b>15'20€</b>
	Adaptador terminal cánula niebla de spray y cirugía. Ø interno: 17mm <b>Ref.: 38-517/5</b>	<b>Pack: 5 unidades</b> <b>15'20€</b>
	Adaptador aspirasaliva Cattani® N° 15. <b>***Original Cattani***</b> <b>Ref.: 38-0515</b> (Ref. Cattani®: 1040515)	1 unidad <b>7'00€</b>
	Adaptador terminal Cattani® de diámetro 16mm a diámetro 11mm <b>***Original Cattani***</b> <b>Ref.: 38-0520</b> (Ref. Cattani®: 1040520)	1 unidad Esterilizable en autoclave 135° C. <b>2'80€</b>

NUEVO

NUEVO

SI NO ENCUENTRAS EL REPUESTO QUE BUSCAS, ¡CONSÚLTANOS!  
 Precios: impuestos, portes y mano de obra no incluidos.

RUMAR 225

# TERMINALES DE ASPIRACIÓN DÜRR®

- Calidad Dürr®.
- Resistente a todos los desinfectantes homologados.

## Terminales de aspiración para manguera gruesa DÜRR®



d <sub>1</sub>	d <sub>2</sub>	Forma	Ref. Nr./No.
10,0	26,3		68-38001
17,0	26,3		68-38002
20,0	26,3		68-38003
19,0	26,3		68-38004
18,0	26,3		68-38006
18,0	26,3		68-38007

	Descripción	Observaciones
	Terminal angular, tubo grueso, gris, con pestillo desplazamiento.  <b>Ref.: 68-38017</b>	<b>32'80€</b>
	Terminal angular, tubo grueso, gris, sin pestillo desplazamiento.  <b>Ref.: 68-38018</b>	<b>18'80€</b>
	Terminal articulación gris terminal de aspiración grueso.  <b>Ref.: 68-38016</b>	<b>28'80€</b>

Terminales de aspiración para manguera fina DÜRR®

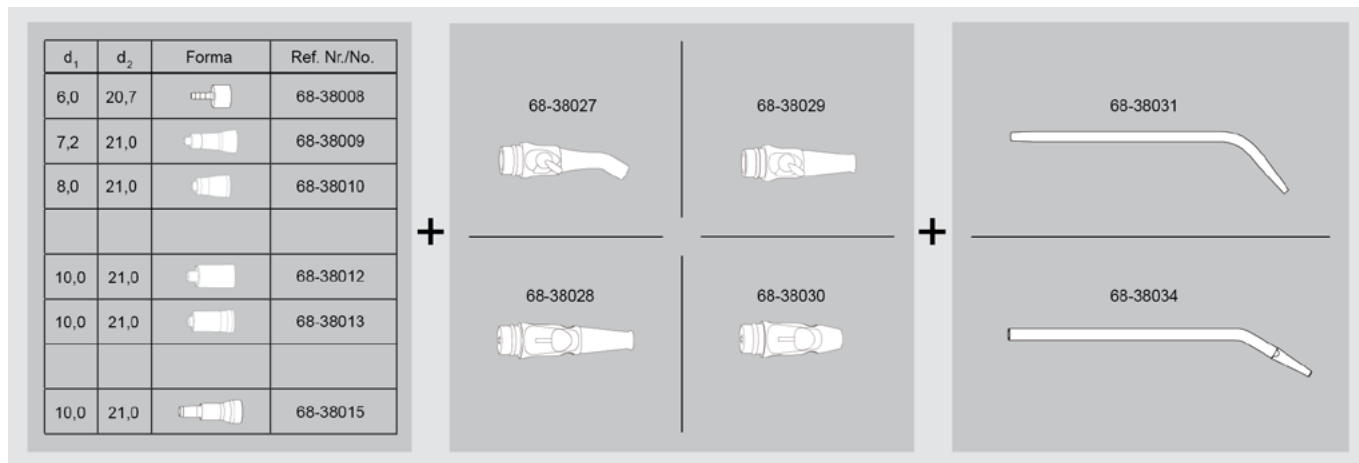

	Descripción	Observaciones
	Terminal angular, tubo fino, gris, con pestillo giratorio. <b>Ref.: 68-38027</b>	<b>31'80€</b>
	Punta terminal angular, tubo fino, gris. <b>Ref.: 68-38027P</b>	<b>38'80€</b> Pack: 3 unidades
	Terminal recto, tubo fino, gris, con pestillo deslizamiento. <b>Ref.: 68-38028</b>	<b>28'00€</b>
	Terminal recto, tubo fino, gris, con pestillo giratorio. <b>Ref.: 68-38029</b>	<b>36'80€</b>
	Terminal recto, tubo fino, gris, con pestillo deslizamiento. <b>Ref.: 68-38030</b>	<b>21'80€</b>

Adaptadores mangueras - terminales de aspiración DÜRR®







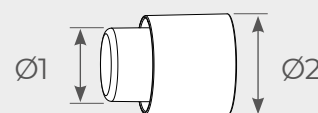

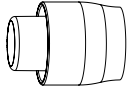
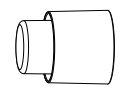
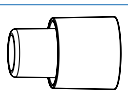

- Calidad Dürr®.
- Resistente a todos los desinfectantes homologados.

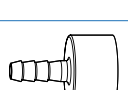
Ejemplo:

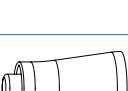

	Descripción	Observaciones
	Adaptador manguera-terminal universal 10mm. <b>Ref.: 68-38001</b>	<b>16'80€</b> Diámetro: Ø1: 10,0mm x Ø2: 26,3mm
	Adaptador manguera-terminal A-dec 17mm. <b>Ref.: 68-38002</b>	<b>17'80€</b> Diámetro: Ø1: 17,0mm x Ø2: 26,3mm





	Descripción	Observaciones
	Adaptador manguera-terminal KaVo® 20mm. <b>Ref.: 68-38003</b>	<b>Diámetro:</b> Ø1: 20,0mm x Ø2: 26,3mm <b>17'80€</b>
	Adaptador manguera-terminal Dürr® Comfort. <b>Ref.: 68-38004</b>	<b>Diámetro:</b> Ø1: 19,0mm x Ø2: 26,3mm <b>17'80€</b>
	Adaptador manguera-terminal universal 18mm. <b>Ref.: 68-38006</b>	<b>Diámetro:</b> Ø1: 18,0mm x Ø2: 26,3mm <b>17'80€</b>
	Adaptador manguera-terminal universal 18mm. <b>Ref.: 68-38007</b>	<b>Diámetro:</b> Ø1: 18,0mm x Ø2: 26,3mm <b>19'80€</b>
	Adaptador manguera-terminal universal 6mm. <b>Ref.: 68-38008</b>	<b>Diámetro:</b> Ø1: 6,0mm x Ø2: 20,7mm <b>20'80€</b>
	Adaptador manguera-terminal A-dec 7,2mm. <b>Ref.: 68-38009</b>	<b>Diámetro:</b> Ø1: 7,2mm x Ø2: 21,0mm <b>13'80€</b>
	Adaptador manguera-terminal KaVo® 8mm. <b>Ref.: 68-38010</b>	<b>Diámetro:</b> Ø1: 8,0mm x Ø2: 21,0mm <b>15'80€</b>
	Adaptador manguera-terminal Cattani® 10mm. <b>Ref.: 68-38012</b>	<b>Diámetro:</b> Ø1: 10,0mm x Ø2: 21,0mm <b>15'80€</b>
	Adaptador manguera-terminal Dürr® Comfort. <b>Ref.: 68-38013</b>	<b>Diámetro:</b> Ø1: 10,0mm x Ø2: 21,0mm <b>17'80€</b>
	Adaptador manguera-terminal universal 10mm. <b>Ref.: 68-38015</b>	<b>Diámetro:</b> Ø1: 10,0mm x Ø2: 21,0mm <b>15'80€</b>

# ADAPTADORES TERMINALES-CÁNULAS Y CÁNULAS DE ASPIRACIÓN

- Calidad Dürr®.
- Resistente a todos los desinfectantes homologados.

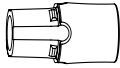
## Manguera gruesa DÜRR®

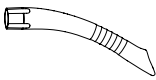

	Descripción	Observaciones
	Manguito giratorio 16mm. <b>Ref.: 68-38019</b>	<b>18<sup>80</sup>€</b>
	Manguito giratorio 16mm. <b>Ref.: 68-38020</b>	<b>7<sup>30</sup>€</b>
	Cánula aspiración universal protect, 16mm, gris <b>Ref.: 68-38024</b> (Ref. Dürr®: 0700.059.50)	<b>15<sup>80</sup>€</b> Para refs.: 68-38019 y 68-38020 Pack: 5 unidades <b>HASTA AGOTAR</b>
	Cánula aspiración profilaxis, 16mm, gris <b>Ref.: 68-38025</b> (Ref. Dürr®: 0700.058.50)	<b>17<sup>00</sup>€</b> Para refs.: 68-38019 y 68-38020 Pack: 4 unidades <b>HASTA AGOTAR</b>
	Cánula universal Petite, 16mm, gris <b>Ref.: 68-38036</b> (Ref. Dürr®: A700056050)	<b>10<sup>40</sup>€</b> Pack: 5 unidades <b>HASTA AGOTAR</b>

## Manguera fina DÜRR®



	Descripción	Observaciones
	Manguito giratorio 11mm. <b>Ref.: 68-38021</b>	<b>18<sup>80</sup>€</b>
	Manguito giratorio 11mm. <b>Ref.: 68-38022</b>	<b>7<sup>30</sup>€</b>
	Cánula aspiración universal Petite, 11mm, gris, <b>Ref.: 68-38026</b> (Ref. Dürr®: 0700.057.50)	<b>12<sup>80</sup>€</b> Para refs.: 68-38021 y 68-38022 Pack: 5 unidades <b>HASTA AGOTAR</b>

# RUMAR

PR ▶ **PEDALES  
Y SUS REPUESTOS**

# PEDALES FARO®

Pedales Faro®



### Descripción

### Observaciones

NUEVO



Pedal P2L1 con cable para Fedesa® con conector

Referencia utilizada por Fedesa®

Ref.: 80-224900055

438<sup>00</sup>€

NUEVO



Pedal P2L1 con cable para Fedesa®

Referencia utilizada por Fedesa®

Ref.: 80-224900050

418<sup>00</sup>€



Pedal con cable electropneumático P2L1 Faro®

Ref.: 80-224900000

483<sup>80</sup>€

EN STOCK!!!



Pedal con cable neumático P2L1 Faro®

Ref.: 80-224900100

421<sup>80</sup>€

BAJO PEDIDO



Pedal con cable electrico P2L1 Faro®

Ref.: 80-224900200

421<sup>80</sup>€

BAJO PEDIDO

NUEVO



Carcasa pedal P2L1 (sin movimientos)

Referencia utilizada por Fedesa®

Ref.: 80-654905 (Ref. Faro®: 224905)

32<sup>50</sup>€



Potenciómetro K10 pedal Faro®

Ref. Fedesa®: 244A56

Ref.: 80-604497

19<sup>80</sup>€









	Válvula FARO® 3 vías accionamiento pedal	Ref.: <b>80-604035</b> (Ref. Faro®: 224035)	30 <sup>80.€</sup>		
	Válvula proporcional flujo de aire pedales Faro® 224900000 y 224900100	Ref.: <b>80-604920</b> (Ref. Faro®: 224920)	88 <sup>80.€</sup>		
NUEVO		Base pedal P2L1	Ref.: <b>80-654901</b> (Ref. Faro®: 224901)	75 <sup>80.€</sup>	Referencia utilizada por Fedesa®
NUEVO		Tornillo pedal P2L1	Ref.: <b>80-654941</b> (Ref. Faro®: 224941)	3 <sup>80.€</sup>	Referencia utilizada por Fedesa®
NUEVO		Cable pedal P2L1	Ref.: <b>80-655051</b>	129 <sup>80.€</sup>	Referencia utilizada por Fedesa®
		Base plato pedal Faro®	Ref.: <b>80-654954</b> (Ref. Faro®: 224954)	5 <sup>80.€</sup>	

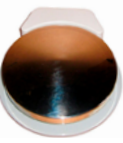

## Pedales Neumáticos

RUMAR



- Regulación progresiva del flujo de aire.
- Disco de acero de Cromo pulido, muy resistente y duradero.
- Valvulería de primera calidad.
- Con almohadillas antideslizantes.

	Descripción	Observaciones
	Pedal neumático con chip blower y con selector de agua  <b>Ref.: 37-200</b>	*No incluye manguera  <b>118'00€</b>
	Pedal neumático sin chip blower y sin selector de agua  <b>Ref.: 37-202</b>	*No incluye manguera  <b>74'80€</b>
	Base torre para válvulas con tornillo  <b>Ref.: 37-210</b>	  <b>9'80€</b>
	Válvula Hanger con puertos laterales + Pedales neumáticos RUMAR®  <b>Ref.: 37-211</b>	Estado: Normalmente abierta  <b>13'80€</b>
	Palanca control de agua  <b>Ref.: 37-212</b>	  <b>6'80€</b>
	Base de mandos  <b>Ref.: 37-213</b>	  <b>31'80€</b>
	Junta tórica con pasador  <b>Ref.: 37-214</b>	  <b>5'80€</b>
	Chip Blower metálico  <b>Ref.: 37-215</b>	  <b>9'80€</b>
	Patas de goma  <b>Ref.: 37-216</b>	  <b>2'80€</b>

\* VER MANGUERAS PARA PEDALES REFS.: 37-241 Y 44-850

SI NO ENCUENTRAS EL REPUESTO QUE BUSCAS, ¡CONSÚLTANOS!  
 Precios: impuestos, portes y mano de obra no incluidos.

	Descripción	Observaciones
	Junta interna válvula central  <b>Ref.: 37-217</b>	<b>1'40€</b>
	Muelle interno válvula central  <b>Ref.: 37-218</b>	<b>4'80€</b>
	Muelle central válvula central  <b>Ref.: 37-219</b>	<b>7'80€</b>
	Anillo tórico base  <b>Ref.: 37-220</b>	<b>2'00€</b>
	Estructura válvula central  <b>Ref.: 37-221</b>	<b>57'80€</b>
	Junta tórica "U" pistón  <b>Ref.: 37-222</b>	<b>2'00€</b>
	Pistón sin junta tórica  <b>Ref.: 37-223</b>	<b>7'80€</b>
	Espiga manguera macho  <b>Ref.: 50-532/5</b>	<b>6'75€</b> <b>Conexiones:</b> 10/32" x 1,6mm Pack 5 Unidades
	Anillo nylon rosca 10/32"  <b>Ref.: 50-720/10</b>	<b>4'50€</b> <b>Medidas:</b> 0,79 x 0,475 x 0,08mm Pack 10 Unidades
	Espiga manguera macho  <b>Ref.: 50-530/5</b>	<b>6'50€</b> <b>Conexiones:</b> 10/32" x 4,6mm Pack 5 Unidades

	Descripción	Observaciones
	<p>Disco metálico válvulas</p> <p>Ref.: <b>37-224</b></p>	<p><b>3<sup>00</sup>€</b></p>
	<p>Torre completa palanca control de agua</p> <p>Ref.: <b>37-225</b></p>	<p><b>31<sup>80</sup>€</b></p>
	<p>Torre completa Chip-Blower</p> <p>Ref.: <b>37-226</b></p>	<p><b>38<sup>00</sup>€</b></p>

**IMPORTANTE:**  
**Válvula central completa = 37-217 + 37-218 + 37-220 + 37-221 + 37-222 + 37-223**

# RUMAR

RCE

## ▶ RACORES, CONECTORES Y ESPIGAS

- Racorería, conectores y llaves de paso
- Espigas
- Conectores de Nylon

RUMAR

*DCI*



# RACORERÍA

- Conexión rápida, serie SC.
- Latón niquelado.
- Primera calidad.





## Rectos macho cónico

RUMAR

	Descripción		Observaciones
	3/8" x 8 mm. <b>Ref.: 50-009/5</b>	<b>11<sup>80</sup>€</b>	<b>Pack:</b> 5 unidades
	1/4" x 6 mm. <b>Ref.: 50-001/5</b>	<b>8<sup>80</sup>€</b>	<b>Pack:</b> 5 unidades
	1/4" x 8 mm. <b>Ref.: 50-002/5</b>	<b>8<sup>80</sup>€</b>	<b>Pack:</b> 5 unidades
	1/8" x 6 mm. <b>Ref.: 50-003/5</b>	<b>6<sup>00</sup>€</b>	<b>Pack:</b> 5 unidades
	1/8" x 8 mm. <b>Ref.: 50-004/5</b>	<b>7<sup>00</sup>€</b>	<b>Pack:</b> 5 unidades

## Rectos hembra



RUMAR

	Descripción		Observaciones
	1/4" x 6 mm. <b>Ref.: 50-005/5</b>	<b>10<sup>70</sup>€</b>	<b>Pack:</b> 5 unidades
	1/4" x 8 mm. <b>Ref.: 50-006/5</b>	<b>10<sup>50</sup>€</b>	<b>Pack:</b> 5 unidades
	1/8" x 6 mm. <b>Ref.: 50-007/5</b>	<b>8<sup>80</sup>€</b>	<b>Pack:</b> 5 unidades
	1/8" x 8 mm. <b>Ref.: 50-008/5</b>	<b>8<sup>80</sup>€</b>	<b>Pack:</b> 5 unidades

## Codos fijos, macho





RUMAR

	Descripción		Observaciones
	1/4" x 6 mm. <b>Ref.: 50-011/5</b>	<b>8<sup>80</sup>€</b>	<b>Pack:</b> 5 unidades

	Descripción	Observaciones
	1/4" x 8 mm. <b>Ref.: 50-012/5</b>	<b>Pack:</b> 5 unidades <b>9'70€</b>
	1/8" x 6 mm. <b>Ref.: 50-013/5</b>	<b>Pack:</b> 5 unidades <b>8'10€</b>
	1/8" x 8 mm. <b>Ref.: 50-014/5</b>	<b>Pack:</b> 5 unidades <b>8'90€</b>



## Codos fijos, hembra

RUMAR

	Descripción	Observaciones
	1/4" x 6 mm. <b>Ref.: 50-015/5</b>	<b>Pack:</b> 5 unidades <b>13'90€</b>
	1/4" x 8 mm. <b>Ref.: 50-016/5</b>	<b>Pack:</b> 5 unidades <b>15'00€</b>
	1/8" x 6 mm. <b>Ref.: 50-091/5</b>	<b>Pack:</b> 5 unidades <b>11'50€</b>
	1/8" x 8 mm. <b>Ref.: 50-092/5</b>	<b>Pack:</b> 5 unidades <b>12'30€</b>



## Codos Intermedios

RUMAR

	Descripción	Observaciones
	6 x 6 mm. <b>Ref.: 50-021/5</b>	<b>Pack:</b> 5 unidades <b>13'20€</b>
	8 x 8 mm. <b>Ref.: 50-022/5</b>	<b>Pack:</b> 5 unidades <b>15'60€</b>

## Prolongadores



RUMAR

	Descripción	Observaciones
	6 x 6 mm. <b>Ref.: 50-025/5</b>	<b>Pack:</b> 5 unidades <b>9'70€</b>
	8 x 8 mm. <b>Ref.: 50-026/5</b>	<b>Pack:</b> 5 unidades <b>11'40€</b>

	Descripción	Observaciones
	6 x 8 mm. <b>Ref.: 50-027/5</b>	<b>Pack:</b> 5 unidades <b>12'80€</b>



► "T" Intermedias

RUMAR

	Descripción	Observaciones
	6 x 6 x 6 mm. <b>Ref.: 50-031/5</b>	<b>Pack:</b> 5 unidades <b>17'80€</b>
	8 x 8 x 6 mm. <b>Ref.: 50-033/5</b>	<b>Pack:</b> 5 unidades <b>20'30€</b>
	8 x 8 x 8 mm. <b>Ref.: 50-032/5</b>	<b>Pack:</b> 5 unidades <b>20'70€</b>



► "T" Lateral macho cónico

RUMAR

	Descripción	Observaciones
	1/4" x 6 x 6 mm. <b>Ref.: 50-035</b>	<b>3'10€</b>
	1/4" x 8 x 8 mm. <b>Ref.: 50-036</b>	<b>3'50€</b>



► "T" Central macho cónico

RUMAR

	Descripción	Observaciones
	1/4" x 6 x 6 mm. <b>Ref.: 50-041</b>	<b>3'00€</b>
	1/4" x 8 x 8 mm. <b>Ref.: 50-042</b>	<b>3'50€</b>

► Cruz intermedia

RUMAR





	Descripción	Observaciones
	6 x 6 x 6 x 6 mm. <b>Ref.: 50-045</b>	<b>5'30€</b>
	8 x 8 x 8 x 8 mm. <b>Ref.: 50-046</b>	<b>6'20€</b>



# CONECTORES RÁPIDOS AIRE EASY

## Rectos macho

RUMAR



	Descripción	Observaciones
	1/4" x 8 mm. <b>Ref.: 50-070/5</b>	<b>Pack:</b> 5 unidades <b>11'25€</b>
	1/4" x 6 mm. <b>Ref.: 50-071/5</b>	<b>Pack:</b> 5 unidades <b>11'80€</b>
	1/8" x 8 mm. <b>Ref.: 50-072/5</b>	<b>Pack:</b> 5 unidades <b>12'30€</b>
	1/8" x 6 mm. <b>Ref.: 50-073/5</b>	<b>Pack:</b> 5 unidades <b>10'80€</b>

# UNIONES RÁPIDAS ENGANCHE METÁLICO

SISTEMA ANTI ESCAPE DE TUBOS - MAYOR DURABILIDAD



## Uniones

RUMAR

	Descripción	Observaciones
	4 x 4 mm. <b>Ref.: 50-087/5</b>	<b>Pack:</b> 5 unidades <b>15'20€</b>
	6 x 6 mm. <b>Ref.: 50-081/5</b>	<b>Pack:</b> 5 unidades <b>16'50€</b>
	8 x 8 mm. <b>Ref.: 50-082/5</b>	<b>Pack:</b> 5 unidades <b>19'00€</b>



## Uniones reductoras

RUMAR

	Descripción	Observaciones
	6 x 8 mm. <b>Ref.: 50-083/5</b>	<b>Pack:</b> 5 unidades <b>19'80€</b>
	4 x 6 mm. <b>Ref.: 50-088/5</b>	<b>Pack:</b> 5 unidades <b>18'80€</b>





## "T" Intermedias

RUMAR

	Descripción	Observaciones
	8 x 8 x 8 mm. Ref.: <b>50-080/5</b>	Pack: 5 unidades <b>30<sup>´</sup>20€</b>
	6 x 6 x 6 mm. Ref.: <b>50-084/5</b>	Pack: 5 unidades <b>27<sup>´</sup>40€</b>





## Conectores Rápidos Agua/Aire DCI

DCI

	Descripción	Observaciones
	Hembra conexión rápida para tubo de <b>4x6mm</b> . Ref.: <b>50-0011</b>	Suministros incluye: arandelas de colores para identificación. Aire o Agua <b>19<sup>´</sup>80€</b>
	Macho conexión rápida para tubo de <b>4x6mm</b> . Ref.: <b>50-0014</b>	Aire o Agua <b>19<sup>´</sup>80€</b>
	Conexión rápida macho agua / aire para tubo de <b>4x6mm</b> . Ref.: <b>28-U054</b>	<b>9<sup>´</sup>80€</b>
	Conexión rápida hembra agua / aire para tubo de <b>4x6mm</b> . Ref.: <b>28-U055</b>	<b>9<sup>´</sup>80€</b>

## Accesorios

RUMAR

	Descripción	Observaciones
	Válvula Antirretorno 1/4" x 1/4", hembra / hembra. Ref.: <b>50-061</b>	<b>8<sup>´</sup>00€</b>
	Válvula Antirretorno 1/8" x 1/8", hembra / hembra. Ref.: <b>50-066</b>	<b>7<sup>´</sup>00€</b>
	Mini válvula Antirretorno 10/32" x 1,6mm. Ref.: <b>50-570</b>	<b>9<sup>´</sup>80€</b>
	Mini válvula Antirretorno 1,6mm x 1,6mm. Ref.: <b>50-571</b>	<b>11<sup>´</sup>80€</b>
	Mini válvula Antirretorno M5 x M5, hembra / hembra Ref.: <b>50-572</b>	(Ref: Fedesa® 247A18) <b>12<sup>´</sup>80€</b>

NUEVO

## Pasatabiques

RUMAR

## Descripción

Pasatabiques 1/8" x 1/8", macho / hembra.

Ref.: 50-090/5

11'80€

## Observaciones

Pack: 5 unidades

(Ref. Fedesa® 575A66)

NUEVO



## Uniones

RUMAR

## Descripción

Unión 1/4" x 1/4", macho / macho.

Ref.: 50-085/5

5'40€

## Observaciones

Pack: 5 unidades



Unión 1/8" x 1/8", macho / macho.

Ref.: 50-086/5

3'70€

Pack: 5 unidades



Unión 1/8" x 1/8", hembra / macho.

Ref.: 50-089/5

4'80€

Pack: 5 unidades

(Ref. Fedesa® 575A31)

NUEVO



## Reductores

RUMAR

## Descripción

Reductor 1/4" macho x 1/8" hembra.

Ref.: 50-062/5

4'50€

## Observaciones

Pack: 5 unidades



Reductor 3/8" macho x 1/4" hembra.

Ref.: 50-064/5

5'60€

Pack: 5 unidades



Reductor 1/2" macho x 1/4" hembra.

Ref.: 50-067/5

9'80€

Pack: 5 unidades



Reductor 1/8" macho x 10/32" hembra.

Ref.: 50-565/5

32'80€

Pack: 5 unidades



Imagen no disponible

Reductor 1/8" macho x 1/4" hembra.

Ref.: 50-063/5

6'40€

Pack: 5 unidades



Reductor 1/2" hembra x 1/4" hembra.

Ref.: 50-069/5

11'80€

Pack: 5 unidades

(Ref. Fedesa® 575A85)

NUEVO





Reductor 1/4" macho x 3/8" hembra.

Ref.: 50-068/5

10<sup>80</sup>€

Pack: 5 unidades

## Codos fijos

RUMAR

## Descripción

## Observaciones

Codo 3/8" x 3/8", hembra / macho.

Ref.: 50-094/5

16<sup>80</sup>€

Pack: 5 unidades

(Ref. Fedesa® 575A122)

Codo 1/4" x 1/4", hembra / macho.

Ref.: 50-095/5

11<sup>80</sup>€

Pack: 5 unidades

Codo 1/8" x 1/8", hembra / macho.

Ref.: 50-096/5

8<sup>80</sup>€

Pack: 5 unidades

## "T" central

RUMAR

## Descripción

## Observaciones

"T" 1/4" macho a 2x 1/4" hembra

Ref.: 50-093/5

14<sup>80</sup>€

Pack: 5 unidades

"T" 1/8" macho a 2x 1/8" hembra

Ref.: 50-097/5

11<sup>80</sup>€

Pack: 5 unidades

(Ref. Fedesa® 575A59)

## Llaves de paso

RUMAR

## Descripción

## Observaciones

Llave de paso 1/2" x 1/2" macho / hembra

Ref.: 50-254

8<sup>00</sup>€

(Ref. Fedesa® 770A16)

Llave de paso 1/4" x 1/4" macho / macho.

Ref.: 50-250

8<sup>10</sup>€

Llave de paso 1/4" x 1/4" macho / hembra.

Ref.: 50-251

6<sup>70</sup>€

Llave de paso 1/4" x 1/4" hembra / hembra.

Ref.: 50-252



8<sup>50</sup>€

Llave de paso 1/8" x 1/8" macho / hembra.











Ref.: 50-253



8<sup>00</sup>€

Varios

NUEVO		Llave de retención compresores 3/8" Ref.: <b>50-258</b>	(Ref. Fedesa® 175A35) 12 <sup>80</sup> €
NUEVO	 <small>Imagen no disponible</small>	Grifo purga 1/4", cierre tórica Ref.: <b>50-259/5</b>	Pack: 5 unidades (Ref. Fedesa® 415A11) 14 <sup>80</sup> €

Espigas manguera, macho

	Descripción		Observaciones
	 1/4" x 6 mm. Ref.: <b>50-051/5</b>	5 <sup>90</sup> €	Pack: 5 unidades
	 1/4" x 8 mm. Ref.: <b>50-052/5</b>	6 <sup>40</sup> €	Pack: 5 unidades
NUEVO	 1/4" x 12 mm. Ref.: <b>50-050/5</b>	6 <sup>80</sup> €	Pack: 5 unidades
	 1/8" x 6 mm. Ref.: <b>50-053/5</b>	5 <sup>20</sup> €	Pack: 5 unidades
	 1/8" x 8 mm. Ref.: <b>50-054/5</b>	5 <sup>20</sup> €	Pack: 5 unidades
NUEVO	 3/8" x 12 mm. Ref.: <b>50-057/5</b>	8 <sup>80</sup> €	Pack: 5 unidades (Ref. Fedesa® 575A121)
NUEVO	 3/8" x 18 mm. Ref.: <b>50-058/5</b>	12 <sup>80</sup> €	Pack: 5 unidades (Ref. Fedesa® 575A120)
	 10/32" x 3,2 mm Ref.: <b>50-530/5</b>	6 <sup>50</sup> €	Pack: 5 unidades 3,2mm = Tubo diametro interno: 4mm (Ref.: 50-100 y 50-10025)
	 10/32" x 2,5 mm Ref.: <b>50-542/5</b>	6 <sup>50</sup> €	Pack: 5 unidades 2,5mm = Tubo diametro interno: 2,8 mm (Ref.: 50-50310 y 50-60310)
	 10/32" x 1,6 mm Ref.: <b>50-532/5</b>	6 <sup>75</sup> €	Pack: 5 unidades 1,6mm = Tubo diametro interno: 1,4 mm (Ref.: 50-10410 y 50-50410)
	 M5 x 3,2 mm Ref.: <b>50-540/5</b>	6 <sup>50</sup> €	Pack: 5 unidades 3,2mm = Tubo diametro interno: 4mm (Ref.: 50-100 y 50-10025)

	Descripción	Observaciones
	M5 x 1,6 mm <b>Ref.: 50-541/5</b>	<b>Pack:</b> 5 unidades <b>1,6mm</b> = Tubo diámetro interno: 1,4 mm (Ref: 50-10410 y 50-50410) <b>6'50€</b>
	10/32" x 3,2 mm <b>Ref.: 50-537/5</b>	<b>Rosca extra larga</b> <b>Pack:</b> 5 unidades <b>3,2mm</b> = Tubo diámetro interno: 4mm (Ref: 50-100 y 50-10025) <b>6'50€</b>
	10/32" x 1,6 mm <b>Ref.: 50-538/5</b>	<b>Rosca extra larga</b> <b>Pack:</b> 5 unidades <b>1,6mm</b> = Tubo diámetro interno: 1,4 mm (Ref: 50-10410 y 50-50410) <b>6'75€</b>
	8/32" x 1,6 mm <b>Ref.: 50-543/5</b>	<b>Pack:</b> 5 unidades <b>1,6mm</b> = Tubo diámetro interno: 1,4 mm (Ref: 50-10410 y 50-50410) <b>6'50€</b>



Uniones macho / macho



	Descripción	Observaciones
	Reductora 3,2mm a 2,5mm <b>Ref.: 50-533/5</b>	<b>Pack:</b> 5 unidades <b>3,2mm</b> = Tubo diámetro interno: 4mm (Ref: 50-100 y 50-10025) <b>2,5mm</b> = Tubo diámetro interno: 2,8 mm (Ref: 50-50310 y 50-60310) <b>10'00€</b>
	Reductora 3,2mm a 1,6mm <b>Ref.: 50-534/5</b>	<b>Pack:</b> 5 unidades <b>3,2mm</b> = Tubo diámetro interno: 4mm (Ref: 50-100 y 50-10025) <b>1,6mm</b> = Tubo diámetro interno: 1,4 mm (Ref: 50-10410 y 50-50410) <b>12'00€</b>
	Reductora 2,5mm a 1,6mm <b>Ref.: 50-535/5</b>	<b>Pack:</b> 5 unidades <b>2,5mm</b> = Tubo diámetro interno: 2,8 mm (Ref: 50-50310 y 50-60310) <b>1,6mm</b> = Tubo diámetro interno: 1,4 mm (Ref: 50-10410 y 50-50410) <b>12'00€</b>
	Uniones 1,6mm a 1,6mm <b>Ref.: 50-536/5</b>	<b>Pack:</b> 5 unidades <b>1,6mm</b> = Tubo diámetro interno: 1,4 mm (Ref: 50-10410 y 50-50410) <b>12'00€</b>



Tapón macho



	Descripción	Observaciones
	Tapón macho 1/4" con tórica x Allen. <b>Ref.: 50-055/5</b>	<b>Pack:</b> 5 unidades <b>4'70€</b>
	Tapón macho 1/8" x hexagonal. <b>Ref.: 50-056/5</b>	<b>Pack:</b> 5 unidades <b>3'70€</b>
	Tapón macho 10/32" x hexagonal. <b>Ref.: 50-539/5</b>	<b>Pack:</b> 5 unidades <b>3'75€</b>



## Abrazaderas de seguridad de metal

RUMAR

	Descripción	Observaciones
	Abrazadera de seguridad de metal para tubo de 1,6x2,5mm. <b>Ref.: 50-550</b>	0'75€
	Abrazadera de seguridad de metal para tubo de 2,5x4mm. <b>Ref.: 50-551</b>	0'75€

## Junta de Nylon

RUMAR

	Descripción	Observaciones
	Rosca 10/32" y M5. <b>Ref.: 50-720/10</b>	<b>Medidas:</b> 0,79x0,475x0,08mm <b>Pack:</b> 10 unidades 4'50€
	Rosca #6. <b>Ref.: 50-721/10</b>	<b>Medidas:</b> 0,79x0,353x0,08mm <b>Pack:</b> 10 unidades 4'50€
	Rosca #8. <b>Ref.: 50-722/10</b>	<b>Medidas:</b> 0,63x0,41x0,08mm <b>Pack:</b> 10 unidades 4'50€



## TUBOS

## Poliuretano

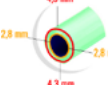
RUMAR

	Descripción	Observaciones
	Tubo poliuretano aire / agua, 4 x 6 mm (máx 10 bar) <b>Azul</b> <b>Ref.: 50-100</b>	<b>Por metro</b> - <b>Compra mín.</b> 10m / múltiplo de 5m <b>NO ADMITEN DEVOLUCIÓN</b> 1'90€
	Tubo poliuretano aire / agua, 4 x 6 mm (máx 10 bar) <b>Azul</b> <b>Ref.: 50-10025</b>	<b>Caja 25 metros</b> 30'80€
	Tubo poliuretano aire / agua, 6 x 8 mm (máx 20 bar) <b>Azul</b> <b>Ref.: 50-101</b>	<b>Por metro</b> - <b>Compra mín.</b> 10m / múltiplo de 5m <b>NO ADMITEN DEVOLUCIÓN</b> 2'10€
	Tubo poliuretano aire / agua, 6 x 8 mm (máx 20 bar) <b>Azul</b> <b>Ref.: 50-10125</b>	<b>Caja 25 metros</b> 36'80€
	Tubo poliuretano aire / agua, 4 x 6 mm (máx 10 bar) <b>Verde</b> <b>Ref.: 50-20025</b>	<b>Caja 25 metros</b> Especialmente diseñada para agua. Mayor resistencia. (Ref. Fedesa® 733A65) 36'80€
	Tubo poliuretano aire / agua, 2,8 x 4,3 mm <b>Verde transparente</b> <b>Ref.: 50-50310</b>	<b>Rollo 10 metros</b> <b>NO ADMITEN DEVOLUCIÓN</b> 28'00€

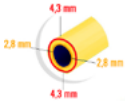
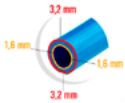
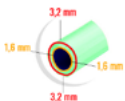
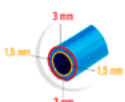
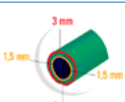
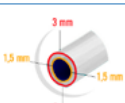

NUEVO

	Descripción	Observaciones
	Tubo poliuretano aire / agua, 2,8 x 4,3 mm <b>Amarillo</b> Ref.: <b>50-60310</b>	Rollo 10 metros NO ADMITEN DEVOLUCIÓN 28´00€
	Tubo poliuretano aire / agua, 1,6 x 3,2 mm <b>Azul</b> Ref.: <b>50-10410</b>	Rollo 10 metros NO ADMITEN DEVOLUCIÓN 21´80€
	Tubo poliuretano aire / agua, 1,6 x 3,2 mm <b>Verde transparente</b> Ref.: <b>50-50410</b>	Rollo 10 metros NO ADMITEN DEVOLUCIÓN 21´80€
<b>NUEVO</b> 	Tubo poliuretano aire / agua, 1,5 x 3 mm <b>Azul</b> Ref.: <b>50-10210</b>	Rollo 10 metros (Ref. Fedesa® 733A72) NO ADMITEN DEVOLUCIÓN 8´00€
<b>NUEVO</b> 	Tubo poliuretano aire / agua, 1,5 x 3 mm <b>Verde</b> Ref.: <b>50-20210</b>	Rollo 10 metros (Ref. Fedesa® 733A75) NO ADMITEN DEVOLUCIÓN 8´00€
<b>NUEVO</b> 	Tubo poliuretano aire / agua, 1,5 x 3 mm <b>Transparente</b> Ref.: <b>50-40210</b>	Rollo 10 metros (Ref. Fedesa® 733A78) NO ADMITEN DEVOLUCIÓN 8´00€
	Pinza cortatubos, modelo PT Ref.: <b>50-065</b>	12´40€

## CONECTORES DE NYLON

### Uniones





RUMAR

	Descripción	Observaciones
	1,6 X 1,6 mm. Ref.: <b>50-300</b>	Pack: 10 unidades 10´80€
	2,4 X 2,4 mm. Ref.: <b>50-301</b>	Pack: 10 unidades 10´80€
	3,2 X 3,2 mm. Ref.: <b>50-302</b>	Pack: 10 unidades 10´80€





## Uniones reductoras

RUMAR

	Descripción		Observaciones
	4 x 1,6 mm. Ref.: 50-350	11'80€	Pack: 10 unidades
	4 mm x 2,4 mm. Ref.: 50-351	11'80€	Pack: 10 unidades
	3,2 x 1,6 mm. Ref.: 50-352	9'80€	Pack: 10 unidades
	3,2 x 2,4 mm. Ref.: 50-353	9'80€	Pack: 10 unidades



## "T"

RUMAR

	Descripción		Observaciones
	1,6 x 1,6 X 1,6 mm. Ref.: 50-320	13'80€	Pack: 10 unidades
	2,4 x 2,4 X 2,4 mm. Ref.: 50-321	13'80€	Pack: 10 unidades
	3,2 x 3,2 X 3,2 mm. Ref.: 50-322	13'80€	Pack: 10 unidades

## "T" reductora

RUMAR

	Descripción		Observaciones
	2 x 3,2mm + 1 x 1,6mm. Ref.: 50-323	14'30€	Pack: 10 unidades
	2 x 3,2mm + 1 x 2,4 mm. Ref.: 50-324	14'30€	Pack: 10 unidades



## "Y"

RUMAR

	Descripción		Observaciones
	1,6 x 1,6 X 1,6 mm. Ref.: 50-330	11'80€	Pack: 10 unidades

## Cruz

RUMAR

	Descripción		Observaciones
	1,6 x 1,6 x 1,6 X 1,6 mm. Ref.: 50-340	18'20€	Pack: 10 unidades HASTA AGOTAR
	2,4 x 2,4 x 2,4 X 2,4 mm. Ref.: 50-341	18'20€	Pack: 10 unidades HASTA AGOTAR
	3,2 x 3,2 x 3,2 X 3,2 mm. Ref.: 50-342	18'20€	Pack: 10 unidades HASTA AGOTAR

## Tapones

RUMAR

	Descripción		Observaciones
	1,6 mm. Ref.: 50-360	6'80€	Pack: 10 unidades HASTA AGOTAR

# RUMAR

## VE ▶ VÁLVULAS Y ELECTROVÁLVULAS

- Válvulas (Faro®, Clippard®, RUMAR®)
- Electroválvulas (Sirai® / ASCO® NEUMATICS)



*Clippard* RUMAR



ASCO™



# VÁLVULAS

## Válvulas FARO®



	Descripción	Observaciones
	Válvula agua selección de instrumentos  <b>Ref.: 80-603400</b> (Ref. Faro®: 223400)	53'80€
	Válvula 3 vías accionamiento pedal  <b>Ref.: 80-604035</b> (Ref. Faro®: 224035)	30'80€
	Válvula apertura agua con aspiración  <b>Ref.: 80-604639</b> (Ref. Faro®: 224639)	84'80€
	Válvula agua comando aire  <b>Ref.: 80-604679</b> (Ref. Faro®: 224679)	98'80€
	Distribuidor  <b>Ref.: 80-604248</b> (Ref. Faro®: 234248)	<b>Entrada:</b> 1x3,2mm <b>Salidas:</b> 3x1,6mm  74'80€
	Válvula proporcional flujo de aire pedales Faro® 224900000 y 224900100  <b>Ref.: 80-604920</b> (Ref. Faro®: 224920)	88'00€
	Membrana válvula agua  <b>Ref.: 80-603033</b> (Ref. Faro®: 223033)	5'30€
	Membrana válvula neumática instrumento  <b>Ref.: 80-603147</b> (Ref. Faro®: 223147)	4'30€
	Membrana válvula eléctrica instrumento  <b>Ref.: 80-603252</b> (Ref. Faro®: 223252)	5'50€

OTRAS REFERENCIAS DISPONIBLES CONSÚLTANOS

	Descripción	Observaciones
	Válvula solenoide  <b>Ref.: 80-603162</b> (Ref. Faro®: 223162)	<b>Voltaje:</b> 24V DC / CC <b>Potencia:</b> 1,3W <b>Estado:</b> normalmente abierta <b>Presión Máx.:</b> 7 bar  <b>52<sup>80</sup>€</b>
	Válvula solenoide  <b>Ref.: 80-603164</b> (Ref. Faro®: 223164)	<b>Voltaje:</b> 24V AC / CA 50/60 Hz <b>Potencia:</b> 1,3W <b>Estado:</b> normalmente abierta <b>Presión Máx.:</b> 7 bar  <b>54<sup>80</sup>€</b>
	Interruptor electroneumático  <b>Ref.: 80-654331</b> (Ref. Faro®: 224331)	          <b>33<sup>80</sup>€</b>
	Válvula doble, un sentido  <b>Ref.: 80-604265</b> (Ref. Faro®: 224265)	          <b>49<sup>80</sup>€</b>
	Llave de regulación FARO® aire/agua  <b>Ref.: 80-608030</b> (Ref. Faro®: 118030)	<b>Conexiones:</b> 1,6mm <b>Con empuñadura</b>          <b>45<sup>80</sup>€</b>
	Llave de regulación aire/agua  <b>Ref.: 80-607070</b> (Ref. Faro®: 117070)	<b>Conexiones:</b> 1,6mm <b>Sin empuñadura</b>          <b>25<sup>80</sup>€</b>
	Llave de regulación aire/agua  <b>Ref.: 80-600367</b> (Ref. Faro®: 200367)	<b>Conexiones:</b> 2,6mm <b>Sin empuñadura</b>          <b>24<sup>80</sup>€</b>
	Llave de regulación aire/agua  <b>Ref.: 80-604170</b> (Ref. Faro®: 224170)	<b>Conexiones:</b> 3,2mm <b>Sin empuñadura</b>          <b>25<sup>80</sup>€</b>

OTRAS REFERENCIAS DISPONIBLES CONSÚLTANOS

SI NO ENCUENTRAS EL REPUESTO QUE BUSCAS, ¡CONSÚLTANOS!  
 Precios: impuestos, portes y mano de obra no incluidos.

Bloques válvulas FARO®



	Descripción	Observaciones
	<p>Bloque 3 instrumentos (<u>operación eléctrica</u>)</p> <p>También disponible para 1 o 2 instrumentos y sin tapa de cierre. Consultar</p> <p><b>Ref.: 80-603300</b> (Ref. Faro®: 223300)</p>	<p><b>Voltaje:</b> 24V DC / CC</p>
	<p>Módulo de ampliación de bloques Faro® (<u>operación eléctrica</u>)</p> <p><b>Ref.: 80-603250</b> (Ref. Faro®: 223250)</p>	<p><b>Voltaje:</b> 24V DC / CC</p>
	<p>Bloque 3 instrumentos (<u>operación eléctrica</u>)</p> <p>También disponible para 1 o 2 instrumentos y sin tapa de cierre. Consultar</p> <p><b>Ref.: 80-603305</b> (Ref. Faro®: 223305)</p>	<p><b>Voltaje:</b> 24V AC / CA</p> <p>Referencia utilizada por Fedesa®</p>
	<p>Bloque 2 instrumentos (<u>operación eléctrica</u>)</p> <p><b>Ref.: 80-603296</b> (Ref. Faro®: 223296)</p>	<p><b>Voltaje:</b> 24V AC / CA</p> <p>Referencia utilizada por Fedesa®</p>
	<p>Módulo de ampliación de bloques Faro® (<u>operación eléctrica</u>)</p> <p><b>Ref.: 80-603255</b> (Ref. Faro®: 223255)</p>	<p><b>Voltaje:</b> 24V AC / CA</p> <p>Referencia utilizada por Fedesa®</p>
	<p>Bloque 4 vías, 3 instrumentos (<u>operación neumática</u>)</p> <p>También disponible para 1 o 2 instrumentos y sin tapa de cierre. Consultar</p> <p><b>Ref.: 80-603345</b> (Ref. Faro®: 223345)</p>	<p>Referencia utilizada por Fedesa®</p>
	<p>Bloque 2 instrumentos (<u>operación neumática</u>)</p> <p><b>Ref.: 80-603149</b> (Ref. Faro®: 223149)</p>	<p>Referencia utilizada por Fedesa®</p>
	<p>Módulo de ampliación de bloques Faro® (<u>operación neumática</u>)</p> <p><b>Ref.: 80-603201</b> (Ref. Faro®: 223201)</p>	<p>Referencia utilizada por Fedesa®</p>
	<p>Espiga para bloques y válvulas Faro® tubo 2,6mm/3,2mm</p> <p><b>Ref.: 80-600128</b> (Ref. Faro®: 250128)</p>	<p><b>4´60€</b></p>
	<p>Espiga para bloques y válvulas Faro® tubo 1,5mm/2,0mm</p> <p><b>Ref.: 80-600129</b> (Ref. Faro®: 250129)</p>	<p><b>4´60€</b></p>

OTRAS REFERENCIAS DISPONIBLES CONSÚLTANOS

NUEVO

Ampliación de bloques FARO® (Ver páginas siguientes)



	Descripción	Observaciones
	Junta de Nylon para espigas bloques y válvulas Faro®  <b>Ref.: 80-600131</b> (Ref. Faro®: 250131)	1'10€
	Tuerca ampliación bloques Faro®  <b>Ref.: 80-609025</b> (Ref. Faro®: 609025)	1'30€
	Tornillo ampliación bloques Faro®  <b>Ref.: 80-603208</b> (Ref. Faro®: 223208)	Largo: 33mm (+1 puesto)  3'80€
	Tornillo ampliación bloques Faro®  <b>Ref.: 80-603166</b> (Ref. Faro®: 223166)	Largo: 55mm (+2 puestos)  4'80€
	Anillo tórico bloques Faro®  <b>Ref.: 80-605019</b> (Ref. Faro®: 055019)	1'10€

OTRAS REFERENCIAS DISPONIBLES CONSÚLTANOS

SI NO ENCUENTRAS EL REPUESTO QUE BUSCAS, ¡CONSÚLTANOS!  
 Precios: impuestos, portes y mano de obra no incluidos.

## AMPLIACIÓN BLOQUE NEUMÁTICO:

80-603345

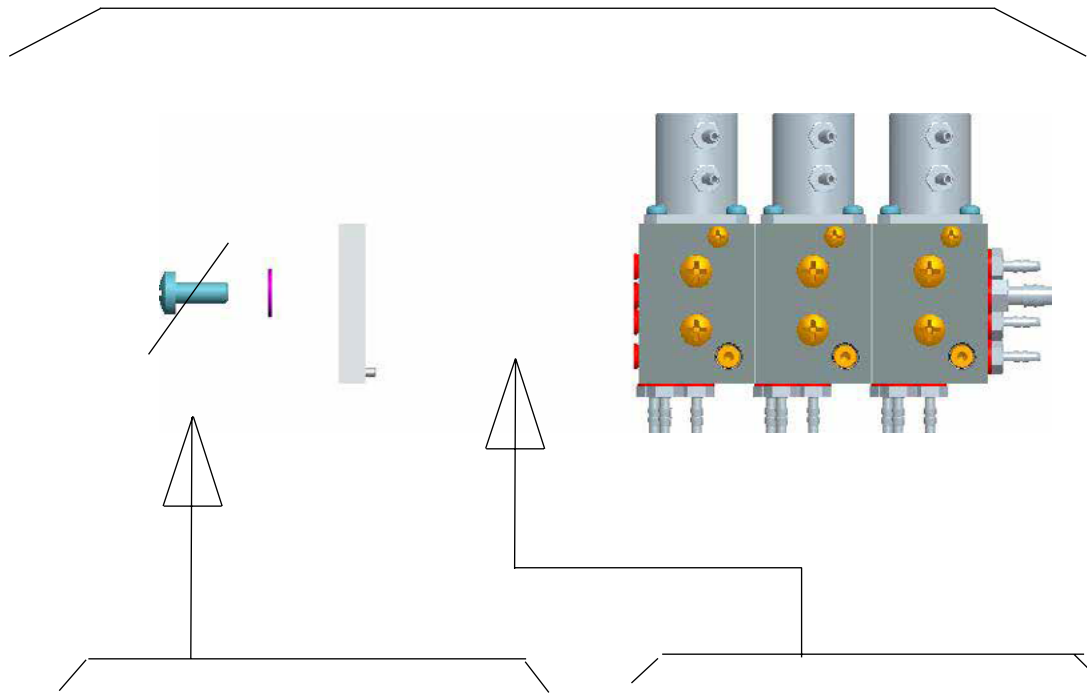

80-609025

80-603208  
(+1 PUESTO)

80-603166  
(+2 PUESTO)

80-605019

80-603201



## AMPLIACIÓN BLOQUE ELÉCTRICO CA/AC:

80-603305

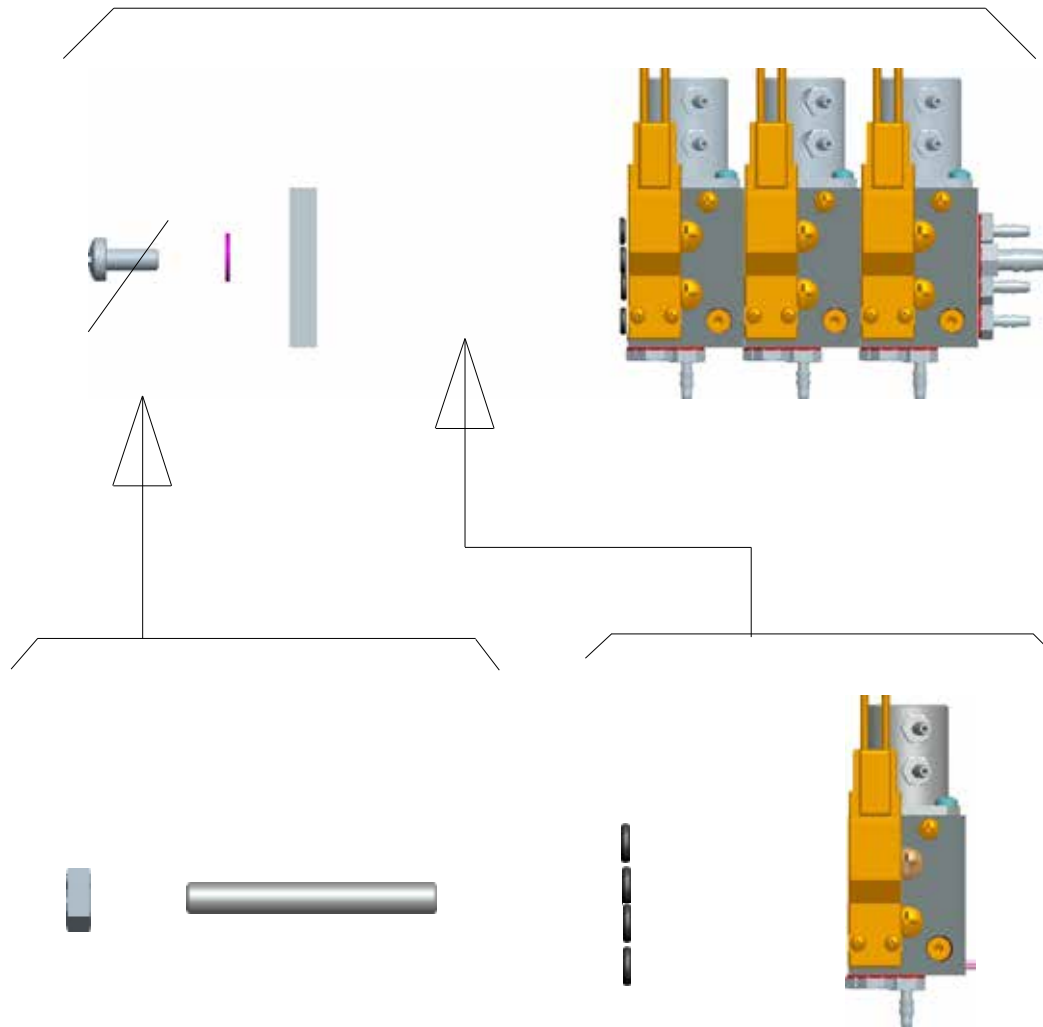

80-609025

80-603208  
(+1 PUESTO)

80-605019

80-603255

80-603166  
(+2 PUESTO)

## AMPLIACIÓN BLOQUE ELÉCTRICO CC/DC:

80-603300

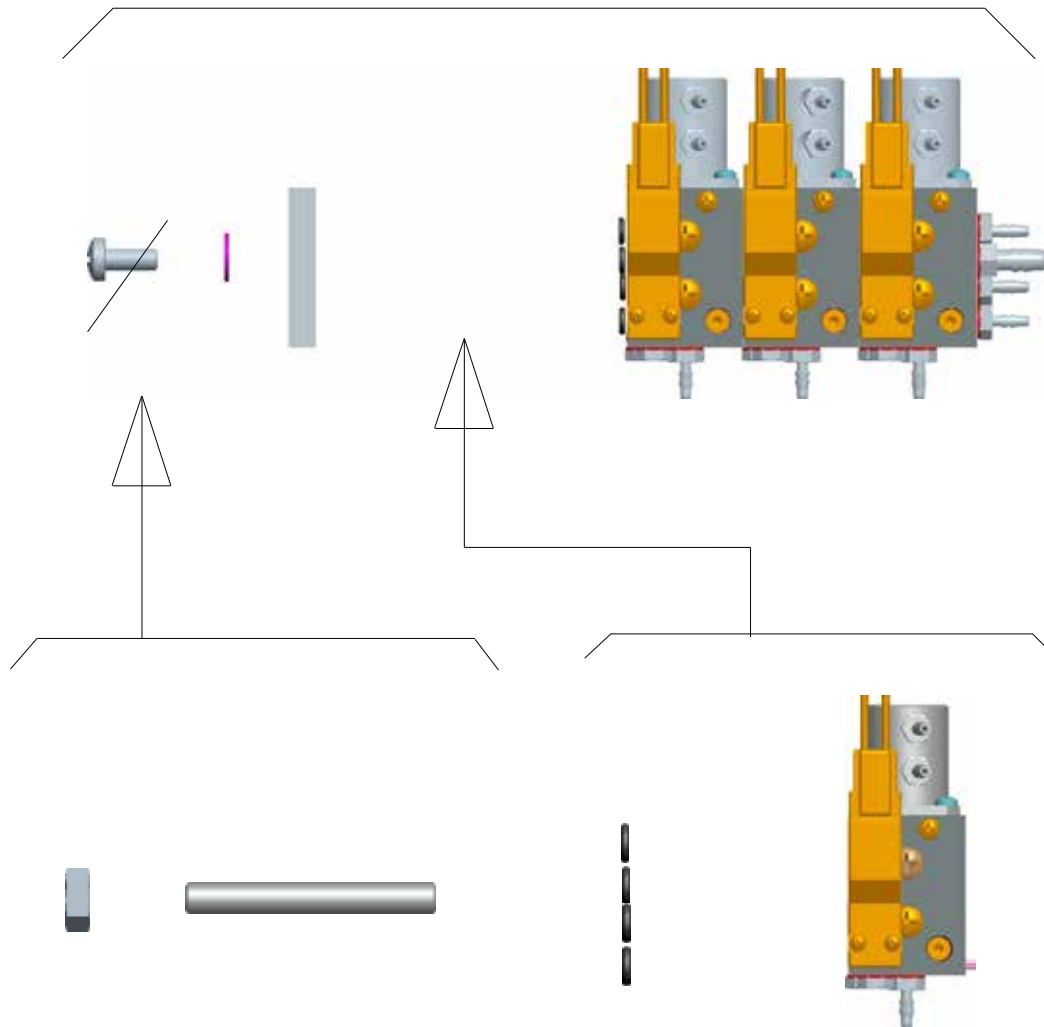

80-609025

80-603208  
(+1 PUESTO)

80-603166  
(+2 PUESTO)

80-605019

80-603250

Válvulas bloques RUMAR®



RUMAR

- Primera calidad.
- Acabados y tolerancias según normas DIN.
- **Garantía** 6 meses.

	Descripción	Observaciones
	Válvula bloque RUMAR® 3 instrumentos, <b>tipo DCI</b>  <b>Ref.: VE-703</b>	<b>Conexiones:</b> 10/32" <b>Incluye espigas</b>  <b>88´00€</b>
	Válvula bloque RUMAR® 4 instrumentos, <b>tipo DCI</b>  <b>Ref.: VE-704</b>	<b>Conexiones:</b> 10/32" <b>Incluye espigas</b>  <b>94´80€</b>
	Válvula bloque RUMAR® 3 instrumentos, <b>Standard</b>  <b>Ref.: VE-713</b>	<b>Conexiones:</b> 10/32" <b>Incluye espigas</b>  <b>88´00€</b>
	Válvula bloque RUMAR® 4 instrumentos, <b>Standard</b>  <b>Ref.: VE-714</b>	<b>Conexiones:</b> 10/32" <b>Incluye espigas</b>  <b>94´80€</b>

Membranas bloques RUMAR®

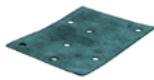
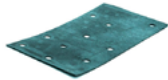

RUMAR

	Descripción	Observaciones
	Membrana bloque RUMAR® 3 instrumentos, <b>tipo DCI (Ref.: VE-703)</b>  <b>Ref.: VE-7031</b>	Compatible con FED-317A04 (Ref. Fedesa® 317A02)  <b>14´80€</b>
	Membrana bloque RUMAR® 4 instrumentos, <b>tipo DCI (Ref.: VE-704)</b>  <b>Ref.: VE-7041</b>	<b>14´80€</b>
	Membrana bloque RUMAR® 3 instrumentos, <b>Standard (Ref.: VE-713)</b>  <b>Ref.: VE-7131</b>	<b>14´80€</b>
	Membrana bloque RUMAR® 4 instrumentos, <b>Standard (Ref.: VE-714)</b>  <b>Ref.: VE-7141</b>	<b>14´80€</b>

Válvulas **Clippard**<sup>®</sup>

*Clippard*

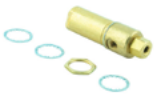
- Primera calidad.
- Acabados y tolerancias según normas DIN.
- **Garantía** 3 meses.









	Descripción	Observaciones
	Válvula antigoteo Relay WDV-2  <b>Ref.: VE-600</b>	<b>Conexiones:</b> 10/32" <b>Agua</b>  (Ref Fedesa 770A04)  <b>49<sup>80</sup>€</b>
	Válvula corte aire/agua <u>sin retracción</u>  <b>Ref.: VE-602</b>	<b>Conexiones:</b> 10/32" <b>Aire y Agua</b>
	Mini válvula SMAV-3 control pértigas colibrí  <b>Ref.: VE-620</b>	<b>Aire</b>  (Ref Fedesa 770A01)  <b>53<sup>80</sup>€</b>

Válvulas **RUMAR**<sup>®</sup>

**RUMAR**

- Primera calidad.
- Acabados y tolerancias según normas DIN.
- **Garantía** 3 meses.









	Descripción	Observaciones
	Válvula antigoteo  <b>Ref.: VE-590</b>	<b>Conexiones:</b> 10/32" <b>Agua</b> <b>Incluye espigas de 10/32" x 1,6mm</b>
	Válvula neumática ON/OFF, 3 vías  <b>Ref.: VE-740</b>	<b>Conexiones:</b> 10/32" <b>Estado:</b> Normalmente cerrada <b>Agua</b>
	Válvula Hanger con puertos laterales  <b>Ref.: 37-211</b>	<b>Estado:</b> Normalmente abierta
	Válvula Hanger con puertos laterales  <b>Ref.: VE-731</b>	<b>Estado:</b> Normalmente cerrada

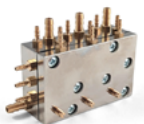
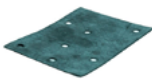

	Descripción	Observaciones
	<p>Válvula Hanger con puertos traseros</p> <p>Ref.: <b>VE-732</b></p> <p>8´80€</p>	<p>Estado: Normalmente abierta</p> <p>HASTA AGOTAR</p>
	<p>Válvula Hanger con puertos traseros</p> <p>Ref.: <b>VE-733</b></p> <p>8´80€</p>	<p>Estado: Normalmente cerrada</p> <p>HASTA AGOTAR</p>
	<p>Válvula ON/OFF con palanca gris, 2 vías, liberación rápida</p> <p>Ref.: <b>VE-735</b></p> <p>14´00€</p>	<p>Conexiones: 10/32" Aire o Agua</p>
	<p>Válvula cartucho selector con palanca gris, 3 vías, liberación rápida</p> <p>Ref.: <b>VE-737</b></p> <p>28´80€</p>	<p>Conexiones: 10/32" Aire o Agua</p>
	<p>Válvula de regulación de caudal</p> <p>Ref.: <b>VE-581</b></p> <p>11´80€</p>	<p>Conexiones: 10/32" (1 puerto lateral / 1 puerto inferior) Aire o Agua</p>
	<p>Miniregulador presión de agua</p> <p>Ref.: <b>VE-582</b></p> <p>24´80€</p>	<p>Conexiones: 10/32" Incluye espigas 1,6mm Agua</p>
	<p>Válvula doble para jeringas 3F</p> <p>Ref.: <b>VE-583</b></p> <p>12´80€</p>	<p>Conexiones: 10/32" NO incluye espigas</p>
	<p>Válvula control dirección con palanca, 3 vías</p> <p>Ref.: <b>VE-738</b></p> <p>19´80€</p>	<p>Conexiones: 10/32" Aire o Agua</p>

# VÁLVULAS, ELECTROVÁLVULAS Y OTROS PARA SILLONES FEDESA®

Válvulas, electroválvulas y otros para sillones Fedesa®

RUMAR

	Descripción	Observaciones
NUEVO	 <p>Grupo distribuidor 3 instrumentos equipos Fedesa®</p> <p>Ref.: <b>FED-317A04</b> (Ref. Fedesa®: 317A04)</p>	<p>Repuesto relacionado: VE-7031</p> <p><b>98'00€*</b></p> <p>▶ <b>*Sin descuento</b></p>
	 <p>Membrana bloque 3 instrumentos, <b>tipo DCI (Ref.: VE-703)</b></p> <p>Ref.: <b>VE-7031</b> (Ref. Fedesa®: 317A02)</p>	<p>Repuesto compatible con bloques FED-317A04 (Ref. Fedesa® 317A02) y relacionado con VE-703</p> <p><b>14'80€</b></p>
NUEVO	 <p>Bloque 2 electroválvulas</p> <p>Ref.: <b>FED-054A05</b> (Ref. Fedesa®: 054A05)</p>	<p><b>80'00€*</b></p> <p>▶ <b>*Sin descuento</b></p> <p><b>Voltaje:</b> 24 V AC 50 Hz Repuestos relacionados: FED-237A12 y FED-237A03</p>
NUEVO	 <p>Bobina 5VA</p> <p>Ref.: <b>FED-237A14</b> (Ref. Fedesa®: 237A14)</p>	<p><b>12'80€*</b></p> <p>▶ <b>*Sin descuento</b></p> <p><b>Diámetro:</b> 9 mm <b>Voltaje:</b> 24 V AC Repuesto para bloque Fedesa Ref.: 054A05</p>
NUEVO	 <p>Bobina con núcleo</p> <p>Ref.: <b>FED-237A03</b> (Ref. Fedesa®: 237A03)</p>	<p><b>32'80€*</b></p> <p>▶ <b>*Sin descuento</b></p> <p>Repuesto para bloque Fedesa Ref.: 054A04</p>
NUEVO	 <p>Núcleo + guía latón EV agua</p> <p>Ref.: <b>FED-237A12</b> (Ref. Fedesa®: 237A12)</p>	<p><b>18'80€*</b></p> <p>▶ <b>*Sin descuento</b></p> <p>Repuesto para bloque Fedesa Ref.: 054A05</p>
NUEVO	 <p>Conjunto 24 V AC</p> <p>Ref.: <b>FED-054A04</b> (Ref. Fedesa®: 054A04)</p>	<p><b>23'80€*</b></p> <p>▶ <b>*Sin descuento</b></p> <p>Repuesto relacionado: FED-237A14</p>
NUEVO	 <p>Placa conexión 28 con junta</p> <p>Ref.: <b>FED-185A65</b> (Ref. Fedesa®: 185A65)</p>	<p><b>28'80€*</b></p> <p>▶ <b>*Sin descuento</b></p>
NUEVO	 <p>Filtro bronce</p> <p>Ref.: <b>FED-275A09</b> (Ref. Fedesa®: 275A09)</p>	<p><b>2'80€*</b></p> <p>▶ <b>*Sin descuento</b></p>







NUEVO		<p><b>Descripción</b></p> <p>Muelle Fedesa®</p> <p><b>Ref.: FED-575A70</b></p>	 <p>0<sup>80</sup>€*</p>	<p><b>Observaciones</b></p> <p>*Sin descuento</p>
		<p><b>Descripción</b></p> <p>Muelle Fedesa®</p> <p><b>Ref.: FED-575A55</b></p>		

## ELECTROVÁLVULAS SIRAI® / ASCO NEUMATICS®







Electroválvulas Sirai® / Asco Neumatics® / Emerson®



- SIRAI® / ASCO® / EMERSON®
- Primera calidad.
- Acabados y tolerancias según normas DIN.
- Garantía 3 meses.

	<b>Descripción</b>	<b>Observaciones</b>
	<p>Electroválvula escupidera 2 vías, normalmente cerrado Juntas Vitón <b>Aire o Agua</b></p> <p><b>Ref.: VE-L172011</b></p>	<p><b>Conexiones:</b> 2 x 1/8"</p> <p><b>Voltage:</b> 24V+/-10% AC / CA, 50/60 Hz.</p> <p><b>Potencia:</b> 3W</p> <p><b>Tº Fluido:</b> de 0°C a 130 °C</p> <p><b>Diámetro de paso:</b> 2,4mm</p> <p><b>Presión de trabajo (Aire/agua):</b> 0-13 bar</p> <p>48<sup>80</sup>€</p>
	<p>Electroválvula escupidera 2 vías, normalmente cerrado Juntas Vitón <b>Aire o Agua</b></p> <p><b>Ref.: VE-L172012</b></p>	<p><b>Conexiones:</b> 2 x 1/8"</p> <p><b>Voltage:</b> 24V+/-10% DC / CC</p> <p><b>Potencia:</b> 3,5W</p> <p><b>Tº Fluido:</b> de 0°C a 130 °C</p> <p><b>Diámetro de paso:</b> 2,4mm</p> <p><b>Presión de trabajo (Aire/agua):</b> 0-4 bar</p> <p>48<sup>80</sup>€</p>
	<p>Electroválvula colibrí / ultrasonidos 2 vías, V165V01, normalmente cerrado Juntas Vitón <b>Aire o Agua</b></p> <p><b>Ref.: VE-V165012</b></p>	<p><b>Conexiones:</b> 2 x M5</p> <p><b>Voltage:</b> 24V+/-10% DC / CC</p> <p><b>Potencia:</b> 4W</p> <p><b>Tº Fluido:</b> de 0°C a 130 °C</p> <p><b>Diámetro de paso:</b> 2,0mm</p> <p><b>Presión de trabajo (Aire/agua):</b> 0-4 bar</p> <p><b>Presión máxima admisible:</b> 16 bar</p> <p>50<sup>80</sup>€</p>
	<p>Electroválvula V124D03, normalmente cerrado Juntas EPDM <b>Aire y Agua</b></p> <p><b>Ref.: VE-V124012</b></p>	<p><b>Conexiones:</b> Especial</p> <p><b>Voltage:</b> 24V+/-10% DC / CC</p> <p><b>Potencia:</b> 4W</p> <p><b>Tº Fluido:</b> de -10°C a 100 °C</p> <p><b>Presión de trabajo (Aire/agua):</b> 0-6 bar</p> <p><b>Presión máxima admisible:</b> 16 bar</p> <p>56<sup>80</sup>€</p>
	<p>Electroválvula entrada 2 vías, normalmente cerrado Juntas Vitón <b>Aire, agua o vapor</b></p> <p><b>Ref.: VE-L121012</b></p>	<p><b>Conexiones:</b> 2 x 1/4"</p> <p><b>Voltage:</b> 24V+/-10% DC / CC</p> <p><b>Potencia:</b> 5W</p> <p><b>Tº Fluido:</b> de 0°C a 130 °C</p> <p><b>Diámetro de paso:</b> 4,5mm</p> <p><b>Presión de trabajo (Aire/agua):</b> 0-3 bar</p> <p>65<sup>80</sup>€</p>
	<p>Electroválvula entrada 2 vías, normalmente cerrado Juntas Vitón <b>Aire, agua o vapor</b></p> <p><b>Ref.: VE-L121013</b></p>	<p><b>Conexiones:</b> 2 x 1/4"</p> <p><b>Voltage:</b> 230V+/-10% AC / CA 50Hz.</p> <p><b>Potencia:</b> 9W</p> <p><b>Tº Fluido:</b> de 0°C a 130 °C</p> <p><b>Diámetro de paso:</b> 4,5mm</p> <p><b>Presión de trabajo (Aire/agua):</b> 0-8 bar</p> <p>65<sup>80</sup>€</p>

SI NO ENCUENTRAS EL REPUESTO QUE BUSCAS, ¡CONSÚLTANOS!  
Precios: impuestos, portes y mano de obra no incluidos.

	Descripción	Observaciones
	<p>Electrovalvula entrada, 3 vias, universal Juntas Vitón <b>Aire, agua o vapor</b></p> <p>Ref.: <b>VE-L321012</b></p>	<p><b>Conexiones:</b> 2 x 1/4" + 1 x 1/8" <b>Voltage:</b> 24V+/-10% DC / CC <b>Potencia:</b> 9W <b>Tª Fluido:</b> de 0°C a 130 °C <b>Diámetro de paso:</b> 2,3mm <b>Presión de trabajo (Aire/agua):</b> 0-5 bar</p> <p><b>98<sup>00</sup>€</b></p>
	<p>Electrovalvula V162B02, normalmente cerrado Juntas Nitrilo <b>Aire o Agua</b></p> <p>Ref.: <b>VE-V162012</b></p>	<p><b>Conexiones:</b> 2 x M5 <b>Voltage:</b> 24V+/-10% DC / CC <b>Potencia:</b> 4W <b>Tª Fluido:</b> de 0°C a 90 °C <b>Diámetro de paso:</b> 2,4mm <b>Presión de trabajo (Aire/agua):</b> 0-2 bar <b>Presión máxima admisible:</b> 16 bar</p> <p><b>62<sup>80</sup>€</b></p>
	<p>Electrovalvula 2 vias V164B02, proporcional, normalmente cerrado Juntas Nitrilo <b>Aire o Agua</b> Antigua V164B05</p> <p>Ref.: <b>VE-V164012</b></p>	<p><b>Conexiones:</b> 2 x M5 <b>Voltage:</b> 12-24V+/-10% DC / CC <b>Potencia:</b> 4W <b>Tª Fluido:</b> de -10°C a 90 °C <b>Diámetro de paso:</b> 1,6 mm <b>Presión de trabajo (Aire/agua):</b> 0-5 bar <b>Presión máxima admisible:</b> 16 bar</p> <p><b>114<sup>80</sup>€</b></p>
	<p>Electrovalvula 2 vias, L194D01, normalmente cerrado, proporcional Juntas Vitón <b>Aire o Agua</b> <b>Usada en sillones Cefia entre otros (hay que aprovechar los conectores del anterior)</b></p> <p>Ref.: <b>VE-L194012</b></p>	<p><b>Conexiones:</b> 1 x 1,8" + 1 x 1,6mm <b>Voltage:</b> 24V+/-10% DC / CC <b>Potencia:</b> 5,5W <b>Tª Fluido:</b> de 0°C a 130 °C <b>Diámetro de paso:</b> 1,6mm <b>Presión de trabajo (Aire/agua):</b> 0-6 bar <b>Presión máxima admisible:</b> 50 bar</p> <p><b>111<sup>80</sup>€</b></p>
	<p>Grupo 3 microactuariales, V625D01, normalmente cerrado Juntas EPDM <b>Aire o Agua</b> <b>Usada en sillones Vitali entre otros</b></p> <p>Ref.: <b>VE-V625012</b></p>	<p><b>Conexiones:</b> 3 x 1,6mm <b>Voltage:</b> 12-24V+/-10% DC / CC <b>Potencia:</b> 4W <b>Tª Fluido:</b> de -10°C a 90 °C <b>Diámetro de paso:</b> 1,6mm <b>Presión de trabajo (Aire/agua):</b> 0-6 bar <b>Presión máxima admisible:</b> 8 bar</p> <p><b>188<sup>00</sup>€</b></p>
	<p>Kit reparación para válvula ASCO V625D1</p> <p>Ref.: <b>VE-G3144801</b></p>	<p><b>Incluye:</b> Cabezal alimentación, cabezal lateral final, tornillo, anillo tórico y pin.</p> <p><b>45<sup>80</sup>€</b></p>

## VÁLVULAS ELECTRONEUMÁTICAS

Válvulas electroneumáticas RUMAR®

RUMAR

- Primera calidad.
- Acabados y tolerancias según normas DIN.
- Garantía 3 meses.

	Descripción	Observaciones
	<p>Micro electroneumático</p> <p>Ref.: <b>VE-580</b></p>	<p><b>Conexiones:</b> 10/32"</p> <p><b>Info Técnica:</b> 15A, 1/2 HP 125-250V AC / CA 50Hz. 0,6A 125V DC / CC 0,3A 250V DC / CC</p> <p><b>Estado:</b> Normalmente cerrada <b>Incluye:</b> espiga de 10/32" x 4,6mm</p> <p><b>22<sup>80</sup>€</b></p>



RPD









## ▶ **REGULADORES DE PRESIÓN Y REPUESTOS DEPÓSITOS DE AGUA DESTILADA**

- Reguladores y accesorios
- Repuestos depósito agua destilada

# REGULADORES Y ACCESORIOS

## Reguladores de presión

RUMAR



	Descripción	Observaciones
	Regulador de presión de aire con tuerca y manómetro <b>Presiones:</b> 0 - 8 bar (15 bar máx.) <b>Conexiones:</b> 1/4" hembra / hembra <b>Caudal:</b> 600 l/min  <b>Ref.: 54-263</b> (Ref. Fedesa®: 2110D + 415A07)	<b>Manómetro</b> de 40mm  Para (Ref. Fedesa® 2108D añadir racores en sección Racorería)
	Regulador de presión de aire con filtro de agua y manómetro (cuerpo y base fundición de Zinc) <b>Presiones:</b> 0 - 16 bar <b>Conexiones:</b> 1/4" hembra / hembra <b>Caudal:</b> 240 l/min  <b>Ref.: 54-261</b>	<b>Manómetro</b> de 40mm
<b>NUEVO</b> 	Regulador de presión de agua con tuerca y manómetro <b>Presiones:</b> 0 - 8 bar (15 bar máx.) <b>Conexiones:</b> 1/4" hembra / hembra  <b>Ref.: 54-264</b>	<b>Manómetro</b> de 40mm  (Ref. Fedesa® 2112D + 415A07) (Ref. Fedesa® 2109D*) *Racorería ver sección Racorería
	Manómetro de 40mm <b>Presiones:</b> 0 - 12 bar <b>Conexiones:</b> 1/8" MTG  <b>Ref.: 54-272</b>	<b>5'90€</b>
<b>NUEVO</b> 	Filtro aire completo <b>Presiones:</b> 15 bar máx. <b>Conexiones:</b> 1/4" hembra / hembra <b>Caudal:</b> 800 l/min  <b>Ref.: 54-265</b>	<b>Filtración:</b> 20 µm  (Ref. Fedesa® 275A08)
<b>NUEVO</b> 	Kit unión reguladores / filtros  <b>Ref.: 54-266</b>	<b>Compatible:</b> 54-263, 54-264, 54-265  <b>1'60€</b>
	Filtro aire completo <b>Presiones:</b> 7 bar máx. <b>Conexiones:</b> 1/8" hembra / hembra  <b>Ref.: 54-604800</b> (Ref. Faro®: 224800)	<b>Compatible con unión:</b> 54-604803  <b>38'80€</b>
	Regulador presión de aire <b>Presiones:</b> 0 - 6 bar (10 bar máx.) <b>Conexiones:</b> 1/8" hembra / hembra <b>Caudal:</b> 250 l/min  <b>Ref.: 54-604801</b> (Ref. Faro®: 224801)	<b>Compatible con unión:</b> 54-604803  <b>38'80€</b>
	Manómetro de 25mm <b>Presiones:</b> 0 - 12 bar <b>Conexiones:</b> 1/8" MTG  <b>Ref.: 54-604802</b> (Ref. Faro®: 224802)	<b>21'80€</b>

HASTA AGOTAR

	Filtro agua completo <b>Presiones:</b> 7 bar máx <b>Conexiones:</b> 1/8" hembra/hembra	Compatible con unión: 54-604803
	<b>Ref.: 54-604805</b> (Ref. Faro®: 224805)	40 <sup>80</sup> €
	Regulador de presión de agua <b>Presiones:</b> 0 - 6 bar (10 bar máx.) <b>Conexiones:</b> 1/8" hembra / hembra	Compatible con unión: 54-604803
	<b>Ref.: 54-604806</b> (Ref. Faro®: 224806)	50 <sup>80</sup> €
	Unión reguladores / filtros	Compatible: 54-604800, 54-604801, 54-604805 y 54-604806
	<b>Ref.: 54-604803</b> (Ref. Faro®: 224803)	3 <sup>00</sup> €

### Accesorios reguladores de presión

RUMAR



	Descripción	Observaciones
	Escuadra-soporte regulador <b>Ref.: 54-270</b>	Para referencias: 54-263 y 54-261 2 <sup>70</sup> €
	Tuerca regulador <b>Ref.: 54-271</b>	Para referencias: 54-263 y 54-261 4 <sup>00</sup> €

HASTA AGOTAR

## REPUESTOS DEPÓSITOS DE AGUA DESTILADA

### Repuestos depósitos de agua destilada





RUMAR

	Descripción	Observaciones
	Conector rápido entrada <b>Ref.: 52-205</b>	Color: Gris Sin adaptador 16 <sup>80</sup> €
	Conector rápido salida <b>Ref.: 52-206</b>	Color: Negro Sin adaptador 16 <sup>80</sup> €

SÓLO ASEGURAMOS COMPATIBILIDAD CON LOS TANQUES DE AGUA DESTILADA DE RUMAR®

SI NO ENCUENTRAS EL REPUESTO QUE BUSCAS, ¡CONSÚLTANOS!  
Precios: impuestos, portes y mano de obra no incluidos.

RUMAR 267

	Descripción	Observaciones
	Anillos tóricos conectores  <b>Ref.: 52-213</b>	<b>0'90€</b>
	Conector entrada  <b>Ref.: 52-214</b>	<b>14'80€</b>
	Conector salida  <b>Ref.: 52-215</b>	<b>14'80€</b>
	Tubo interno líquido  <b>Ref.: 52-216</b>	<b>8'00€</b>

SÓLO ASEGURAMOS COMPATIBILIDAD CON LOS TANQUES DE AGUA DESTILADA DE RUMAR®

H







## ▶ HERRAMIENTAS

- Herramientas instrumental rotatorio
- Herramientas equipos

# Llaves Tapa / Botón Turbinas









Llaves Tapa / Botón Turbinas KaVo®

RUMAR

	Descripción	Observaciones
	<p><b>Lado A (4 muescas):</b>                      COMPACTtorque® 636                      GENTLEforce® 6000                      GENTLEforce® 7000                      GENTLEsilence® 8000</p> <p><b>Lado B y Lado C ver sección llaves MK-dent®</b></p> <p>MASTERtorque® M9000                      MASTERtorque® M9000L                      SMARTtorque® 609                      SMARTtorque® 619</p> <p>SUPERtorque® 650                      SUPERtorque® 655                      SUPERtorque® 660</p> <p>Ref.: <b>HE-620</b></p>	<p>Llave triple</p> <p><b>29<sup>80</sup>€</b></p>
	<p>SMARTtorque® 609                      SMARTtorque® 619                      COMPACTtorque® 636                      SUPERtorque® 650</p> <p>SUPERtorque® 655                      SUPERtorque® 660                      GENTLEforce® 6000                      GENTLEforce® 7000</p> <p>GENTLEsilence® 8000                      MASTERtorque® M9000                      MASTERtorque® M9000L</p> <p>Ref.: <b>HE-1650T</b></p>	<p><b>43<sup>80</sup>€</b></p>
	<p><b>Lado A (4 puntos):</b>                      SMARTtorque® 609                      SMARTtorque® 619                      COMPACTtorque® 636                      SUPERtorque® 650</p> <p><b>Lado B (3 puntos):</b>                      SMARTtorque Mini® S605                      SMARTtorque Lux® S615                      EXPERTtorque Mini® E677</p> <p>SUPERtorque® 655                      SUPERtorque® 660                      EXPERTtorque® E680                      EXPERTtorque® E679</p> <p>EXPERTtorque Mini Lux® E675                      GENTLEforce® 4500                      GENTLEforce® 5000</p> <p>GENTLEforce® 6000                      GENTLEforce® 7000                      GENTLEsilence® 8000                      MASTERtorque® M9000</p> <p>Ref.: <b>HE-604</b></p>	<p>Llave doble</p> <p><b>23<sup>80</sup>€</b></p>
	<p>SUPERtorque® 630                      BELLAtorque® 639                      BELLAtorque® 642</p> <p>BELLAtorque® 645                      SUPERtorque® 640</p> <p>Ref.: <b>HE-609</b></p>	<p><b>34<sup>80</sup>€</b></p>
	<p>MIRAlux® 635                      MIRAtorque mini® 637</p> <p>Ref.: <b>HE-1637T</b></p>	<p><b>43<sup>80</sup>€</b></p>
	<p>Punta para llave HE-751 para tapa turbinas</p> <p>SMARTtorque® 609                      SMARTtorque® 619                      COMPACTtorque® 636                      SUPERtorque® 650</p> <p>SUPERtorque® 655                      SUPERtorque® 660                      GENTLEforce® 6000                      GENTLEforce® 7000</p> <p>GENTLEsilence® 8000                      MASTERtorque® M9000                      MASTERtorque® M9000L</p> <p>Ref.: <b>HE-756</b></p>	<p><b>13<sup>80</sup>€</b></p>
	<p>Punta para llave HE-751 para tapa turbinas</p> <p><b>Lado B (3 puntos):</b>                      SMARTtorque Mini® S605                      SMARTtorque Lux® S615                      EXPERTtorque Mini® E677</p> <p>EXPERTtorque Mini Lux® E675                      GENTLEforce® 4500                      GENTLEforce® 5000</p> <p>Ref.: <b>HE-755</b></p>	<p><b>13<sup>80</sup>€</b></p>

	Descripción	Observaciones
	<p><b>Lado A (4 muescas):</b>                      HE12 HC4021                      HE15 HC5021                      HE17 (HE010000&lt;N/S&lt;HE023799) HC6021 (A partir Serie F)                      HE21 HC7021</p> <p><b>Lado B (4 lados):</b>                      HE14 HC4012 HC6022                      HE18 HC4022 HC7022                      HE22 HC5022 HC8022                      HP22 HC6012 HC9022</p> <p><b>Lado C (4 lados):</b>                      HC2012 (Desde Serie F)                      HC4011</p> <p><b>Ref.: HE-620</b></p>	<p>Llave triple</p> <p><b>29'80€</b></p>
 <small>Imagen no disponible</small>	<p>HP21 (N/S&lt;05) HC8021 HE15 HE15L                      HC21 HC9021 HB12                      HE21 (N/S&lt;05) HE17 (HE010000&lt;N/S&lt;HE023799) HE11 HE12</p> <p><b>Ref.: HE-1650T</b></p>	<p>Utilizable con llaves dinamométrica HE-2025 y HE-2026.</p> <p><b>*Comprobar que tapa tiene 4 muescas de contacto*</b></p> <p><b>33'80€</b></p>
 <small>Imagen no disponible</small>	<p>HC20 HE17 (N/S&gt;HE023800)                      HP21 (N/S&gt;05)                      HC21 (N/S&gt;05)</p> <p><b>Ref.: HE-1651T</b></p>	<p>Utilizable con llaves dinamométrica HE-2025 y HE-2026.</p> <p><b>*Comprobar que tapa tiene 4 lados de contacto*</b></p> <p><b>43'80€</b></p>

▶ Llaves Tapa / Botón Turbinas **W&H®**

	Descripción	Observaciones
	Cabezas mini (Excepto Alegra® TE-97 / Alegra® TE-98)  <b>Ref.: HE-1096W</b>	2 muescas  29'80€
	Synea® TA-98  <b>Ref.: HE-840</b>	2 muescas  39'80€
	<b>Lado A (3 muescas):</b> Synea® TA-97 Alegra® TE-97  <b>Ref.: HE-602</b>	<b>Lado B (3 muescas):</b> Synea® TA-98 LED Synea Fusion® TG-98  Llave doble  23'80€
	Alegra® TE-98 Alegra® TE-95 Trend® TC80BC Trend® TC-95BC  <b>Ref.: HE-606</b>	Trend 398 Trend 698 Trend 795  Trend 798 Trend 895 Trend 898  2 muescas  39'80€
 <small>Imagen no disponible</small>	196 796 896  <b>Ref.: HE-836</b>	2 muescas  39'80€
	RC-95RM  <b>Ref.: HE-929</b>	Incorpora saca golpes en parte delantera  28'00€
	<b>Lado A (Hexagonal):</b> Alegra® HS2014 TE97  <b>Ref.: HE-610</b>	<b>Lado B (cuadrada):</b>  Ver sección NSK® para otros modelos Ver sección Sirona® para otros modelos  Llave doble  39'80€
	<b>Lado A (Hexagonal):</b> Alegra® HS2014 TE95 Alegra® HS2014 TE98  <b>Ref.: HE-829</b>	<b>Lado B (Hexagonal):</b> Alegra® HS2014 TE97  Llave doble  23'80€
	Synea® Vision TK-100 Synea® Vision TK-94  <b>Ref.: HE-619</b>	3 Muecas  23'80€





BAJO PEDIDO

NUEVO





NUEVO







Llaves Tapa / Botón Turbinas **Bien Air®**

	Descripción	Observaciones
	<p><b>Lado A (2 puntos):</b> Tapa Interna / Bisel Bora* Tapa Interna / Bisel Croma Tapa Interna / Bisel Boralina <b>*Excepto Bora 2</b></p> <p><b>Lado B (2 puntos):</b> Tapa externa Bora* Tapa externa Croma Tapa externa Boralina</p> <p>Ref.: <b>HE-802</b></p>	<p>Llave doble</p> <p><b>39<sup>80</sup>€</b></p>
	<p>Bora 2</p> <p>Ref.: <b>HE-618</b></p>	<p><b>39<sup>80</sup>€</b></p>
	<p><b>Lado A:</b> Interna y externa Prestige</p> <p><b>Lado B:</b> Externa Ondine</p> <p>Ref.: <b>HE-803</b></p>	<p>Llave doble</p> <p><b>39<sup>80</sup>€</b></p>
	<p>Tornado (N/S&lt;16E0001)</p> <p>Ref.: <b>HE-831</b></p>	<p><b>39<sup>80</sup>€</b></p>
	<p>Tornado S (cabeza mini)</p> <p>Ref.: <b>HE-846</b></p>	<p><b>39<sup>80</sup>€</b></p>



Llaves Tapa / Botón Turbinas **Sirona®**



	Descripción	Observaciones
	<p>T1 Control T2 Control T3 Control</p> <p>Racer Mini Siroboost</p> <p>Ref.: <b>HE-591</b></p>	<p>Llave triple 2 muescas</p> <p><b>18<sup>80</sup>€</b></p>
	<p><b>Lado A: (3 muescas)</b> T1 Control</p> <p><b>Lado B: (3 muescas)</b> Mini</p> <p>Ref.: <b>HE-592</b></p>	<p>Llave doble</p> <p><b>18<sup>80</sup>€</b></p>
	<p>T1 Boost (N/S&gt;600.000) T2 Boost (N/S&gt;600.000) T3 Boost (N/S&gt;600.000)</p> <p>Ref.: <b>HE-612</b></p>	<p>3 muescas</p> <p><b>39<sup>80</sup>€</b></p>
	<p>T1 Boost (N/S&gt;800.000) T2 Boost (N/S&gt;800.000) T3 Boost (N/S&gt;800.000)</p> <p>Ref.: <b>HE-617</b></p>	<p>3 muescas</p> <p><b>39<sup>80</sup>€</b></p>

▶ Llaves Tapa / Botón Turbinas **Castellini®**

	Descripción	Observaciones
	Hi Power M Clean Air  <b>Ref.: HE-800</b>	35'80€
	Silent Power Gold Silent Power Gold M Hi Power Light  <b>Ref.: HE-810</b>	35'80€
	Silent Power <b>EVO</b> 2 Silent Power <b>EVO</b> 2L Silent Power <b>EVO</b> 4L Silent Power <b>EVO</b> 4LK  <b>Ref.: HE-822</b>	34'80€
	Silent Power EVO Miniature Silent Power EVO Miniature K  <b>Ref.: HE-823</b>	34'80€
	Silent Power <b>Silver</b> 2 Silent Power <b>Silver</b> 2L Silent Power <b>Silver</b> 4L Silent Power <b>Silver</b> 4LK  <b>Ref.: HE-824</b>	34'80€

▶ Llaves Tapa / Botón Turbinas **NSK®**

	Descripción		Observaciones
	<b>Lado A (11,30mm octogonal):</b> Ti-Max X500* Ti-Max X500*L NL9000M Pana Max TUM4  <b>Ref.: HE-008</b>	<b>Lado B (10,00mm octogonal):</b> Pana Air Rainbow	Llave doble *: K, S, W, B  12'40€ <span style="float: right; background-color: yellow; padding: 2px;">HASTA AGOTAR</span>
	Ti-Max NL95M Ti-Max A500*L Ti-Max A500*	Pana Air	Medidas: 9,60 mm octogonal *: K, S, W, B  12'40€
	<b>Lado A (12,30 mm hexagonal)</b> Rainbow Nuevo modelo	<b>Lado B (10,90 mm hexagonal)</b>	Llave doble  14'80€ <span style="float: right; background-color: yellow; padding: 2px;">HASTA AGOTAR</span>
	<b>Lado A (Octogonal):</b> S-Max M600* S-Max M600*L	<b>Lado B (Octogonal):</b> Pico	Llave doble *: K, S, W, B  18'80€

	Descripción	Observaciones
	<p><b>Lado A (10,60 mm octogonal):</b>                      Ti-Max NL 45S                      Ti-Max NL 45T                      Ti-Max NL 95T                      Ti-Max NL95 S                      Ti-Max A600*                      Ti-Max A600*L                      Ti-Max A300*                      Ti-Max A300*L                      Ti-Max A450*                      Ti-Max A450*L</p> <p><b>Lado B (10,95 mm octogonal):</b>                      Ti-Max A700*                      Ti-Max A700*L                      Phatelus 45 S                      Phatelus 45 SU                      Phatelus II S                      Phatelus II SU                      Ti-Max NL75 Mach Light S                      NL85 Mach Light                      NL65S Mach Light                      Mach Lite XT S                      Mach Lite XT SU</p> <p><b>Lado B (10,95 mm octogonal):</b>                      Ti-Max X600*                      Ti-Max X600*L                      Ti-Max NL9000*S                      Pana-Max 2</p> <p><b>Ref.: HE-600</b> <span style="float: right;"><b>23<sup>80</sup>€</b></span></p>	<p>Llave doble                      *: K, S, W, B</p>
	<p><b>Lado A (12,90mm octogonal):</b>                      Ti-Max X700*L                      Ti-Max X700*                      Ti-Max NL9000*T</p> <p><b>Lado B (11,30mm octogonal):</b>                      Ti-Max X500*L                      Ti-Max X500*                      Ti-Max NL9000M</p> <p><b>Lado C (10,95 mm octogonal):</b>                      Ti-Max X600*                      Ti-Max X600*L                      Ti-Max NL9000*S</p> <p><b>Ref.: HE-605</b> <span style="float: right;"><b>23<sup>80</sup>€</b></span></p>	<p>Llave triple                      *: K, S, W, B</p>
	<p><b>Lado A (3 muescas):</b>                      Ti-Max Z800</p> <p><b>Lado B (3 muescas):</b>                      Ti-Max Z900</p> <p><b>Ref.: HE-614</b> <span style="float: right;"><b>23<sup>80</sup>€</b></span></p>	<p>Llave doble</p>

Llaves Tapa-Botón Turbinas Chirana®

RUMAR



	Descripción	Observaciones
	<p>TG-656                      TG-637A (smile - music)</p> <p><b>Ref.: HE-609</b> <span style="float: right;"><b>34<sup>80</sup>€</b></span></p>	

Llaves Multiusos

RUMAR

	Descripción	Observaciones
	<p><b>Lado A (9,60 mm hexagonal)</b>  <b>Lado B (8,10mm cuadrada)</b>  <b>Lado C (10,20 mm cuadrada)</b>  <b>Lado D (4 puntos)</b></p> <p><b>Ref.: HE-603</b> <span style="float: right;"><b>12<sup>40</sup>€</b></span></p>	



Llaves Tapa / Botón Turbinas RUMAR®

	Descripción	Observaciones
	<p>ECO T2 ECO T3 L PRO T1L</p> <p><b>Ref.: HE-252K</b></p>	<p>4'80€</p>
	<p>ECO T TURBO</p> <p><b>Ref.: HE-253K</b></p>	<p>4'80€</p>

## LLAVES TAPAS DE SPRAY TURBINAS

### ▶ Llaves tapas de spray turbinas **KaVo®**

RUMAR

	Descripción			Observaciones
	SUPERtorque® 630 SUPERtorque® 640 BELLAtorque® 645	SUPERtorque® 647B SUPERtorque® 655 SUPERtorque® 660		Utilizable con llaves dinamométricas HE-2025 y HE-2026
	<b>Ref.: HE-1022KT</b>		<b>43'80€</b>	
<b>NUEVO</b>		SUPERtorque® 630 SUPERtorque® 640 BELLAtorque® 645	SUPERtorque® 647B SUPERtorque® 650	SUPERtorque® 655 SUPERtorque® 660
	<b>Ref.: HE-621</b>		<b>14'80€</b>	



### ▶ Llaves tapas de spray turbinas **RUMAR®**

RUMAR

	Descripción	Observaciones
	PowerMax	
	<b>Ref.: HE-629</b>	<b>19'60€</b>

### ▶ Llaves tapas de spray turbinas **MK-dent®**









RUMAR

	Descripción			Observaciones
	Todos los modelos con 3-Spray hasta N/S: G			Utilizable con llaves dinamométricas HE-2025 y HE-2026
	<b>Ref.: HE-1022KT</b>		<b>43'80€</b>	
	HC17 HC20 HC21	HC8021 HC9021	HE21 HP21	
<b>V</b>	<b>Ref.: HE-1922</b>		<b>27'80€</b>	

# SACA GOLPES CABEZAS

Saca golpes cabezas

RUMAR

	Descripción	Observaciones
	<p><b>Bien Air® Bora</b></p> <p>Ref.: <b>HE-920</b> <span style="float: right;"><b>28<sup>00</sup>€</b></span></p>	
	<p><b>Bien Air® Black Pearl</b></p> <p>Ref.: <b>HE-926</b> <span style="float: right;"><b>28<sup>00</sup>€</b></span></p>	
	<p><b>NSK® Ti-Max X600</b></p> <p>Ref.: <b>HE-921</b> <span style="float: right;"><b>28<sup>00</sup>€</b></span></p>	<p>Incorpora llave tapa en parte trasera</p>
	<p><b>NSK® S-Max M600</b></p> <p>Ref.: <b>HE-927</b> <span style="float: right;"><b>28<sup>00</sup>€</b></span></p>	<p>Incorpora llave tapa en parte trasera</p>
	<p><b>NSK® Ti-Max Z900</b></p> <p>Ref.: <b>HE-928</b> <span style="float: right;"><b>28<sup>00</sup>€</b></span></p>	<p>Incorpora llave tapa en parte trasera</p>
	<p><b>KaVo® BELLAtorque® 642</b></p> <p>Ref.: <b>HE-922</b> <span style="float: right;"><b>28<sup>00</sup>€</b></span></p>	<p>Incorpora llave tapa en parte trasera</p>
	<p><b>KaVo® SUPERtorque® 655</b>  <b>KaVo® SUPERtorque® 650</b>  <b>KaVo® SUPERtorque® 660</b></p> <p><b>KaVo® GENTLEforce® 7000</b>  <b>KaVo® GENTLEforce® 8000</b></p> <p>Ref.: <b>HE-925</b> <span style="float: right;"><b>28<sup>00</sup>€</b></span></p>	
	<p><b>W&amp;H® RC-95RM</b></p> <p>Ref.: <b>HE-929</b> <span style="float: right;"><b>28<sup>00</sup>€</b></span></p>	<p>Incorpora llave tapa en parte trasera</p>
	<p><b>W&amp;H® Synea® TA-98 LED</b></p> <p>Ref.: <b>HE-923</b> <span style="float: right;"><b>28<sup>00</sup>€</b></span></p>	<p>Incorpora llave tapa en parte trasera</p>

NUEVO



W&H® Synea® TA-98







Ref.: HE-924













28<sup>00</sup>€

## LLAVES PARA CONTRA-ÁNGULOS y PIEZAS DE MANO

▶ Llaves para contra-ángulos y piezas de mano **KaVo®**











RUMAR

	Descripción	Observaciones
	<p>INTRAmatic® 25LH INTRAmatic® 25LHS INTRAmatic® 25CN INTRAmatic® 25CH</p> <p>INTRAmatic® 25LS INTRAmatic® LUX 24LN INTRAmatic® LUX 24LS</p> <p>Ref.: HE-817</p>	<p>34<sup>80</sup>€</p>
	<p>EXPERTmatic® E25 EXPERTmatic® E25L</p> <p>Ref.: HE-819 (Ref. Kavo®: 1.008.2377)</p>	<p>23<sup>80</sup>€</p>
	<p><b>Lado A (2 lados rectos):</b> INTRA lux® 67LDN INTRA lux® 68LDN</p> <p><b>Lado B (3 puntos):</b> INTRA lux® L67 INTRA lux® L68 INTRA lux® 67LH INTRA lux® 68LH</p> <p>EXPERTmatic® E20L INTRAcompact® 2068LHC INTRAcompact® 2068CHC</p> <p>Ref.: HE-751</p>	<p>Llave doble</p> <p>49<sup>80</sup>€</p>
	<p><b>Punta para llave HE-751 para tapa cabezas:</b> INTRA lux® 67LDN INTRA lux® 68LDN</p> <p>Ref.: HE-753LDN</p>	<p>2 lados rectos</p> <p>13<sup>80</sup>€</p>
	<p><b>Punta para llave HE-751 para tapa cabezas:</b> INTRA lux® L67 INTRA lux® L68 INTRA lux® 67LH</p> <p>INTRA lux® 68LH EXPERTmatic® E20L INTRAcompact® 2068LHC INTRAcompact® 2068CHC</p> <p>Ref.: HE-753LH</p>	<p>3 puntos</p> <p>13<sup>80</sup>€</p>
<p>NUEVO</p>		<p><b>Punta para llave HE-751 para tornillo:</b> 0.201.0005 Cabezas KaVo® SP2021 Cabezas MK-dent®</p> <p>Ref.: HE-753TOR</p> <p>11<sup>80</sup>€</p>
	<p>INTRA lux® CL3</p> <p>Ref.: HE-832 (Ref. KaVo®: 0.540.4012)</p>	<p>39<sup>80</sup>€</p>

	Descripción	Observaciones
	<p><b>Lado A (8 puntos):</b> MASTERmatic® LUX M05L</p> <p><b>Lado B (12 puntos):</b> Tapa compatible BVT-448</p> <p><b>Ref.: HE-850</b> (Ref. KaVo®: 3.001.3143)</p> <p><b>59<sup>80</sup>€</b></p>	
	<p>Mandril de montaje anillo de conducción 0.540.4072 Cabezas KaVo®</p> <p><b>Ref.: HE-752</b></p> <p><b>19<sup>80</sup>€</b></p>	
 <p> Wera</p>	<p>Destornillador hexagonal miniatura Wera para tornillo 0.201.0005. Cabezas KaVo®</p> <p><b>Ref.: HE-2016</b></p> <p><b>21<sup>80</sup>€</b></p>	
 <p> Wera</p>	<p>Destornillador miniatura Wera® plano</p> <p><b>Ref.: HE-2027</b></p> <p><b>19<sup>80</sup>€</b></p>	<p><b>Medidas:</b> 0,25x1,2x40 mm</p>
 <p> Wera</p>	<p>Destornillador miniatura Wera® plano</p> <p><b>Ref.: HE-2028</b></p> <p><b>19<sup>80</sup>€</b></p>	<p><b>Medidas:</b> 0,23x1,5x40 mm</p>
	<p>Placa especial para colocar y extraer rodamientos de cabezas de contra-ángulos KaVo®</p> <p><b>Ref.: HE-2013</b> (Ref. Kavov®: 0.410.0724)</p> <p><b>48<sup>80</sup>€</b></p>	<p><b>HASTA AGOTAR</b></p>
	<p>Llave anillo de cierre trasero contra ángulos y piezas de mano KaVo®</p> <p><b>Ref.: HE-2011BT</b> (Ref. KaVo®: 0.411.1881)</p> <p><b>39<sup>80</sup>€</b></p>	
	<p>Extractor especial desmontaje componentes interiores contra ángulos y piezas de mano KaVo®</p> <p><b>Ref.: HE-2015</b> (Ref. KaVo®: 0.411.4451)</p> <p><b>69<sup>80</sup>€</b></p>	
 <p>Imagen no disponible</p>	<p>Extractor pieza frontal contra ángulos KaVo®</p> <p><b>Ref.: HE-2012</b> (Ref. KaVo®: 0.411.2381)</p> <p><b>101<sup>80</sup>€</b></p>	



Llaves para contra-ángulos y piezas de mano **MK-dent®**

	Descripción	Observaciones								
	<p>Llave tapa cabezas contra ángulos</p> <table border="0"> <tr> <td>LCH11</td> <td>LS9011</td> </tr> <tr> <td>LCH21</td> <td>LS9021</td> </tr> <tr> <td>LPH11</td> <td>LS9111</td> </tr> <tr> <td>LPH21</td> <td>LS9121</td> </tr> </table> <p><b>Ref.: HE-2011T</b></p>	LCH11	LS9011	LCH21	LS9021	LPH11	LS9111	LPH21	LS9121	<p><b>48´00€</b></p>
LCH11	LS9011									
LCH21	LS9021									
LPH11	LS9111									
LPH21	LS9121									
	<p><b>Lado B (4 lados):</b> Llave tapa cabezas contra ángulos LS9016.</p> <p><b>Lado A y lado C, otras compatibilidades.</b> <b>Lado B</b> ver <b>sección llaves tapas turbina KaVo® y MK-dent®.</b></p> <p><b>Ref.: HE-620</b></p>	<p>Llave triple</p> <p><b>29´80€</b></p>								
	<p>Mandril de montaje anillo de conducción SP2007. Cabezas MK-dent®</p> <p><b>Ref.: HE-752</b></p>	<p><b>38´80€</b></p>								
 <p></p>	<p>Destornillador hexagonal miniatura Wera® para tornillo SP2021. Cabezas MK-dent®</p> <p><b>Ref.: HE-2016</b></p>	<p><b>21´80€</b></p>								
 <p></p>	<p>Destornillador miniatura Wera® plano</p> <p><b>Ref.: HE-2027</b></p>	<p>Medidas: 0,25x1,2x40 mm</p> <p><b>19´80€</b></p>								
 <p></p>	<p>Destornillador miniatura Wera® plano</p> <p><b>Ref.: HE-2028</b></p>	<p>Medidas: 0,23x1,5x40 mm</p> <p><b>19´80€</b></p>								
	<p>Placa especial para colocar y extraer rodamientos de cabezas de contra-ángulos MK-dent®</p> <p><b>Ref.: HE-2013</b></p>	<p><b>48´80€</b></p>								

Llaves para contra-ángulos y piezas de mano **W&H®**

	Descripción	Observaciones																
	<p><b>Lado A (2 Muestras) - Tapa-Botón cabeza contra ángulo:</b> (Ref. W&amp;H: C-1077)</p> <table border="0"> <tr> <td>Alegria® WE-56 (Rotor CON anillo azul)</td> <td>Alegria® WE-56LED</td> </tr> <tr> <td>Alegria® WE-56A (Rotor CON anillo azul)</td> <td>Alegria® WE-99A</td> </tr> <tr> <td>Alegria® WE-56E (Rotor CON anillo azul)</td> <td>Alegria® WE-99 LED G</td> </tr> <tr> <td>Alegria® WE-56 (Rotor SIN anillo azul)</td> <td>Fusion® WG-99LT (N/S-007801)</td> </tr> <tr> <td>Alegria® WE-56T (Rotor SIN anillo azul)</td> <td>Fusion® WG-99 LED G (N/S-007801)</td> </tr> </table> <p><b>Lado B (2 Muestras) - Eje cabeza contra ángulo:</b></p> <table border="0"> <tr> <td>Alegria® WE-56 (Rotor CON anillo azul)</td> <td>Alegria® WE-56T (Rotor SIN anillo azul)</td> </tr> <tr> <td>Alegria® WE-56E (Rotor CON anillo azul)</td> <td>Alegria® WE-56 LED</td> </tr> <tr> <td>Alegria® WE-56 (Rotor SIN anillo azul)</td> <td>Alegria® WE-56A</td> </tr> </table> <p><b>Ref.: HE-763</b></p>	Alegria® WE-56 (Rotor CON anillo azul)	Alegria® WE-56LED	Alegria® WE-56A (Rotor CON anillo azul)	Alegria® WE-99A	Alegria® WE-56E (Rotor CON anillo azul)	Alegria® WE-99 LED G	Alegria® WE-56 (Rotor SIN anillo azul)	Fusion® WG-99LT (N/S-007801)	Alegria® WE-56T (Rotor SIN anillo azul)	Fusion® WG-99 LED G (N/S-007801)	Alegria® WE-56 (Rotor CON anillo azul)	Alegria® WE-56T (Rotor SIN anillo azul)	Alegria® WE-56E (Rotor CON anillo azul)	Alegria® WE-56 LED	Alegria® WE-56 (Rotor SIN anillo azul)	Alegria® WE-56A	<p>Llave doble</p> <p><b>44´80€</b></p>
Alegria® WE-56 (Rotor CON anillo azul)	Alegria® WE-56LED																	
Alegria® WE-56A (Rotor CON anillo azul)	Alegria® WE-99A																	
Alegria® WE-56E (Rotor CON anillo azul)	Alegria® WE-99 LED G																	
Alegria® WE-56 (Rotor SIN anillo azul)	Fusion® WG-99LT (N/S-007801)																	
Alegria® WE-56T (Rotor SIN anillo azul)	Fusion® WG-99 LED G (N/S-007801)																	
Alegria® WE-56 (Rotor CON anillo azul)	Alegria® WE-56T (Rotor SIN anillo azul)																	
Alegria® WE-56E (Rotor CON anillo azul)	Alegria® WE-56 LED																	
Alegria® WE-56 (Rotor SIN anillo azul)	Alegria® WE-56A																	

	Descripción	Observaciones
	Synea® WA-99A (desde 2007) Synea® WA-99LT (desde 2007) Fusion® WG-99LT (N/S>007802) Vision® WK-99LT (N/S>01001)  <b>Ref.: HE-820</b>	<b>34´80€</b>
	Trend® WD-56 Synea® WA-56LT (hasta 2007) Synea® WA-99A/99LT (hasta 2007)  <b>Ref.: HE-842</b> (Ref. W&H®: C-549)	<b>39´80€</b>
	Synea® WA-56A (desde 2007) Synea® WA-56LT (desde 2007) Synea® WA-66LT (desde 2007)  <b>Ref.: HE-843</b> (Ref. W&H®: C-1046)	Vision® WK-56LT (todos N/S) Vision® WK-56S Fusion® WG-56LT (N/S>014633) Fusion® WG-56LT (N/S<014633)  <b>39´80€</b>
	WS-75 WS-75 E/KM (N/S<025335) WS-75 E/KM (N/S>30000)  <b>Ref.: HE-844</b> (Ref. W&H®: C-712)	WI-75 E/KM WI-75 LED G WS-75 LED G  <b>39´80€</b>
	Llave especial desmontaje eje intermedio WS-75 WD-56  Para modelos NSK®, ver sección NSK®  <b>Ref.: HE-950</b>	<b>38´80€</b>
	Llave anillo de cierre contra ángulos Fusión® WG-56A                      Fusión® WG-99A Fusión® WG-56A LT	<b>3 muescas</b> Contra ángulos sin fibra óptica  <b>Ref.: HE-622</b> <b>28´00€</b>
	<b>Lado A (3 Muestras) - Tapa cabeza contra ángulo:</b> Fusión® WG-56 <b>Lado B (2 Muestras) - Eje cabeza contra ángulo:</b> Fusión® WG-56  <b>Ref.: HE-623</b>	Llave doble  <b>28´00€</b>
	<b>Lado A (3 Muestras) - Tapa cabeza contra ángulo:</b> Fusión® WG-99 <b>Lado B (2 Muestras) - Eje cabeza contra ángulo:</b> Fusión® WG-99  <b>Ref.: HE-624</b>	Llave doble  <b>28´00€</b>
	Llave desmontaje pieza intermedia contra ángulos series: Fusión® WG-56                      Fusión® WG-99  <b>Ref.: HE-625</b>	<b>¡Advertencia!</b> Los dientes deben ser encajados correctamente para evitar rotura de llave y/o eje.  <b>28´00€</b>
	Llave desmontaje rodamientos ejes contra ángulos Fusión® WG-99  <b>Ref.: HE-626</b>	<b>28´00€</b>

NUEVO

NUEVO

NUEVO

NUEVO

NUEVO

NUEVO

NUEVO

	Descripción	Observaciones
	Llave cuerpo contra ángulo WE-xx LED G  <b>Ref.: HE-627</b> (Ref. W&H®: C-615, C-1081)	24'80€
	Llave anillo cierre contra ángulos WE-xx LED G  <b>Ref.: HE-628</b> (Ref. W&H®: C-411)	24'80€





▶ Llaves para contra-ángulos y piezas de mano **NSK®**

RUMAR

	Descripción	Observaciones
	<b>Lado A (hexagonal):</b> Para modelos NSK®, ver sección NSK®  <b>Ref.: HE-616</b>	<b>Lado B (dos puntos):</b> Eje WI-75 Para modelos NSK®, ver sección NSK®  34'80€
	<b>Lado A (hexagonal):</b> Tapa-Botón S-Max SG20 Tapa-Botón S-Max SG20L Tapa-Botón Ti-Max X-SG20L Tapa-Botón Ti-Max X-DSG20L  <b>Ref.: HE-616</b>	<b>Lado B (dos puntos):</b> Eje S-Max SG20 Eje S-Max SG20L Eje Ti-Max X-SG20L Eje Ti-Max X-DSG20L Para modelos W&H®, ver sección W&H®  34'80€
	<b>Lado A (hexagonal):</b> Ver sección W&H® para otros modelos  <b>Ref.: HE-610</b>	<b>Lado B (cuadrada):</b> Cabezas FPB-Y S-Max M25 S-Max M25L  Ti-Max Ti25 Ti-Max Ti25L Ti-Max X25 Ti-Max X25L  Ver sección Sirona® para otros modelos  39'80€
	Ti-Max Ti25 Ti-Max Ti25L  <b>Ref.: HE-613</b>	9'80€
	<b>Lado A (9,57mm hexagonal):</b> Ti-Max X95 Ti-Max X95L S-Max M95 S-Max M95L  <b>Ref.: HE-615</b>	<b>Lado B (8,65mm hexagonal):</b> Ti-Max Z95 Ti-Max Z95L  Llave doble  23'80€
	MP-F MPA-Y MPAS-Y  <b>Ref.: HE-611</b>	39'80€
	FX15 FX25 FX23  <b>Ref.: HE-839</b>	38'00€

	Descripción	Observaciones
	<p>Llave desmontaje eje central contra ángulos NSK®:                      S-Max M25L                      Ti-Max X25L                      Ti-Max Z25L                      S-Max M65L                      Ti-Max X65L                      Ti-Max Z95L                      S-Max M95L                      Ti-Max X95L</p> <p><b>Ref.: HE-2011BT</b> (Ref. KaVo®: 0.411.1881)</p>	<p><b>39'30€</b></p>

Llaves para contra-ángulos y piezas de mano **Sirona®** RUMAR



	Descripción	Observaciones
	<p><b>Lado A (hexagonal):</b>                      Ver sección W&amp;H® para otros modelos</p> <p><b>Lado B (cuadrada):</b>                      X-Smart 6:1                      Ver sección NSK® para otros modelos</p> <p><b>Ref.: HE-610</b></p>	<p>Llave doble</p> <p><b>39'80€</b></p>
 <small>Imagen no disponible</small>	<p>Dentsply X-Smart 16:1</p> <p><b>Ref.: HE-845</b></p>	<p><b>34'80€</b></p>
	<p>Alicate tapa cabezas contra ángulos Sirona® <b>standard</b></p> <p><b>Ref.: HE-818</b> (Ref. Sirona®: 4178054)</p>	<p><b>98'00€</b></p>
	<p>Alicate tapa cabezas contra ángulos Sirona® <b>mini</b></p> <p><b>Ref.: HE-821</b> (Ref. Sirona®: 5986208)</p>	<p><b>98'00€</b></p>
	<p>Alicate doble tapa cabezas contra ángulos Sirona® <b>mini y standard</b></p> <p><b>Ref.: HE-761</b></p>	<p>Alicate doble</p> <p><b>38'00€</b></p>

Llaves para contra-ángulos y piezas de mano **Bien Air®** RUMAR

	Descripción	Observaciones
 <small>Imagen no disponible</small>	<p>1:1                      1:1 L                      1:5 L                      20:1                      20:1 L</p> <p><b>Ref.: HE-849</b> (Ref. Bien Air®: 3600083)</p>	<p><b>39'80€</b></p>



▶ Llaves para contra-ángulos y piezas de mano **Castellini®**

RUMAR

Descripción	Observaciones
 <p>Goldspeed S1 Goldspeed SIL</p> <p><b>Ref.: HE-833</b></p>	<p><b>39<sup>80</sup>€</b></p> <p><b>BAJO PEDIDO</b></p>
 <p><b>Ref.: HE-834</b></p>	<p><b>39<sup>80</sup>€</b></p> <p><b>BAJO PEDIDO</b></p>

▶ Llaves para contra-ángulos y piezas de mano **Woodpecker®**





Descripción	Observaciones
 <p>Tapa-Botón WP-1 Tapa-Botón WP-1L</p> <p><b>Ref.: 28-CA005</b></p>	<p><b>13<sup>80</sup>€</b></p>
 <p>Kit reparación contra ángulo WP-1 WP-1L</p> <p><b>Incluye:</b></p> <ul style="list-style-type: none"> <li>1. Herramienta sujeción de cabeza.</li> <li>2. Punzón extractor caja transmisión.</li> <li>3. Llaves allen extracción cabezal (WP-1L).</li> <li>4. Llave tapa botón.</li> <li>5. Llave anillo de cierre trasero (WP-1L).</li> <li>6. Llave anillo de cierre trasero (WP-1).</li> <li>7. Soporte fibra extracción transmisión (WP-1L).</li> <li>8. Llave especial desmontaje eje intermedio (WP-1).</li> </ul> <p><b>Ref.: 28-CA006</b></p>	<p><b>80<sup>00</sup>€</b></p>

## LLAVES PARA MICROMOTORES



▶ Llaves para micromotores **MK-dent®**

RUMAR

Descripción	Observaciones
 <p>Llave apertura micromotor MK-dent® AM1116</p> <p><b>Ref.: HE-2014</b></p>	<p>Para anillo SPI060</p> <p><b>25<sup>80</sup>€</b></p>
 <p>Llave apertura micromotor MK-dent® AM1004</p> <p><b>Ref.: HE-2034</b></p>	<p><b>42<sup>80</sup>€</b></p>

▶ Llaves para micromotores modelo para TKD®







	Descripción	Observaciones
 	Llave apertura micromotores: TKD DEFINITIVE TKD VORTICE  <b>Ref.: HE-10010</b>	42 <sup>80</sup> €

## LLAVES ACOPLAMIENTOS

▶ Llaves para acoplamiento





	Descripción	Observaciones
 	Kavo® Multiflex MK-dent® QC4014K MK-dent® QC5016K  <b>Ref.: HE-1029</b>	8 <sup>00</sup> €
 	Mandril de desmontaje Kavo® Multiflex  <b>***Original KaVo***</b>  <b>Ref.: HE-911</b> (Ref. KaVo®: 411.3853)	MK-dent® QC4014K MK-dent® QC5016K  87 <sup>50</sup> €

LLAVES PARA MICROMOTORES NOUVAG® PREGÚNTANOS

# LLAVES PULIDORES BICARBONATO

▶ Llaves para pulidores bicarbonato

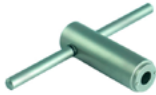
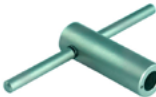
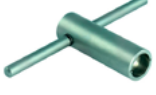
RUMAR

	Descripción	Observaciones
	MK-dent® PR1011 Micron Quick Jet BA Ultimate BA720  <b>Ref.: HE-2021K</b>	Sección acople KaVo®  <b>64<sup>80</sup>€</b>
	MK-dent® PR1011 Micron Quick Jet BA Ultimate BA720  <b>Ref.: HE-2021S</b>	Sección acople Sirona®  <b>64<sup>80</sup>€</b>
	MK-dent® PR1011 Micron Quick Jet BA Ultimate BA720  <b>Ref.: HE-2021W</b>	Sección acople W&H®  <b>64<sup>80</sup>€</b>
	MK-dent® PR1011 Micron Quick Jet BA Ultimate BA720  <b>Ref.: HE-2022</b>	Llave 1  <b>64<sup>80</sup>€</b>
	MK-dent® PR1011 Micron Quick Jet BA Ultimate BA720  <b>Ref.: HE-2023</b>	Llave 2  <b>64<sup>80</sup>€</b>

# HERRAMIENTAS DE MEDICIÓN Y DEMOSTRACIÓN

Herramientas de medición y demostración

RUMAR

## Descripción

## Observaciones

BAJADA  
PRECIO



**Dinamómetro digital** para medir la fuerza de retención de las pinzas de rotores de turbinas y contra ángulos multiplicadores

Ref.: HE-1020

68<sup>00</sup>€



WOODPECKER DTE

**Medidor digital de potencia de polimerización**

Mide tanto luces LED como halógenas hasta una intensidad de 3500mw/cm<sup>2</sup>

Ref.: 28-LM1

49<sup>80</sup>€

HASTA AGOTAR



MICRON

**Contador móvil de revoluciones y frecuencias:**

- Mide de 5.000 a 950.000 rpm.
- Mide frecuencias de 1 a 200.000 Hz.
- Display LED, numérica decimal.
- Medidas 76x118x18 mm.
- Peso 120 gr.
- Ideal para medir las rotaciones de cualquier instrumento rotatorio eléctrico o neumático y las frecuencias de cualquier ultrasonidos eléctrico o neumático.

Ref.: HE-100

1180<sup>00</sup>€



MICRON

**Fresa de turbina especial contador revoluciones** Ref.: 45-100

Ref.: HE-102

83<sup>00</sup>€

**Diámetro:** 1,6mm



MICRON

**Fresa de contra-ángulo especial contador revoluciones** Ref.: 45-100

Ref.: HE-103

83<sup>00</sup>€

**Diámetro:** 2,35mm



MICRON

**Magneto para puntas ultrasonido especial contador revoluciones** Ref.: 45-100

Ref.: HE-104

39<sup>80</sup>€



MICRON

**Sensor receptor especial contador revoluciones** Ref.: 45-100

Ref.: HE-105

148<sup>00</sup>€





RUMAR

**Microscopio de bolsillo con LED 60X**

Ref.: HE-754

31<sup>80</sup>€



















	Descripción	Observaciones
 <p>METASYS</p>	<p><b>Manómetro digital</b> Metasys® con adaptadores</p> <ul style="list-style-type: none"> <li>- Es un instrumento de medición para presiones negativas y aire comprimido.</li> <li>- Permite la medición exacta de la presión de aspiración, aire y agua en sillones dentales.</li> </ul> <p>Ref.: HE-050005</p> <p>388<sup>00</sup>€</p>	<p>Rango de presiones: -1 a 30 bar</p>
 <p>RUMAR</p>	<p><b>Multimanómetro</b> para medición de consumo de:</p> <ul style="list-style-type: none"> <li>- Aire de empuje</li> <li>- Aire de retorno</li> <li>- Aire de spray</li> <li>- Agua de spray</li> </ul> <ul style="list-style-type: none"> <li>- Conexión Midwest 4.</li> <li>- Mediciones precisas en bares.</li> <li>- Compacto.</li> <li>- Uso en todos los equipos.</li> <li>- Acabados de primera calidad.</li> </ul> <p>Ref.: HE-101</p> <p>118<sup>00</sup>€</p>	
 <p>TKD</p>	<p><b>Manómetro</b> para aire de empuje:</p> <ul style="list-style-type: none"> <li>- Conexión Midwest 4 y Midwest 4 LUX</li> <li>- Doble escala de medición en PSI y bares.</li> <li>- Uso en todos los equipos.</li> <li>- Instrumento de primera calidad y precisión.</li> <li>- Uso: medición de presión de aire de empuje.</li> </ul> <p>Ref.: HE-208</p> <p>145<sup>80</sup>€</p>	



# HERRAMIENTAS DE REPARACIÓN TURBINAS Y CONTRA-ÁNGULOS

Herramientas de reparación turbinas y contra-ángulos

RUMAR

	Descripción	Observaciones
	<p><b>Prensa de precisión</b></p> <ul style="list-style-type: none"> <li>- Capacidad hasta 1,5kN.</li> <li>- Recorrido 40mm.</li> <li>- Altura de trabajo 50 – 240mm.</li> <li>- Medidas de la mesa: 110 x 60mm.</li> <li>- Orificio en la base: 20mm.</li> <li>- Alojamiento del eje: diámetro 10 x 25mm.</li> <li>- Peso: aprox. 9kg.</li> </ul> <p>Ref.: HE-2010</p>	<p><b>Nota:</b> herramientas HE-1031 y HE-1032 son necesarias para el uso de la prensa.</p> <p>498<sup>00</sup>€</p>
	<p><b>Extractor de rodamientos turbina</b>  <b>Diámetro exterior:</b> 6,350mm (universal) y pista interna con todos sus accesorios</p> <p>Ref.: HE-1011</p>	<p>198<sup>00</sup>€</p>
	<p><b>Pinza pista externa</b> para extractor HE-1011</p> <p>Ref.: HE-1011L</p>	<p>54<sup>80</sup>€</p>
	<p><b>Pinza pista interna</b> para extractor HE-1011</p> <p>Ref.: HE-1011S</p>	<p>54<sup>80</sup>€</p>
 <small>Imagen no disponible</small>	<p><b>Tornillo ataque delantero</b> para extractor HE-1011</p> <p>Ref.: HE-1011SC</p>	<p>48<sup>00</sup>€</p> <p>HASTA AGOTAR</p>
 <small>Imagen no disponible</small>	<p><b>Tornillo ataque trasero</b> para extractor HE-1011</p> <p>Ref.: HE-1011SO</p>	<p>48<sup>00</sup>€</p> <p>HASTA AGOTAR</p>
	<p><b>Extractor de rodamientos de turbina</b>  <b>Diámetro exterior:</b> 6,350mm (universal)  <b>Diámetro exterior:</b> 7,938mm (Bora y compatibles)  Pista interna con todos sus accesorios</p> <p>Ref.: HE-260</p>	<p>168<sup>00</sup>€</p>



	Descripción	Observaciones												
	<p><b>Bloque universal</b> de colocación y extracción de rodamientos</p> <p>Ref.: HE-1012 <span style="float: right;">188<sup>80</sup>€</span></p>													
 <small>Imagen no disponible</small>	<p><b>Colocador de rodamientos universal</b> para rodamientos 3,175 x 6,350 mm</p> <p>Ref.: HE-1013 <span style="float: right;">43<sup>80</sup>€</span></p>	<p>HASTA AGOTAR</p>												
	<p><b>Punta ataque trasero</b> para prensa HE-2010</p> <p>Ref.: HE-1031 <span style="float: right;">42<sup>80</sup>€</span></p>													
	<p><b>Punta ataque delantero</b> para prensa HE-2010</p> <p>Ref.: HE-1032 <span style="float: right;">42<sup>80</sup>€</span></p>													
	<p><b>Llave dinamométrica</b> para tapas cabezas y tapas spray</p> <p>Ref.: HE-2025 <span style="float: right;">118<sup>00</sup>€</span></p>	<p>Regulable: 0,3 – 1,2 Nw</p> <p style="text-align: right;">BAJO PEDIDO</p>												
	<p><b>Llave dinamométrica</b> para anillos cierre contra ángulos y piezas de mano</p> <p>Ref.: HE-2026 <span style="float: right;">118<sup>00</sup>€</span></p>	<p>Regulable: 1,2 – 3,0 Nw</p> <p style="text-align: right;">BAJO PEDIDO</p>												
	<p><b>Pletina de extracción</b> rodamientos de turbinas</p> <p>Ref.: HE-750 <span style="float: right;">8<sup>80</sup>€</span></p>													
	<p><b>Placa extracción</b> de rodamientos turbinas</p> <p>Ref.: HE-2018 <span style="float: right;">48<sup>80</sup>€</span></p>													
	<p><b>Placa extracción de rodamientos universal:</b></p> <table border="0" style="width: 100%;"> <tr> <td>1,0mm</td> <td>3,0mm</td> <td>5,0 mm</td> </tr> <tr> <td>1,5 mm</td> <td>3,5 mm</td> <td>6,5 mm</td> </tr> <tr> <td>2,0 mm</td> <td>4,0 mm</td> <td>7,0 mm</td> </tr> <tr> <td>2,5 mm</td> <td>4,5 mm</td> <td></td> </tr> </table> <p>Ref.: HE-2017 <span style="float: right;">157<sup>80</sup>€</span></p>	1,0mm	3,0mm	5,0 mm	1,5 mm	3,5 mm	6,5 mm	2,0 mm	4,0 mm	7,0 mm	2,5 mm	4,5 mm		
1,0mm	3,0mm	5,0 mm												
1,5 mm	3,5 mm	6,5 mm												
2,0 mm	4,0 mm	7,0 mm												
2,5 mm	4,5 mm													
	<p><b>Pegamento</b> LOCTITE® 648 10ml</p> <p>Ref.: HE-648 <span style="float: right;">29<sup>80</sup>€</span></p>	<p>Rodamientos – ejes</p> <p style="text-align: right;">HASTA AGOTAR</p>												

	Descripción	Observaciones
	<p><b>Pegamento</b> LOCTITE® 221 10ml</p> <p>Ref.: <b>HE-221</b></p> <p><b>28<sup>00</sup>€</b></p>	<p>Tapas y tornillos</p> <p><b>HASTA AGOTAR</b></p>
	<p><b>Puntero de acero</b> con guía de hierro.</p> <p>Ref.: <b>HE-29523</b></p> <p><b>10<sup>80</sup>€</b></p>	<p>Especial para pasadores <b>Diámetro:</b> 1mm</p>
	<p><b>Pinza de Baquelita</b> para sujeción de piezas rotatorio sin rayaduras.</p> <p>Ref.: <b>HE-760</b></p> <p><b>54<sup>80</sup>€</b></p>	

# HERRAMIENTAS DE DESATASCO

Smart Cleaner®

RUMAR

	Descripción	Observaciones
	<p>Herramienta especial para desatascar todo tipo de rotatorios y mangueras de turbinas.</p> <ul style="list-style-type: none"> <li>- Trabaja con presiones de hasta 40 bares.</li> <li>- Completo con todos los accesorios:                             <ul style="list-style-type: none"> <li>* Conexión Midwest 4 con luz para acoplamiento, turbinas, micromotores y otros.</li> <li>* Conector sistema INTRA para contra-ángulos y piezas de mano.</li> <li>* Conector para mangueras de turbina!!! **</li> <li>* Accesorio para turbinas con varios orificios de spray.</li> </ul> </li> </ul>	<p><b>** Nota a nuestros clientes:</b> Es posible que encuentren el Smart Cleaner® más barato en algunos competidores. Por lo general, es porque NO incluyen el adaptador para mangueras de turbina.</p> <p><b>¡Asegúrense de consultarlo antes!</b></p>
	<p>Anillo tórico pistón Smart Cleaner®</p>	

Ref.: HE-020

338<sup>00</sup>€

Ref.: HE-021

0<sup>80</sup>€

# EMBALAJES



Embalajes

RUMAR

NUEVO DISEÑO

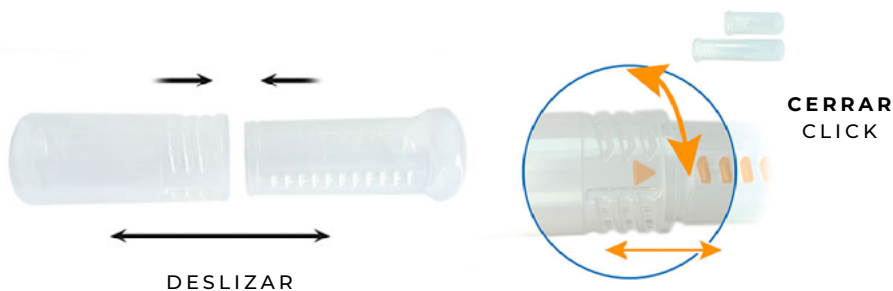
QUICK LOCK



	Descripción	Observaciones
	<p>Tubo embalaje instrumentos transparente (SIN LOGOS)</p> <p>Más fácil, rápido y seguro Precios especiales por packs 100 uds.</p>	<p>Longitud: 80-120mm Diámetro: 26mm</p>
	<p>Tubo embalaje instrumentos transparente (SIN LOGOS)</p> <p>Más fácil, rápido y seguro Precios especiales por packs 100 uds.</p>	<p>Longitud: 120-200mm Diámetro: 24mm</p>

Ref.: 01-26080

1<sup>10</sup>€

Ref.: 01-24120

1<sup>20</sup>€

Precios especiales por packs 100 uds.

SI NO ENCUENTRAS EL REPUESTO QUE BUSCAS, ¡CONSÚLTANOS!  
Precios: impuestos, portes y mano de obra no incluidos.